

Алматы (7273)495-231
Ангарск (3955)60-70-56
Архангельск (8182)63-90-72
Астрахань (8512)99-46-04
Барнаул (3852)73-04-60
Белгород (4722)40-23-64
Благовещенск (4162)22-76-07
Брянск (4832)59-03-52
Владивосток (423)249-28-31
Владикавказ (8672)28-90-48
Владимир (4922)49-43-18
Волгоград (844)278-03-48
Вологда (8172)26-41-59
Воронеж (473)204-51-73
Екатеринбург (343)384-55-89

Иваново (4932)77-34-06
Ижевск (3412)26-03-58
Иркутск (395)279-98-46
Казань (843)206-01-48
Калининград (4012)72-03-81
Калуга (4842)92-23-67
Кемерово (3842)65-04-62
Киров (8332)68-02-04
Коломна (4966)23-41-49
Кострома (4942)77-07-48
Краснодар (861)203-40-90
Красноярск (391)204-63-61
Курск (4712)77-13-04
Курган (3522)50-90-47
Липецк (4742)52-20-81

Магнитогорск (3519)55-03-13
Москва (495)268-04-70
Мурманск (8152)59-64-93
Набережные Челны (8552)20-53-41
Нижегород (831)429-08-12
Новокузнецк (3843)20-46-81
Новосибирск (383)227-86-73
Омск (3812)21-46-40
Орел (4862)44-53-42
Оренбург (3532)37-68-04
Пенза (8412)22-31-16
Петрозаводск (8142)55-98-37
Псков (8112)59-10-37
Пермь (342)205-81-47

Ростов-на-Дону (863)308-18-15
Рязань (4912)46-61-64
Самара (846)206-03-16
Санкт-Петербург (812)309-46-40
Саратов (845)249-38-78
Севастополь (8692)22-31-93
Саранск (8342)22-96-24
Симферополь (3652)67-13-56
Смоленск (4812)29-41-54
Сочи (862)225-72-31
Ставрополь (8652)20-65-13
Сургут (3462)77-98-35
Сыктывкар (8212)25-95-17
Тамбов (4752)50-40-97
Тверь (4822)63-31-35

Тольятти (8482)63-91-07
Томск (3822)98-41-53
Тула (4872)33-79-87
Тюмень (3452)66-21-18
Ульяновск (8422)24-23-59
Улан-Удэ (3012)59-97-51
Уфа (347)229-48-12
Хабаровск (4212)92-98-04
Чебоксары (8352)28-53-07
Челябинск (351)202-03-61
Череповец (8202)49-02-64
Чита (3022)38-34-83
Якутск (4112)23-90-97
Ярославль (4852)69-52-93

Россия +7(495)268-04-70

Казахстан +7(7172)727-132

Киргизия +996(312)96-26-47

<https://mac.nt-rt.ru> || mcp@nt-rt.ru

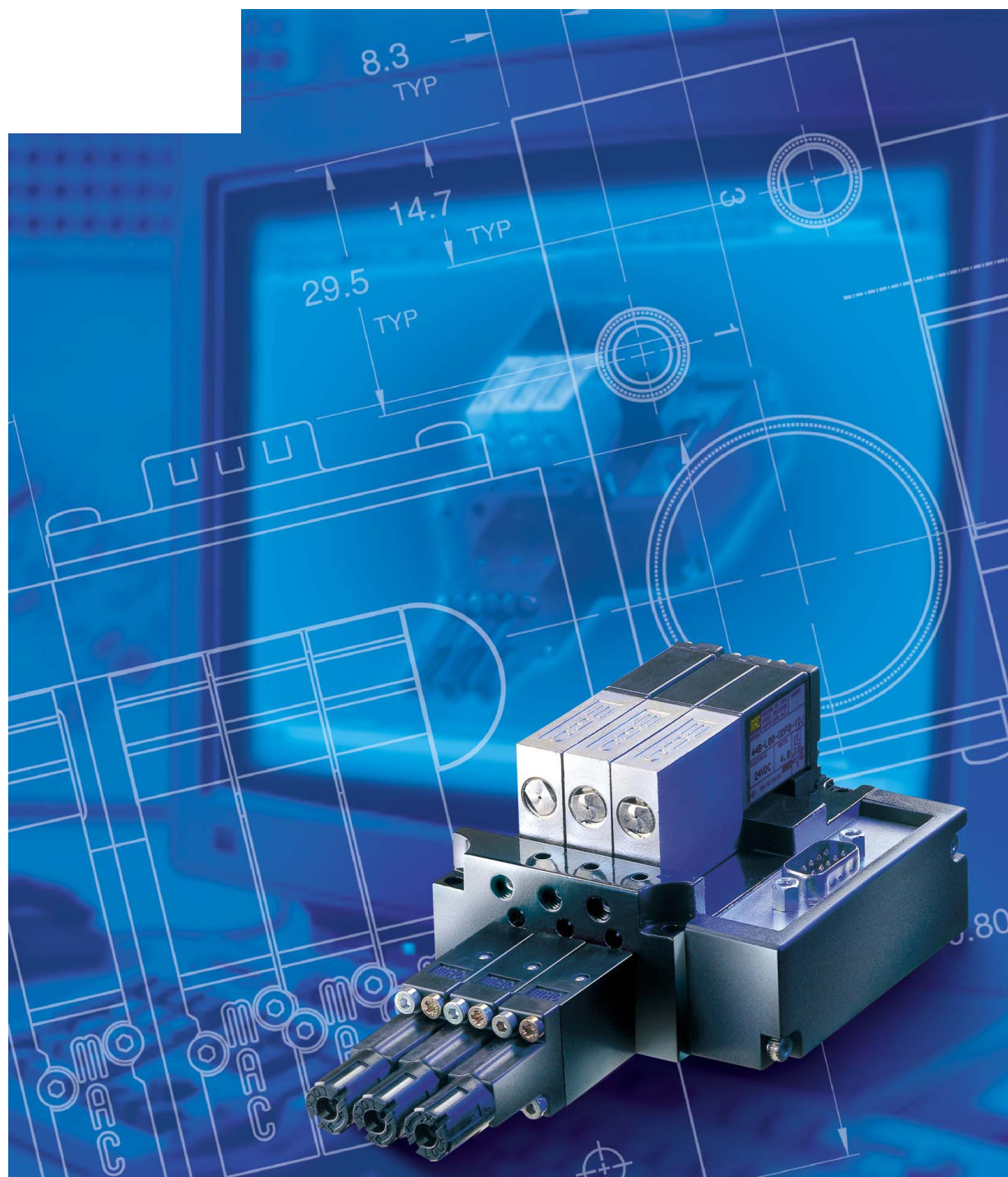

С и р с и т В а р ®



CIRCUIT BAR®

CIRCUIT BAR® is an extruded block of aluminum with pneumatic circuits machined right in the bar. The design of these circuits can be very simple or complex depending upon the requirements of the application.

CIRCUIT BAR® are a means by which individual components (i.e. valves, regulators and flow controls) comprising a circuit, can be combined into one extruded CIRCUIT BAR®. The CIRCUIT BAR® will eliminate extra piping and fittings, as well as saving space and money.

Contact your local MAC distributor for more information as to how MAC'S CIRCUIT BAR® can satisfy your needs.

Introduction

Section 1 Direct solenoid and solenoid pilot operated valves

Let us show you via high performance demonstration kits and animated software,

HOW MAC'S PERFORMANCE ADVANTAGES HELP MAKE YOUR EQUIPMENT MORE RELIABLE - FASTER - MORE REPEATABLE.



TLD

Traveling Lab Demonstration measures critical valve performance characteristics - *Shifting forces, Response Time, Speed, Repeatability and Flow.*

PLD

Proportional Lab Demonstration measures critical proportional regulation characteristics - *Response Time, Accuracy, Hysterisis, Repeatability and Flow.*



Animation

Animated Software shows inner workings of various Air Valves Designs - *Powerful educational tool for learning about how air valves function.*

3-way solenoid operated valves

#10-32 to 2 1/2" port size Cv .10 to 65.0



4-way solenoid operated valves

#10-32 to 1 1/2" port size Cv .10 to 15.9

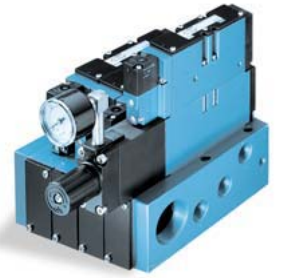
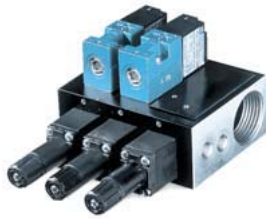

Proportional pressure control valves

Stand alone or Multi-Pressure Pak[®]

Analog or Digital with an overall accuracy range of $\pm 0.5\%$ to $\pm 2.5\%$ of full scale



Field bus products

Communication Electronics with a variety of MAC Valves' products
Input and Output capability with a variety of protocols

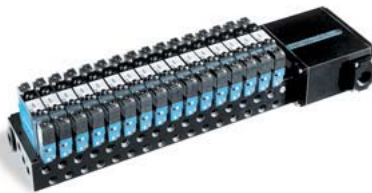



Section 1

Direct solenoid and solenoid pilot operated valves



Direct solenoid and solenoid pilot operated valves

Function	Port size	Flow (Max) C _v	Circuit bar mounting									Series
			non plug-in cylinder ports in base	non plug-in cylinder ports in valve	plug-in	plug-in with F. C.	plug-in with Pr. Reg.	plug-in with Pr. Reg. and F. C.	add-on style plug-in	add-on style plug-in with F. C.	add-on style plug-in with Pr. Reg.	
3/2	M5 - #10-32	0.11										34
3/2	#10-32 - 1/8"	0.11										
3/2	M5 - #10-32	0.10										
3/2	M5 - #10-32	0.09										35
3/2	1/8" NPTF - #10-32 UNF	0.10										
3/2	1/4" - 3/8"	0.5										
3/2	1/8" - 1/4", 6mm tube receptacle	0.5										37
3/2	1/8" - 1/4"	0.5										
5/2 - 3/2	M5 - #10-32	0.093										
5/2 - 3/2	#10-32 - 1/8"	0.093										44
5/2 - 3/2	M5 - #10-32	0.09										
5/2 - 3/2	M5 - #10-32	0.08										
5/2 - 3/2	M5 - #10-32	0.07										
4/2	1/8" NPTF - #10-32 UNF	0.10										45
5/2	1/8" - 1/4", 6mm tube receptacle	0.5										
5/2	1/8" - 1/4"	0.5										
5/2	1/8" - 1/4"	0.5										47



Direct solenoid and solenoid pilot operated valves

Function	Port size	Flow [Max] C _v	Circuit bar mounting										Series	
			add-on style plug-in with Pr. Reg. and F. C.	plug-in add-a-unit stations	plug-in add-a-unit stations with F. C.	plug-in add-a-unit stations with Pr. Reg.	plug-in add-a-unit stations with F. C. and Pr. Reg.	plug-in with pre-wired connector	plug-in with F. C. and pre-wired connector	plug-in with Pr. Reg. and pre-wired connector	din rail, plug-in with pre-wired connector			
3/2	M5 - #10-32	0.10												
3/2	M5 - #10-32	0.09												34
3/2	M5 - #10-32, 4mm tube receptacle	0.11												
3/2	1/8" - 1/4", 6mm tube receptacle	0.5												
3/2	1/8" - 1/4"	0.5												37
5/2 - 3/2	M5 - #10-32	0.09												
5/2 - 3/2	M5 - #10-32	0.07												
5/2	M5 - #10-32	0.09												
5/2	M5 - #10-32	0.08												44
5/2	M5 - #10-32	0.07												
5/2 - 3/2	M5 - #10-32, 4mm tube receptacle	0.10												
5/2	1/8" - 1/4", 6mm tube receptacle	0.5												
5/2	1/8" - 1/4"	0.5												47

Function	Port size	Flow [Max] C _v	Circuit bar mounting										Series	
			din rail, plug-in with F. C. and pre-wired connector	non plug-in	non plug-in with Pr. Reg.	plug-in with side Pr. Reg.	plug-in with integral terminal strip	plug-in with integral terminal strip and side Pr. Reg.	non plug-in cylinder ports in base with Pr. Reg.	non plug-in add-on style cylinder ports in base	non plug-in add-a-unit stations			
3/2	M5 - #10-32, 4mm tube receptacle	0.11												34
3/2	1/8" NPTF - #10-32 UNF	0.10												35
3/2	1/8" - 1/4", 6mm tube receptacle	0.5												37
4/2	1/8" NPTF - #10-32 UNF	0.10												45
5/2	1/8" - 1/4", 6mm tube receptacle	0.5												47



Direct solenoid and solenoid pilot operated valves

Function	Port size	Flow [Max] C _v	Circuit bar mounting							Series			
			cylinder ports in valve	add-on style cylinder ports in valve	cylinder ports in base	add-on style cylinder ports in base	add-a-unit stations for CBM052A bar	add-a-unit stations for CBP052A bar	non plug-in with or without F. C.		non plug-in with Pr. Reg. and F. C.	plug-in with sandwich Pr. Reg.	
3/2	1/8" - 1/4"	1.2											52
4/2	1/8" NPTF - #10-32 UNF	0.10											45
5/2 - 5/3	1/4"	1.3											800

Function	Port size	Flow [Max] C _v	Circuit bar mounting							Series			
			plug-in with integral terminal strip and sandwich Pr. Reg.	plug-in with integral terminal strip with F. C.	plug-in with integral terminal strip with Pr. Reg. and F. C.	non plug-in cyl. ports in valve with opt. F. C.	non plug-in cyl. ports in base with opt. F. C.	add-on style non plug-in cyl. ports in valve with opt. F. C.	add-on style non plug-in cyl. ports in base with opt. F. C.		non plug-in cyl. ports in valve with opt. Pr. Reg.	add-on style non plug-in cyl. ports in base	
4/2	1/8" NPTF - #10-32 UNF	0.10											45
5/2	3/8"	0.5											47
5/2	1/8" - 1/4", 6mm tube receptacle	0.5											47

Function	Port size	Flow [Max] C _v	Circuit bar mounting							Series			
			add-on style non plug-in cyl. ports in base with Pr. Reg.	low profile cylinder ports in valve	low profile cylinder ports in base	mid profile cylinder ports in valve	mid profile - add on style cylinder ports in valve	add-a-unit stations for CBM403A bar	mid profile cylinder ports in base		mid profile - add on style cylinder ports in base	add-a-unit stations for CBM404A bar	
5/2	1/8" - 1/4", 6mm tube receptacle	0.5											47
5/2 - 5/3	1/8" - 1/4"	1.0											400
5/2 - 5/3	1/8"	1.0											400

Function	Port size	Flow [Max] C _v	Circuit bar mounting							Series		
			high profile cylinder ports in base	high profile - add on style cylinder ports in base	add-a-unit stations for CBM405A bar	standard	add-on style	add-a-unit stations for CBM092B	with shut-off valve			
5/2 - 5/3	1/8" - 1/4"	1.0										400
5/2 - 5/3 - 3/2	1/8 - 1/4 - 3/8	1.0										92
5/2 - 5/3	1/4"	1.3										800

Consult "Precautions" before use, installation or service of MAC Valves.

Circuit bar mounting

non plug-in cylinder ports in base	non plug-in cylinder ports in valve	plug-in	plug-in with F. C.	plug-in with Pr. Reg.	plug-in with Pr. Reg. and F. C.	add-on style plug-in	add-on style plug-in with F. C.
add-on style plug-in with Pr. Reg.	add-on style plug-in with Pr. Reg. and F. C.	plug-in add-a-unit stations	plug-in add-a-unit stations with F. C.	plug-in add-a-unit stations with Pr. Reg.	plug-in add-a-unit stations with F. C. and Pr. Reg.	plug-in with pre-wired connector	plug-in with F. C. and pre-wired connector
plug-in with Pr. Reg. and pre-wired connector	din rail, plug-in with pre-wired connector	din rail, plug-in with F. C. and pre-wired connector					

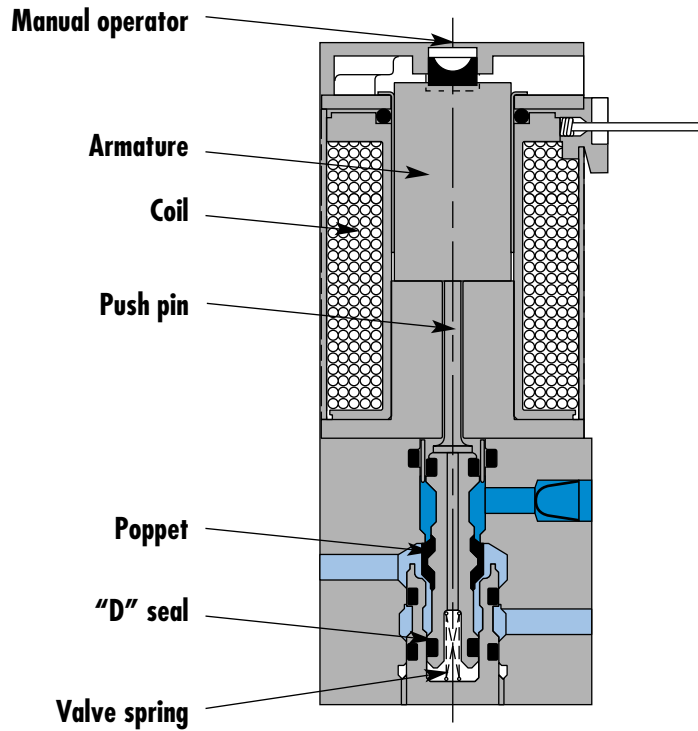

SERIES FEATURES

- High force MACSOLENOID®.
- Universal porting.
- #10-32 or M5 ports.
- Rated for lubricated or non-lubricated service.
- 10mm direct operated.
- Cylinder port in valve or in circuit bar.

Function	Port size	Flow [Max]	Circuit bar mounting
3/2 NO-NC	M5 - #10-32	0.11C_v	non plug-in cylinder ports in base

OPERATIONAL BENEFITS

1. 10 mm valve, direct solenoid operated.
2. Balanced poppet, immune to variations of pressure.
3. Short stroke with high flow.
4. The patented solenoid develops high shifting forces.
5. Powerful return spring.
6. Flow is specifically adjusted on each valve.
7. Manual operator standard on all valves.



HOW TO ORDER

34B-xxx-Gxxx-xxx

HOW TO ORDER VALVE FOR CIRCUIT BAR MOUNTING

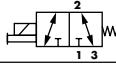
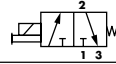
Port size (see base)	Universal valve	NC only valve
		
Pressure range : 0 to 120 PSI	<input type="radio"/> 34B-100-Gxxx-xxx	<input type="radio"/> 34B-NOO-Gxxx-xxx

SOLENOID OPERATOR >

G **XX X-X XX'**

XX Voltage	X Wire length	X Manual operator	XX Electrical connection
<input type="radio"/> DC 24VDC (1.8 W)	<input type="radio"/> A 18"	<input type="radio"/> 1 Non-locking	<input type="radio"/> KA Mini connector
<input type="radio"/> DD 24VDC (2.5 W)	<input type="radio"/> C 36"		<input type="radio"/> KT Mini connector with light
<input type="radio"/> DF 24VDC (4.0 W)	<input type="radio"/> x Other Options		<input type="radio"/> BA Flying leads
<input type="radio"/> xx Other Options			<input type="radio"/> BT Flying leads with light
			<input type="radio"/> xx Other Options

EBP34B-xxxx-xx

HOW TO ORDER CIRCUIT BAR

Port size	Side cylinder ports	Bottom cylinder ports
M5	<input type="radio"/> EBP34B-001D-xx	<input type="radio"/> EBP34B-002D-xx
# 10-32	<input type="radio"/> EBP34B-001B-xx	<input type="radio"/> EBP34B-002B-xx

Number of stations (03=3 stations)

Note : clic for valves mounted on base at the factory, add - 9 to the model number.

**TECHNICAL
DATA**

Fluid :	Compressed air, vacuum, inert gases
Pressure range :	Vacuum to 120 PSI
Lubrication :	Not required, if used select a medium aniline point lubricant (between 180°F and 210°F)
Filtration :	40 µ
Temperature range :	0°F to 120°F (-18°C to 50°C)
Orifice :	1.8 mm
Flow (at 6 bar, ΔP=1bar) :	4 W : 0.11C _v , 2.5 W : 0.084C _v , 1.8 W : 0.061C _v
Coil :	General purpose class A, continuous duty, encapsulated
Voltage range :	-15% to +10% of nominal voltage
Power :	4 W - 2.5 W - 1.8 W
Response times :	Energize : 3.4 ms
(with 4 W coil)	De-energize : 1.5 ms

- Note : • Valve and coil are not interchangeable.
- Spare parts : • Seal between valve and bar : 16595. • Mounting screw (x2) : 35031. • Blanking plate : M-34005.
- Options : • Isolation of inlet and/or exhaust. Special bar. Consult factory.

DIMENSIONS

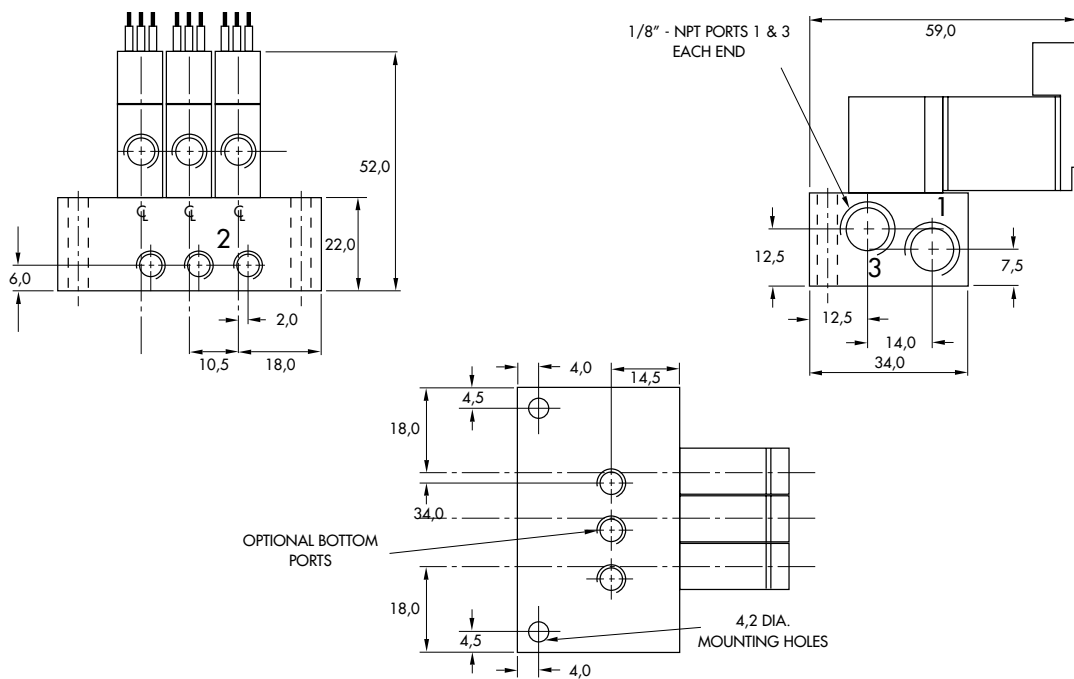

Function	Port size (Inlet & Exhaust)	Flow (Max)	Circuit bar mounting
3/2 NO-NC	# 10-32 - 1/8"	0.11C_v	non plug-in cylinder ports in valve

OPERATIONAL BENEFITS

1. 10 mm valve, direct solenoid operated.
2. Balanced poppet, immune to variations of pressure.
3. Short stroke with high flow.
4. The patented solenoid develops high shifting forces.
5. Powerful return spring.
6. Flow is specifically adjusted on each valve.
7. Manual operator standard on all valves.



HOW TO ORDER

34B-xxx-Gxxx-xxx

HOW TO ORDER VALVE FOR CIRCUIT BAR MOUNTING

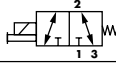
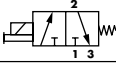
Valve port size	Universal valve	NC only valve
		
M5	<input type="radio"/> 34B-ABA-Gxxx-xxx	<input type="radio"/> 34B-ABB-Gxxx-xxx
# 10-32	<input type="radio"/> 34B-AAA-Gxxx-xxx	<input type="radio"/> 34B-AAB-Gxxx-xxx

SOLENOID OPERATOR >

G **XX X- X XX'**

XX Voltage	X Wire length	X Manual operator	XX Electrical connection
<input type="radio"/> DC 24VDC (1.8 W)	<input type="radio"/> A 18"	<input type="radio"/> 1 Non-locking	<input type="radio"/> KA Mini connector
<input type="radio"/> DD 24VDC (2.5 W)	<input type="radio"/> c 36"		<input type="radio"/> KT Mini connector with light
<input type="radio"/> DF 24VDC (4.0 W)	<input type="radio"/> x Other Options		<input type="radio"/> BA Flying leads
<input type="radio"/> xx Other Options			<input type="radio"/> BT Flying leads with light
			<input type="radio"/> xx Other Options

EBM34A-xxxx-xx

HOW TO ORDER CIRCUIT BAR

Port size COMMON INLET & EXHAUST	
# 10-32	<input type="radio"/> EBM34A-001B-xx
1/8" NPTF	<input type="radio"/> EBM34A-002A-xx

Number of stations (03=3 stations)

Note : clic for valves mounted on base at the factory, add - 9 to the model number.

**TECHNICAL
DATA**

Fluid :	Compressed air, vacuum, inert gases
Pressure range :	Vacuum to 120 PSI
Lubrication :	Not required, if used select a medium aniline point lubricant (between 180°F and 210°F)
Filtration :	40 µ
Temperature range :	0°F to 120°F (-18°C to +50°C)
Orifice :	1.8 mm
Flow (at 6 bar, ΔP=1bar) :	4 W : 0.11C _v , 2.5 W : 0.084C _v , 1.8 W : 0.061C _v
Coil :	General purpose class A, continuous duty, encapsulated
Voltage range :	-15% to +10% of nominal voltage
Power :	4 W - 2.5 W - 1.8 W
Response times :	Energize : 3.4 ms
(with 4 W coil)	De-energize : 1.5 ms

- Note : • Valve and coil are not interchangeable.
- Spare parts : • Valve fastening kit : M34001-01 (1/8" Bar); M34001-21 (#10-32 Bar) • Blanking plate : 30456-A.
- Options : • Isolation of inlet and/or exhaust. Special bar. Consult factory.

DIMENSIONS

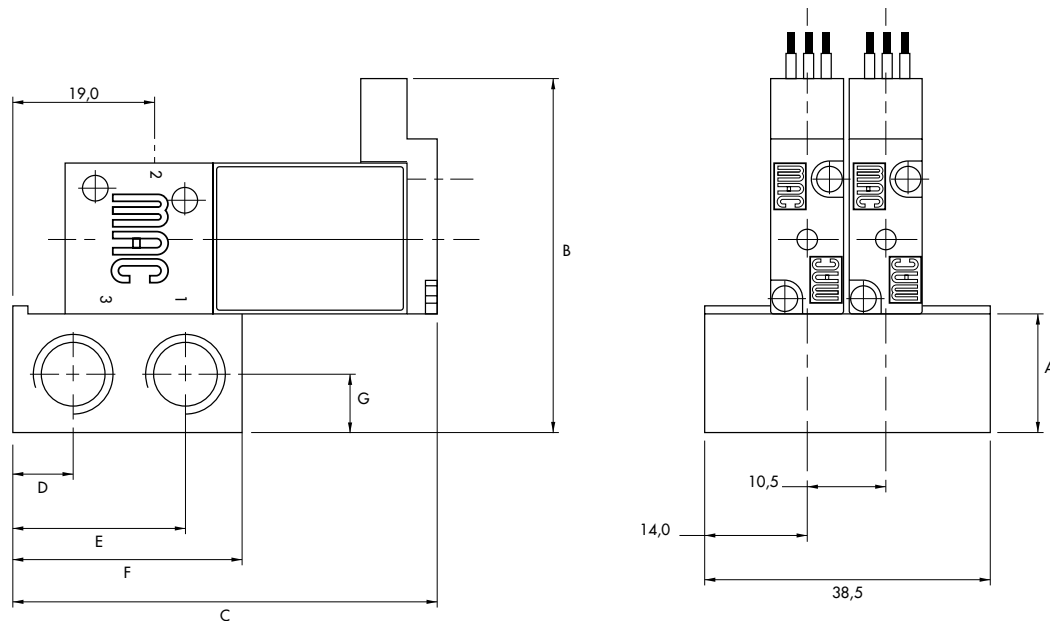

Port size	A	B	C	D	E	F	G
1/8"	16.0	47.5	57.4	8.0	23.0	31.0	8.0
M5	12.0	43.5	51.5	9.0	18.0	26.0	6.0

Function	Port size	Flow [Max]	Circuit bar mounting
3/2 NO-NC	M5 - #10-32	0.10C_v	plug-in

OPERATIONAL BENEFITS

1. 10 mm valve, direct solenoid operated.
2. Balanced poppet, immune to variations of pressure.
3. Short stroke with high flow.
4. The patented solenoid develops high shifting forces.
5. Powerful return spring.
6. Flow is specifically adjusted on each valve.
7. Manual operator standard on all valves.



Reset

HOW TO ORDER

34B-xxx-GxxO-xxx

HOW TO ORDER VALVE FOR CIRCUIT BAR MOUNTING

Port size (see base)	Universal valve	NC only valve
Valve less base	<input type="radio"/> 34B-100-GxxO-xxx	<input type="radio"/> 34B-NOO-GxxO-xxx

SOLENOID OPERATOR >

G XX O- X XX*

XX Voltage	X Manual operator	XX Electrical connection
<input type="radio"/> DC 24VDC (1.8 W)	<input type="radio"/> 1 Non-locking	<input type="radio"/> DJ Plug-in
<input type="radio"/> DD 24VDC (2.5 W)		<input type="radio"/> DT Plug-in with light
<input type="radio"/> DF 24VDC (4.0 W)		<input type="radio"/> DE Plug-in with suppression diode
<input type="radio"/> xx Other Options		<input type="radio"/> DV Plug-in with light and suppression diode
		<input type="radio"/> xx Other Options

ECD034B-00xxx-AOxx

HOW TO ORDER CIRCUIT BAR

Port size	Side cylinder ports (10.5 mm)	Bottom cylinder ports (10.5 mm)
M5	<input type="radio"/> ECD034B-001AD-AOxx	<input type="radio"/> ECD034B-002AD-AOxx
# 10-32	<input type="radio"/> ECD034B-001AB-AOxx	<input type="radio"/> ECD034B-002AB-AOxx

Number of stations (03=3 stations)

Note : clic for valves mounted on base at the factory, add - 9 to the model number.
 clic for multi-pin connector option (9, 15 or 25).

**TECHNICAL
DATA**

Fluid :	Compressed air, vacuum, inert gases
Pressure range :	Vacuum to 120 PSI
Lubrication :	Not required, if used select a medium aniline point lubricant (between 180°F and 210°F)
Filtration :	40 µ
Temperature range :	0°F to 120°F (-18°C to +50°C)
Orifice :	1.8 mm
Flow (at 6 bar, ΔP=1bar) :	4 W : 0.10C _v , 2.5 W : 0.09C _v , 1.8 W : 0.07C _v
Coil :	General purpose class A, continuous duty, encapsulated
Voltage range :	-15% to +10% of nominal voltage
Power :	4 W - 2.5 W - 1.8 W
Response times :	Energize : 4 ms
(with 4 W coil)	De-energize : 1.5 ms

- Note : • Valve and coil are not interchangeable.
- Spare parts : • Seal between valve and bar : 16595. • Mounting screw (x2) : 35031. • Blanking plate : M-34005.
• Base wire Plug-in protector : 24180.
- Options : • Isolation of inlet and/or exhaust. • BSPP Threads.

DIMENSIONS

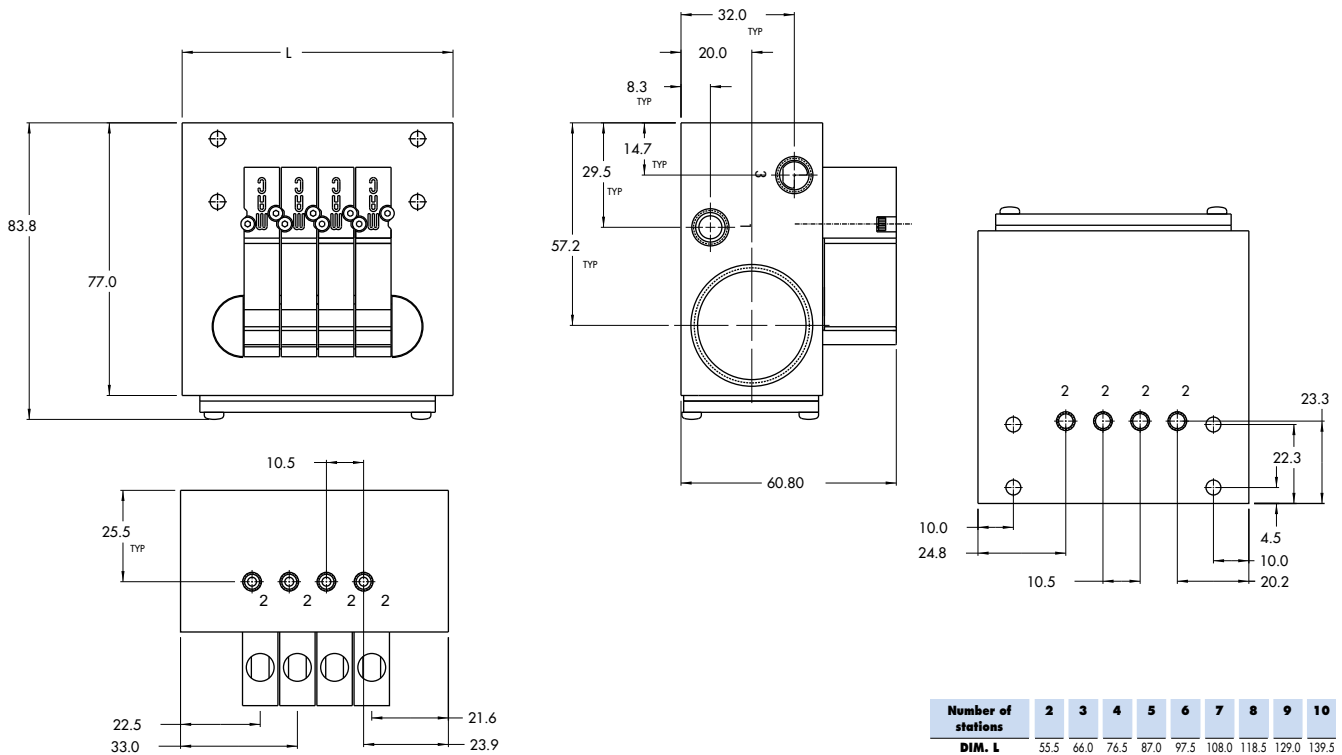

Function	Port size	Flow [Max]	Circuit bar mounting
3/2 NO-NC	M5 - #10-32	0.10C_v	plug-in with F. C.

OPERATIONAL BENEFITS

1. 10 mm valve, direct solenoid operated.
2. Balanced poppet, immune to variations of pressure.
3. Short stroke with high flow.
4. The patented solenoid develops high shifting forces.
5. Powerful return spring.
6. Flow is specifically adjusted on each valve.
7. Manual operator standard on all valves.



HOW TO ORDER

34B-xxx-GxxO-xxx

HOW TO ORDER VALVE FOR CIRCUIT BAR MOUNTING

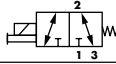
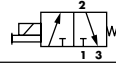
Port size (see base)	Universal valve	NC only valve
		
Valve less base	<input type="radio"/> 34B-100-GxxO-xxx	<input type="radio"/> 34B-NOO-GxxO-xxx

SOLENOID OPERATOR >

G **XX** O- **X** **XX** *

XX Voltage	X Manual operator	XX Electrical connection
<input type="radio"/> DC 24VDC (1.8 W)	<input type="radio"/> 1 Non-locking	<input type="radio"/> DJ Plug-in
<input type="radio"/> DD 24VDC (2.5 W)		<input type="radio"/> DT Plug-in with light
<input type="radio"/> DF 24VDC (4.0 W)		<input type="radio"/> DE Plug-in with suppression diode
<input type="radio"/> xx Other Options		<input type="radio"/> DV Plug-in with light and suppression diode
		<input type="radio"/> xx Other Options

HOW TO ORDER CIRCUIT BAR WITH FLOW CONTROLS

ECD034B-00xxx-AOxx

Port size	Side cylinder ports (10.5 mm)	Bottom cylinder ports (10.5 mm)
M5	<input type="radio"/> ECD034B-005AD-AOxx	<input type="radio"/> ECD034B-006AD-AOxx
# 10-32	<input type="radio"/> ECD034B-005AB-AOxx	<input type="radio"/> ECD034B-006AB-AOxx

Number of stations (03=3 stations)

Note : clic for valves mounted on base at the factory, add - 9 to the model number.
 clic for multi-pin connector option (9, 15 or 25).

**TECHNICAL
DATA**

Fluid :	Compressed air, vacuum, inert gases
Pressure range :	Vacuum to 120 PSI
Lubrication :	Not required, if used select a medium aniline point lubricant (between 180°F and 210°F)
Filtration :	40 µ
Temperature range :	0°F to 120°F (-18°C to +50°C)
Orifice :	1.8 mm
Flow (at 6 bar, ΔP=1bar) :	4 W : 0.10C _v , 2.5 W : 0.09C _v , 1.8 W : 0.07C _v
Coil :	General purpose class A, continuous duty, encapsulated
Voltage range :	-15% to +10% of nominal voltage
Power :	4 W - 2.5 W - 1.8 W
Response times :	Energize : 4 ms
(with 4 W coil)	De-energize : 1.5 ms

- Note : • Valve and coil are not interchangeable.
- Spare parts : • Seal between valve and bar : 16595. • Mounting screw (x2) : 35031. • Blanking plate : M-34005.
• Base wire Plug-in protector : 24180.
- Options : • Isolation of inlet and/or exhaust. • BSPP Threads.

DIMENSIONS

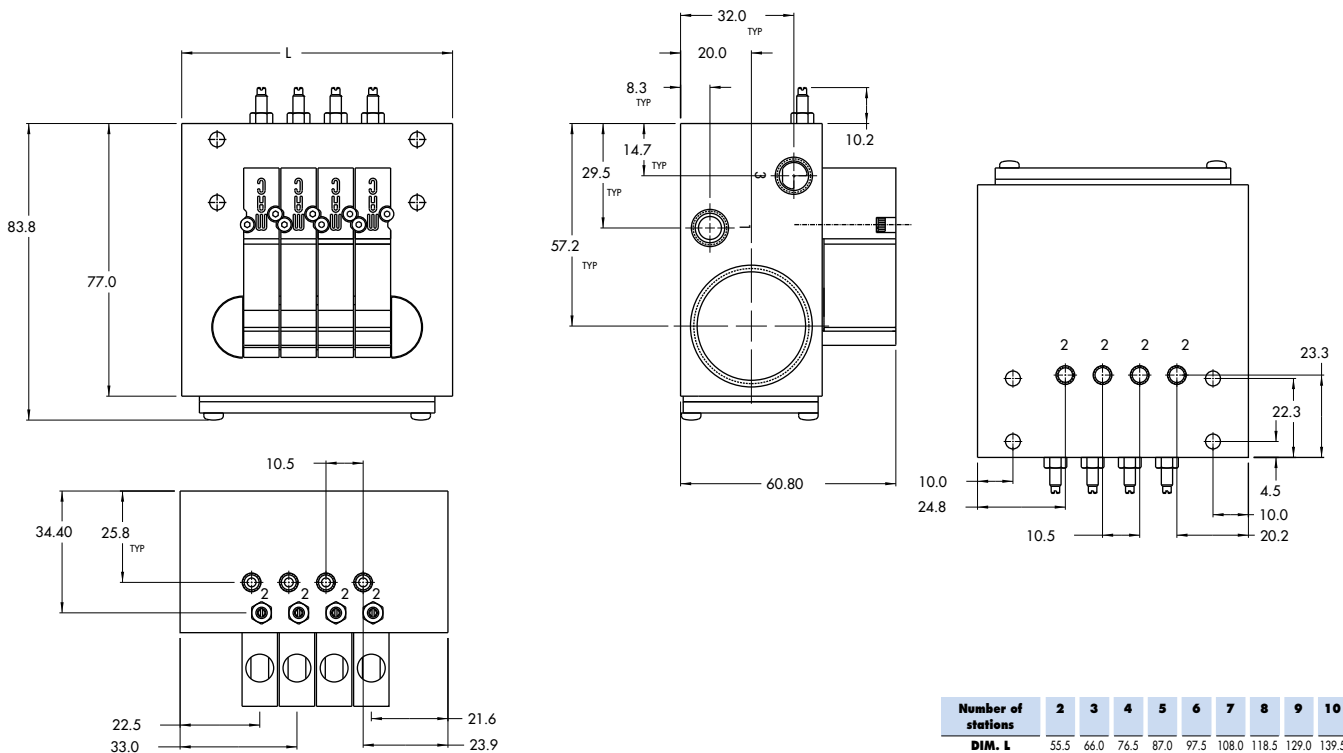

Function	Port size	Flow [Max]	Circuit bar mounting
3/2 NO-NC	M5 - #10-32	0.10C_v	plug-in with Pr. Reg.

OPERATIONAL BENEFITS

1. 10 mm valve, direct solenoid operated.
2. Balanced poppet, immune to variations of pressure.
3. Short stroke with high flow.
4. The patented solenoid develops high shifting forces.
5. Powerful return spring.
6. Flow is specifically adjusted on each valve.
7. Manual operator standard on all valves.



HOW TO ORDER

34B-xxx-GxxO-xxx

HOW TO ORDER VALVE FOR CIRCUIT BAR MOUNTING

Port size (see base)	Universal valve	NC only valve
Valve less base	<input type="radio"/> 34B-100-GxxO-xxx	<input type="radio"/> 34B-N00-GxxO-xxx

SOLENOID OPERATOR >

G XX O - X XX*

XX Voltage	X Manual operator	XX Electrical connection
<input type="radio"/> DC 24VDC (1.8 W)	<input type="radio"/> 1 Non-locking	<input type="radio"/> DJ Plug-in
<input type="radio"/> DD 24VDC (2.5 W)		<input type="radio"/> DT Plug-in with light
<input type="radio"/> DF 24VDC (4.0 W)		<input type="radio"/> DE Plug-in with suppression diode
<input type="radio"/> xx Other Options		<input type="radio"/> DV Plug-in with light and suppression diode
		<input type="radio"/> xx Other Options

ECD034B-00xxx-AOxx

HOW TO ORDER CIRCUIT BAR FOR PRESSURE REGULATORS ** (to be ordered separately)

Port size	Bottom cylinder ports (10.5 mm)	Side cylinder ports (10.5 mm)
M5	<input type="radio"/> ECD034B-004AD-AOxx	<input type="radio"/> ECD034B-003AD-AOxx
# 10-32	<input type="radio"/> ECD034B-004AB-AOxx	<input type="radio"/> ECD034B-003AB-AOxx

Number of stations (03=3 stations)

Note : clic for valves mounted on base at the factory, add - 9 to the model number.
 clic for multi-pin connector option (9, 15 or 25).

** Pressure Regulators :

PR44A-AOxx

- Y=A (no gage port)
- Y=B (with gage port)
- X=A (0 to 100 PSI)
- X=B (0 to 60 PSI)
- X=C (0 to 40 PSI)
- X=D (0 to 15 PSI)

**TECHNICAL
DATA**

Fluid :	Compressed air, vacuum, inert gases
Pressure range :	Vacuum to 120 PSI
Lubrication :	Not required, if used select a medium aniline point lubricant (between 180°F and 210°F)
Filtration :	40 µ
Temperature range :	0°F to 120°F (-18°C to +50°C)
Orifice :	1.8 mm
Flow (at 6 bar, ΔP=1bar) :	4 W : 0.10C _v , 2.5 W : 0.09C _v , 1.8 W : 0.07C _v
Coil :	General purpose class A, continuous duty, encapsulated
Voltage range :	-15% to +10% of nominal voltage
Power :	4 W - 2.5 W - 1.8 W
Response times :	Energize : 4 ms
(with 4 W coil)	De-energize : 1.5 ms

- Note : • Valve and coil are not interchangeable.
- Spare parts : • Seal between valve and bar : 16595. • Mounting screw (x2) : 35031. • Blanking plate : M-34005.
• Blanking plate for regulator : N-44003. • Base wire Plug-in protector : 24180.
- Options : • Isolation of inlet and/or exhaust. • BSPP Threads.

DIMENSIONS

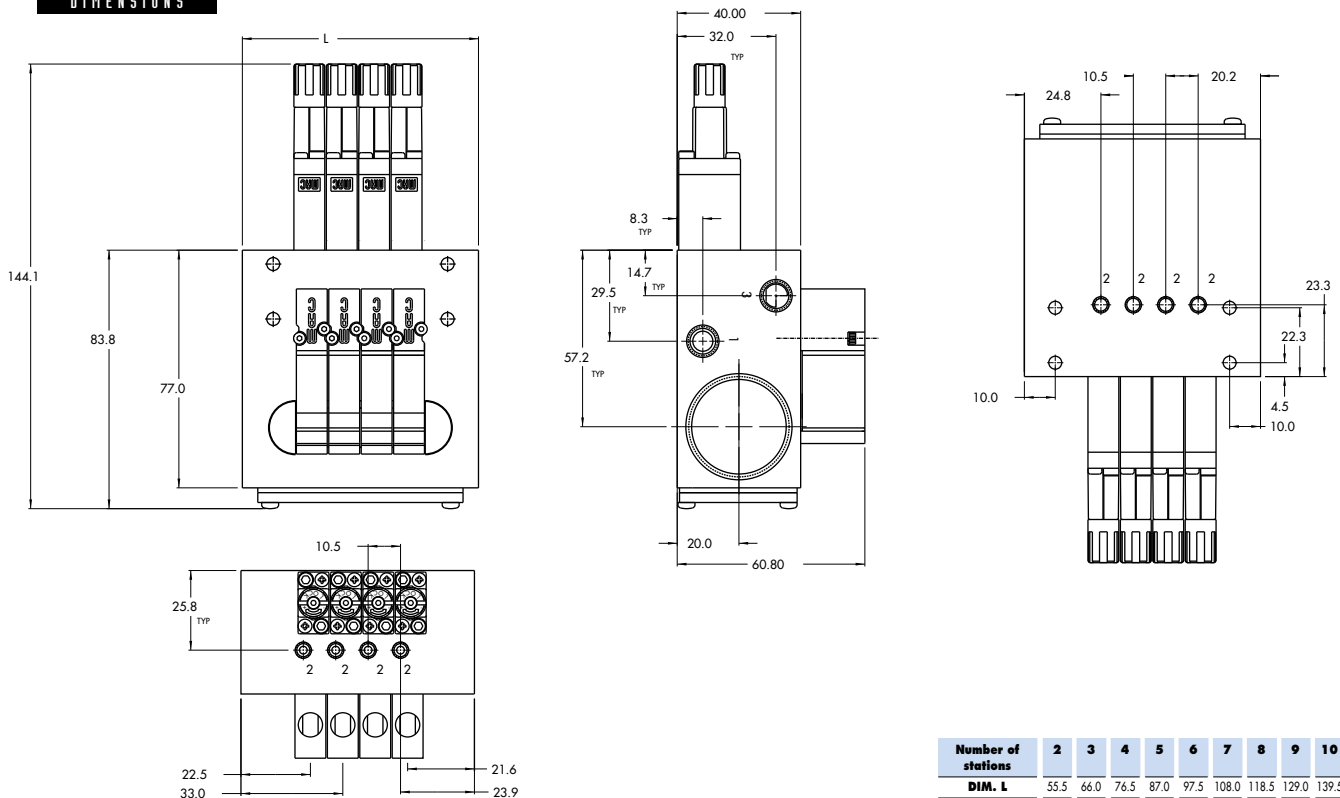

Number of stations	2	3	4	5	6	7	8	9	10
DIM. L	55.5	66.0	76.5	87.0	97.5	108.0	118.5	129.0	139.5

Function	Port size	Flow [Max]	Circuit bar mounting
3/2 NO-NC	M5 - #10-32	0.09C_v	plug-in with Pr. Reg. and F. C.

OPERATIONAL BENEFITS

1. 10 mm valve, direct solenoid operated.
2. Balanced poppet, immune to variations of pressure.
3. Short stroke with high flow.
4. The patented solenoid develops high shifting forces.
5. Powerful return spring.
6. Flow is specifically adjusted on each valve.
7. Manual operator standard on all valves.

Reset

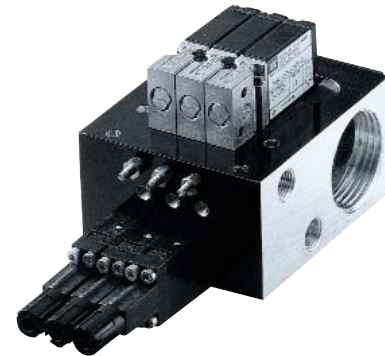

HOW TO ORDER

34B-xxx-GxxO-xxx

HOW TO ORDER VALVE FOR CIRCUIT BAR MOUNTING

Port size (see base)	Universal valve	NC only valve
Valve less base	<input type="radio"/> 34B-100-GxxO-xxx	<input type="radio"/> 34B-NOO-GxxO-xxx

SOLENOID OPERATOR

G XX O - X XX*

XX Voltage	X Manual operator	XX Electrical connection
<input type="radio"/> DC 24VDC (1.8 W)	<input type="radio"/> 1 Non-locking	<input type="radio"/> DJ Plug-in
<input type="radio"/> DD 24VDC (2.5 W)		<input type="radio"/> DT Plug-in with light
<input type="radio"/> DF 24VDC (4.0 W)		<input type="radio"/> DE Plug-in with suppression diode
<input type="radio"/> xx Other Options		<input type="radio"/> DV Plug-in with light and suppression diode
		<input type="radio"/> xx Other Options

ECD034B-00xxx-AOxx

HOW TO ORDER CIRCUIT BAR WITH FLOW CONTROLS AND PRESSURE REGULATORS (pressure regulators to be ordered separately)**

Port size	Bottom cylinder ports (10.5 mm)	Side cylinder ports (10.5 mm)
M5	<input type="radio"/> ECD034B-007AD-AOxx	<input type="radio"/> ECD034B-008AD-AOxx
# 10-32	<input type="radio"/> ECD034B-007AB-AOxx	<input type="radio"/> ECD034B-008AB-AOxx

Number of stations (03=3 stations)
 Note: clic for valves mounted on base at the factory, add - 9 to the model number.
 clic for multi-pin connector option (9, 15 or 25).

** Pressure Regulators :

PR44A-AOxx

- Y=A (no gage port)
- Y=B (with gage port)
- X=A (0 to 100 PSI)
- X=B (0 to 60 PSI)
- X=C (0 to 40 PSI)
- X=D (0 to 15 PSI)

**TECHNICAL
DATA**

Fluid :	Compressed air, vacuum, inert gases
Pressure range :	Vacuum to 120 PSI
Lubrication :	Not required, if used select a medium aniline point lubricant (between 180°F and 210°F)
Filtration :	40 µ
Temperature range :	0°F to 120°F (-18°C to +50°C)
Orifice :	1.8 mm
Flow (at 6 bar, ΔP=1bar) :	4 W : 0.10C _v , 2.5 W : 0.09C _v , 1.8 W : 0.07C _v
Coil :	General purpose class A, continuous duty, encapsulated
Voltage range :	-15% to +10% of nominal voltage
Power :	4 W - 2.5 W - 1.8 W
Response times :	Energize : 4 ms
(with 4 W coil)	De-energize : 1.5 ms

Note :

- Valve and coil are not interchangeable.

Spare parts :

- Seal between valve and bar : 16595.
- Mounting screw (x2) : 35031.
- Blanking plate : M-34005.
- Base wire Plug-in protector : 24180.
- Blanking plate for regulator : N-44003.

Options :

- Isolation of inlet and/or exhaust.
- BSPP Threads.

DIMENSIONS

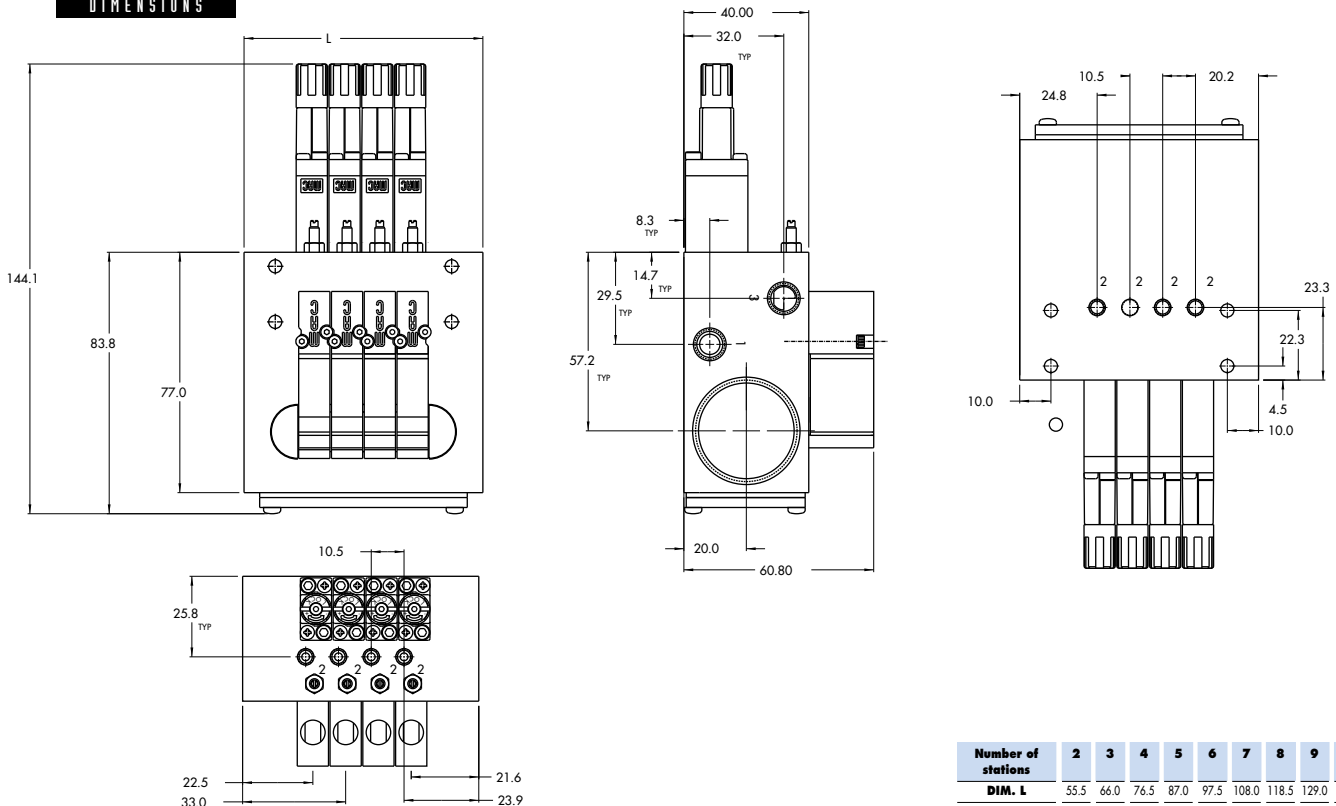

Number of stations	2	3	4	5	6	7	8	9	10
DIM. L	55.5	66.0	76.5	87.0	97.5	108.0	118.5	129.0	139.5

Function	Port size	Flow [Max]	Circuit bar mounting
3/2 NO-NC	M5 - #10-32	0.10C_v	add-on style plug-in

OPERATIONAL BENEFITS

1. 10 mm valve, direct solenoid operated.
2. Balanced poppet, immune to variations of pressure.
3. Short stroke with high flow.
4. The patented solenoid develops high shifting forces.
5. Powerful return spring.
6. Flow is specifically adjusted on each valve.
7. Manual operator standard on all valves.



HOW TO ORDER

34B-xxx-GxxO-xxx

HOW TO ORDER VALVE FOR CIRCUIT BAR MOUNTING

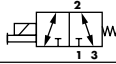
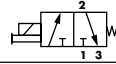
Port size (see base)	Universal valve	NC only valve
		
Valve less base	<input type="radio"/> 34B-100-GxxO-xxx	<input type="radio"/> 34B-NOO-GxxO-xxx

SOLENOID OPERATOR >

G **XX** O - **X** **XX** *

XX Voltage	X Manual operator	XX Electrical connection
<input type="radio"/> DC 24VDC (1.8 W)	<input type="radio"/> 1 Non-locking	<input type="radio"/> DJ Plug-in
<input type="radio"/> DD 24VDC (2.5 W)		<input type="radio"/> DT Plug-in with light
<input type="radio"/> DF 24VDC (4.0 W)		<input type="radio"/> DE Plug-in with suppression diode
<input type="radio"/> xx Other Options		<input type="radio"/> DV Plug-in with light and suppression diode
		<input type="radio"/> xx Other Options

ECD034B-00xxx-AOxx

HOW TO ORDER CIRCUIT BAR

Port size	Side cylinder ports (10.5 mm)	Bottom cylinder ports (10.5 mm)
M5	<input type="radio"/> ECD034B-001BD-AOxx	<input type="radio"/> ECD034B-002BD-AOxx
# 10-32	<input type="radio"/> ECD034B-001BB-AOxx	<input type="radio"/> ECD034B-002BB-AOxx

Number of stations (03=3 stations)

Note : clic for valves mounted on base at the factory, add - 9 to the model number.
 clic for multi-pin connector option (9, 15 or 25).
 add-a-unit stations may be added to above bars. Clic here for model numbers.

**TECHNICAL
DATA**

Fluid :	Compressed air, vacuum, inert gases
Pressure range :	Vacuum to 120 PSI
Lubrication :	Not required, if used select a medium aniline point lubricant (between 180°F and 210°F)
Filtration :	40 µ
Temperature range :	0°F to 120°F (-18°C to +50°C)
Orifice :	1.8 mm
Flow (at 6 bar, ΔP=1bar) :	4 W : 0.10C _v , 2.5 W : 0.09C _v , 1.8 W : 0.07C _v
Coil :	General purpose class A, continuous duty, encapsulated
Voltage range :	-15% to +10% of nominal voltage
Power :	4 W - 2.5 W - 1.8 W
Response times :	Energize : 4 ms
(with 4 W coil)	De-energize : 1.5 ms

- Note : • Valve and coil are not interchangeable.
- Spare parts : • Seal between valve and bar : 16595. • Mounting screw (x2) : 35031. • Blanking plate : M-34005.
• Base wire Plug-in protector : 24180.
- Options : • Isolation of inlet and/or exhaust. • BSPP Threads.

DIMENSIONS

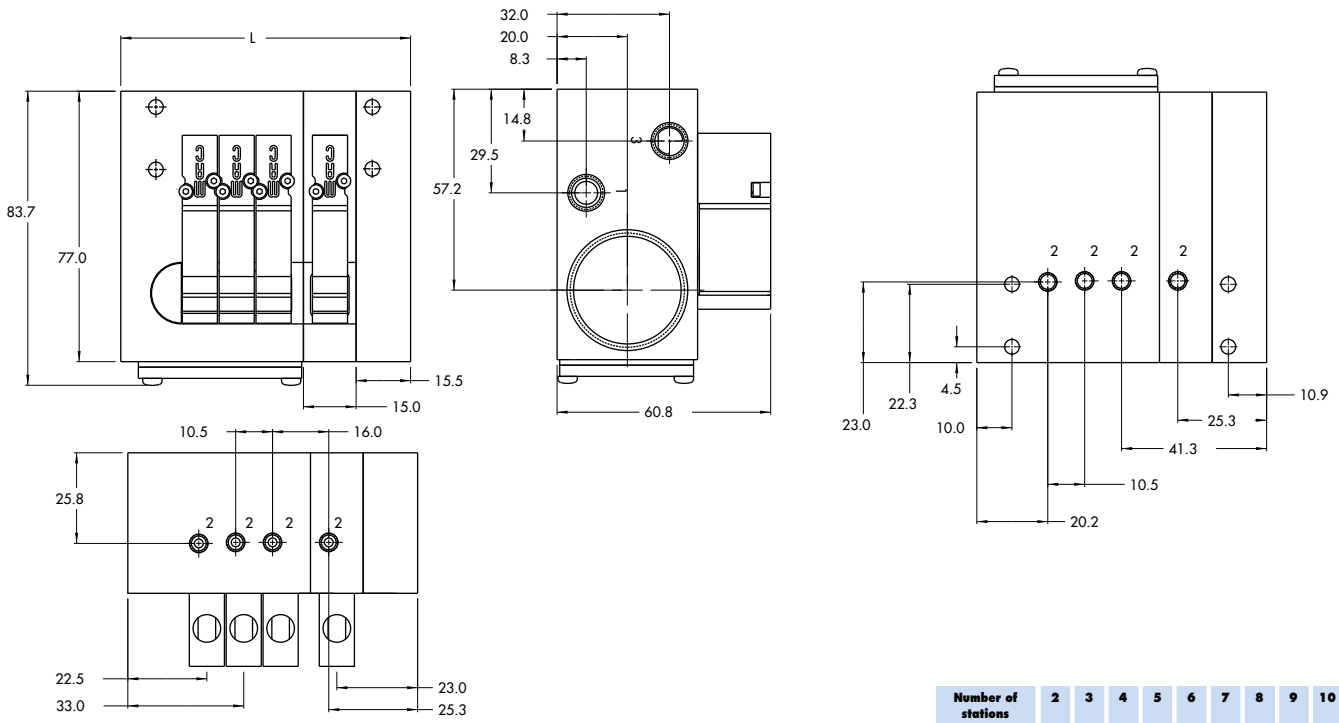

Number of stations	2	3	4	5	6	7	8	9	10
DIM. L	57.0	67.5	78.0	88.5	99.0	109.5	120.0	130.5	141.0

Function	Port size	Flow [Max]	Circuit bar mounting
3/2 NO-NC	M5 - #10-32	0.10C_v	add-on style plug-in with F. C.

OPERATIONAL BENEFITS

1. 10 mm valve, direct solenoid operated.
2. Balanced poppet, immune to variations of pressure.
3. Short stroke with high flow.
4. The patented solenoid develops high shifting forces.
5. Powerful return spring.
6. Flow is specifically adjusted on each valve.
7. Manual operator standard on all valves.



HOW TO ORDER

34B-xxx-GxxO-xxx

HOW TO ORDER VALVE FOR CIRCUIT BAR MOUNTING

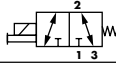
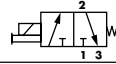
Port size (see base)	Universal valve	NC only valve
		
Valve less base	<input type="radio"/> 34B-100-GxxO-xxx	<input type="radio"/> 34B-NOO-GxxO-xxx

SOLENOID OPERATOR >

G **XX** O- **X** **XX***

XX Voltage	X Manual operator	XX Electrical connection
<input type="radio"/> DC 24VDC (1.8 W)	<input type="radio"/> 1 Non-locking	<input type="radio"/> DJ Plug-in
<input type="radio"/> DD 24VDC (2.5 W)		<input type="radio"/> DT Plug-in with light
<input type="radio"/> DF 24VDC (4.0 W)		<input type="radio"/> DE Plug-in with suppression diode
<input type="radio"/> xx Other Options		<input type="radio"/> DV Plug-in with light and suppression diode
		<input type="radio"/> xx Other Options

ECD034B-00xxx-AOxx

HOW TO ORDER CIRCUIT BAR WITH FLOW CONTROLS

Port size	Side cylinder ports (10.5 mm)	Bottom cylinder ports (10.5 mm)
M5	<input type="radio"/> ECD034B-005BD-AOxx	<input type="radio"/> ECD034B-006BD-AOxx
# 10-32	<input type="radio"/> ECD034B-005BB-AOxx	<input type="radio"/> ECD034B-006BB-AOxx

Number of stations (03=3 stations)

Note : clic for valves mounted on base at the factory, add - 9 to the model number.
 clic for multi-pin connector option (9, 15 or 25).
 add-a-unit stations may be added to above bars. Click here for model numbers.

**TECHNICAL
DATA**

Fluid :	Compressed air, vacuum, inert gases
Pressure range :	Vacuum to 120 PSI
Lubrication :	Not required, if used select a medium aniline point lubricant (between 180°F and 210°F)
Filtration :	40 µ
Temperature range :	0°F to 120°F (-18°C to +50°C)
Orifice :	1.8 mm
Flow (at 6 bar, ΔP=1bar) :	4 W : 0.10C _v , 2.5 W : 0.09C _v , 1.8 W : 0.07C _v
Coil :	General purpose class A, continuous duty, encapsulated
Voltage range :	-15% to +10% of nominal voltage
Power :	4 W - 2.5 W - 1.8 W
Response times :	Energize : 4 ms
(with 4 W coil)	De-energize : 1.5 ms

- Note : • Valve and coil are not interchangeable.
- Spare parts : • Seal between valve and bar : 16595. • Mounting screw (x2) : 35031. • Blanking plate : M-34005.
• Base wire Plug-in protector : 24180.
- Options : • Isolation of inlet and/or exhaust. • BSPP Threads.

DIMENSIONS

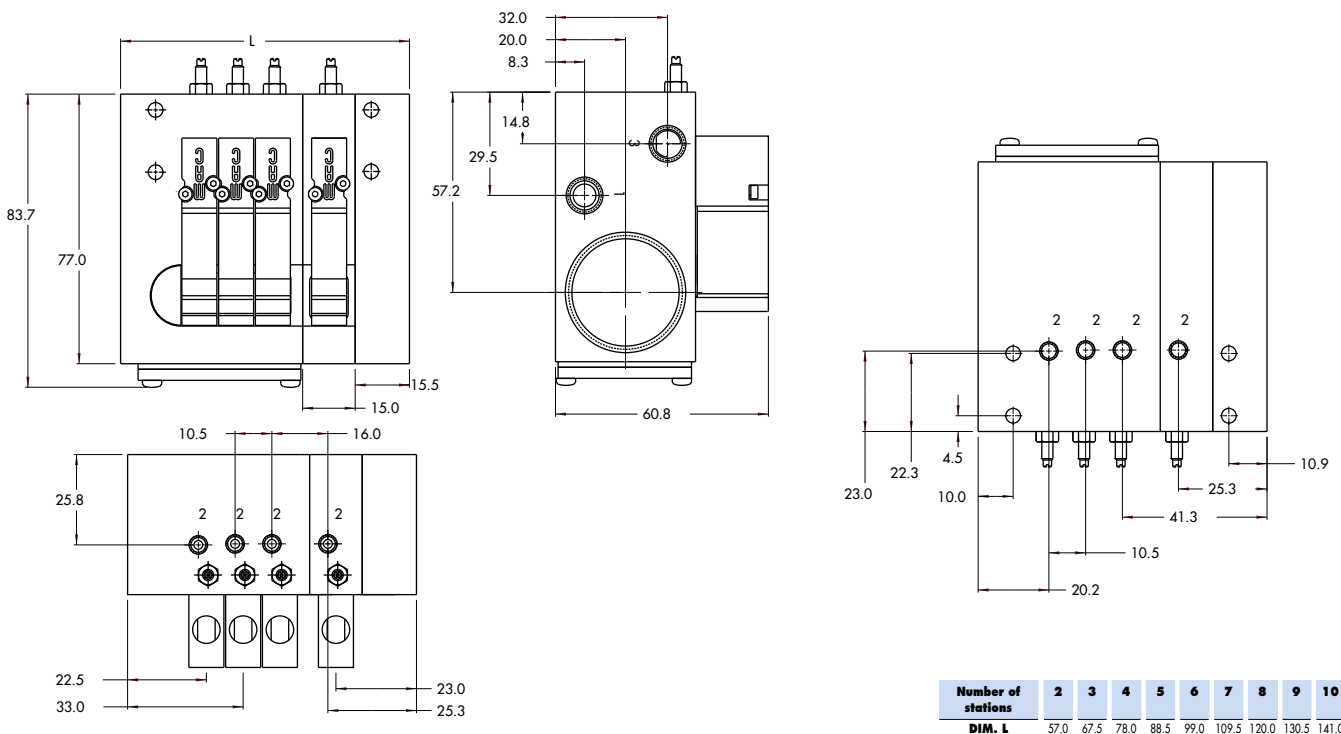

Function	Port size	Flow [Max]	Circuit bar mounting
3/2 NO-NC	M5 - #10-32	0.10C_v	add-on style plug-in with Pr. Reg.

OPERATIONAL BENEFITS

1. 10 mm valve, direct solenoid operated.
2. Balanced poppet, immune to variations of pressure.
3. Short stroke with high flow.
4. The patented solenoid develops high shifting forces.
5. Powerful return spring.
6. Flow is specifically adjusted on each valve.
7. Manual operator standard on all valves.



HOW TO ORDER

34B-xxx-GxxO-xxx

HOW TO ORDER VALVE FOR CIRCUIT BAR MOUNTING

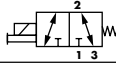
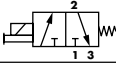
Port size (see base)	Universal valve	NC only valve
		
Valve less base	<input type="radio"/> 34B-100-GxxO-xxx	<input type="radio"/> 34B-NOO-GxxO-xxx

SOLENOID OPERATOR >

G **XX** O - **X** **XX** *

XX Voltage	X Manual operator	XX Electrical connection
<input type="radio"/> DC 24VDC (1.8 W)	<input type="radio"/> 1 Non-locking	<input type="radio"/> DJ Plug-in
<input type="radio"/> DD 24VDC (2.5 W)		<input type="radio"/> DT Plug-in with light
<input type="radio"/> DF 24VDC (4.0 W)		<input type="radio"/> DE Plug-in with suppression diode
<input type="radio"/> xx Other Options		<input type="radio"/> DV Plug-in with light and suppression diode
		<input type="radio"/> xx Other Options

ECD034B-00xxx-AOxx

HOW TO ORDER CIRCUIT BAR FOR PRESSURE REGULATORS ** (to be ordered separately)

Port size	Bottom cylinder ports (10.5 mm)	Side cylinder ports (10.5 mm)
M5	<input type="radio"/> ECD034B-004BD-AOxx	<input type="radio"/> ECD034B-003BD-AOxx
# 10-32	<input type="radio"/> ECD034B-004BB-AOxx	<input type="radio"/> ECD034B-003BB-AOxx

Number of stations (03=3 stations)

Note : clic for valves mounted on base at the factory, add - 9 to the model number.
 clic for multi-pin connector option (9, 15 or 25).
 add-a-unit stations may be added to above bars. Clic here for model numbers.

** Pressure Regulators :

PR44A-AOxx

- Y=A (no gage port)
- Y=B (with gage port)
- X=A (0 to 100 PSI)
- X=B (0 to 60 PSI)
- X=C (0 to 40 PSI)
- X=D (0 to 15 PSI)

**TECHNICAL
DATA**

Fluid :	Compressed air, vacuum, inert gases
Pressure range :	Vacuum to 120 PSI
Lubrication :	Not required, if used select a medium aniline point lubricant (between 180°F and 210°F)
Filtration :	40 µ
Temperature range :	0°F to 120°F (-18°C to +50°C)
Orifice :	1.8 mm
Flow (at 6 bar, ΔP=1bar) :	4 W : 0.10C _v , 2.5 W : 0.09C _v , 1.8 W : 0.07C _v
Coil :	General purpose class A, continuous duty, encapsulated
Voltage range :	-15% to +10% of nominal voltage
Power :	4 W - 2.5 W - 1.8 W
Response times :	Energize : 4 ms
(with 4 W coil)	De-energize : 1.5 ms

- Note : • Valve and coil are not interchangeable.
- Spare parts : • Seal between valve and bar : 16595. • Mounting screw (x2) : 35031. • Blanking plate : M-34005.
• Base wire Plug-in protector : 24180. • Blanking plate for regulator : N-44003.
- Options : • Isolation of inlet and/or exhaust. • BSPP Threads.

DIMENSIONS

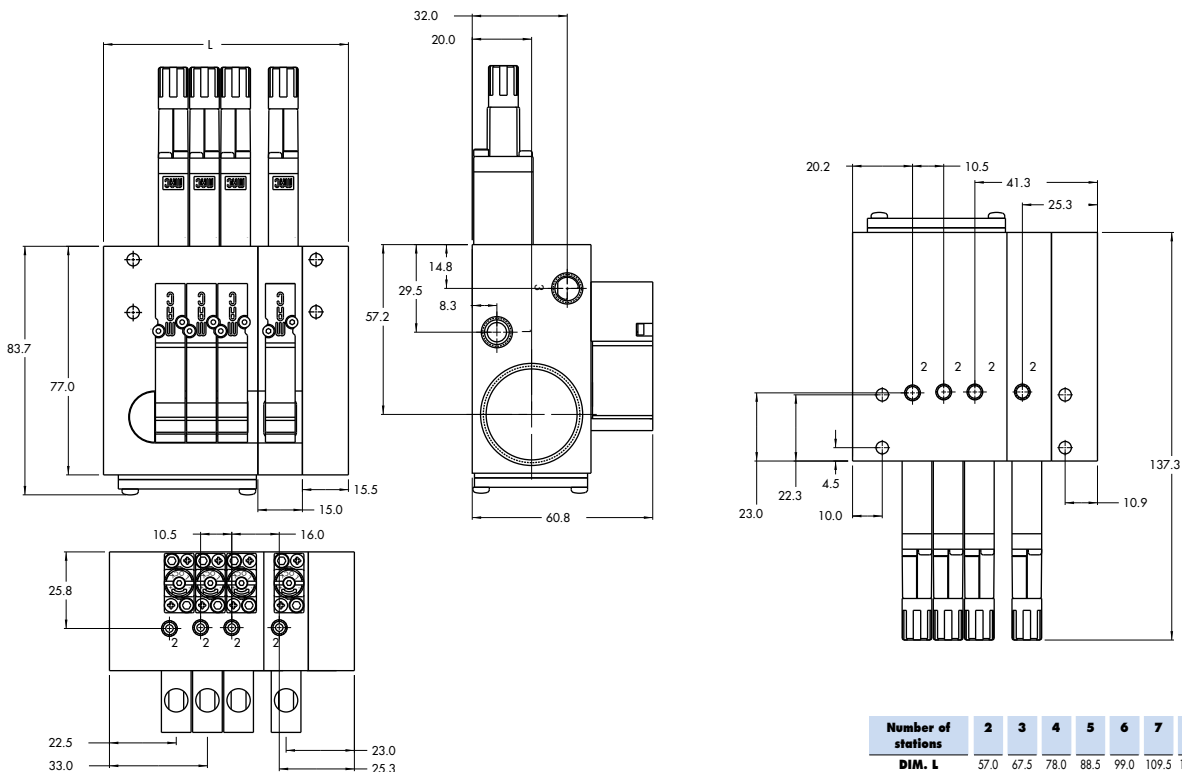

Function	Port size	Flow [Max]	Circuit bar mounting
3/2 NO-NC	M5 - #10-32	0.09C_v	add-on style plug-in with Pr. Reg. and F. C.

OPERATIONAL BENEFITS

1. 10 mm valve, direct solenoid operated.
2. Balanced poppet, immune to variations of pressure.
3. Short stroke with high flow.
4. The patented solenoid develops high shifting forces.
5. Powerful return spring.
6. Flow is specifically adjusted on each valve.
7. Manual operator standard on all valves.

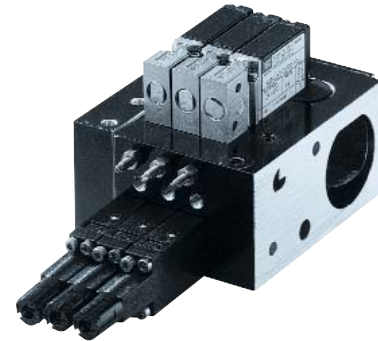

HOW TO ORDER

34B-xxx-GxxO-xxx

HOW TO ORDER VALVE FOR CIRCUIT BAR MOUNTING

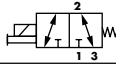
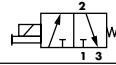
Port size (see base)	Universal valve	NC only valve
		
Valve less base	<input type="radio"/> 34B-100-GxxO-xxx	<input type="radio"/> 34B-NOO-GxxO-xxx

SOLENOID OPERATOR >

G XX O - X XX*

XX Voltage	X Manual operator	XX Electrical connection
<input type="radio"/> DC 24VDC (1.8 W)	<input type="radio"/> 1 Non-locking	<input type="radio"/> DJ Plug-in
<input type="radio"/> DD 24VDC (2.5 W)		<input type="radio"/> DT Plug-in with light
<input type="radio"/> DF 24VDC (4.0 W)		<input type="radio"/> DE Plug-in with suppression diode
<input type="radio"/> xx Other Options		<input type="radio"/> DV Plug-in with light and suppression diode
		<input type="radio"/> xx Other Options

ECD034B-00xxx-AOxx

HOW TO ORDER CIRCUIT BAR WITH FLOW CONTROLS AND PRESSURE REGULATORS ** (pressure regulators to be ordered separately)

Port size	Bottom cylinder ports (10.5 mm)	Side cylinder ports (10.5 mm)
M5	<input type="radio"/> ECD034B-007BD-AOxx	<input type="radio"/> ECD034B-008BD-AOxx
# 10-32	<input type="radio"/> ECD034B-007BB-AOxx	<input type="radio"/> ECD034B-008BB-AOxx

Number of stations (03=3 stations)

Note : clic for valves mounted on base at the factory, add - 9 to the model number.
 clic for multi-pin connector option (9, 15 or 25).
 add-a-unit stations may be added to above bars. Clic here for model numbers.

** Pressure Regulators :

PR44A-AOxx

- Y=A (no gage port)
- Y=B (with gage port)
- X=A (0 to 100 PSI)
- X=B (0 to 60 PSI)
- X=C (0 to 40 PSI)
- X=D (0 to 15 PSI)

**TECHNICAL
D A T A**

Fluid :	Compressed air, vacuum, inert gases
Pressure range :	Vacuum to 120 PSI
Lubrication :	Not required, if used select a medium aniline point lubricant (between 180°F and 210°F)
Filtration :	40 µ
Temperature range :	0°F to 120°F (-18°C to +50°C)
Orifice :	1.8 mm
Flow (at 6 bar, ΔP=1bar) :	4 W : 0.10C _v , 2.5 W : 0.09C _v , 1.8 W : 0.07C _v
Coil :	General purpose class A, continuous duty, encapsulated
Voltage range :	-15% to +10% of nominal voltage
Power :	4 W - 2.5 W - 1.8 W
Response times :	Energize : 4 ms
(with 4 W coil)	De-energize : 1.5 ms

- Note : • Valve and coil are not interchangeable.
- Spare parts : • Seal between valve and bar : 16595. • Mounting screw (x2) : 35031. • Blanking plate : M-34005.
• Blanking plate for regulator : N-44003. • Base wire Plug-in protector : 24180.
- Options : • Isolation of inlet and/or exhaust. • BSPP Threads.

DIMENSIONS

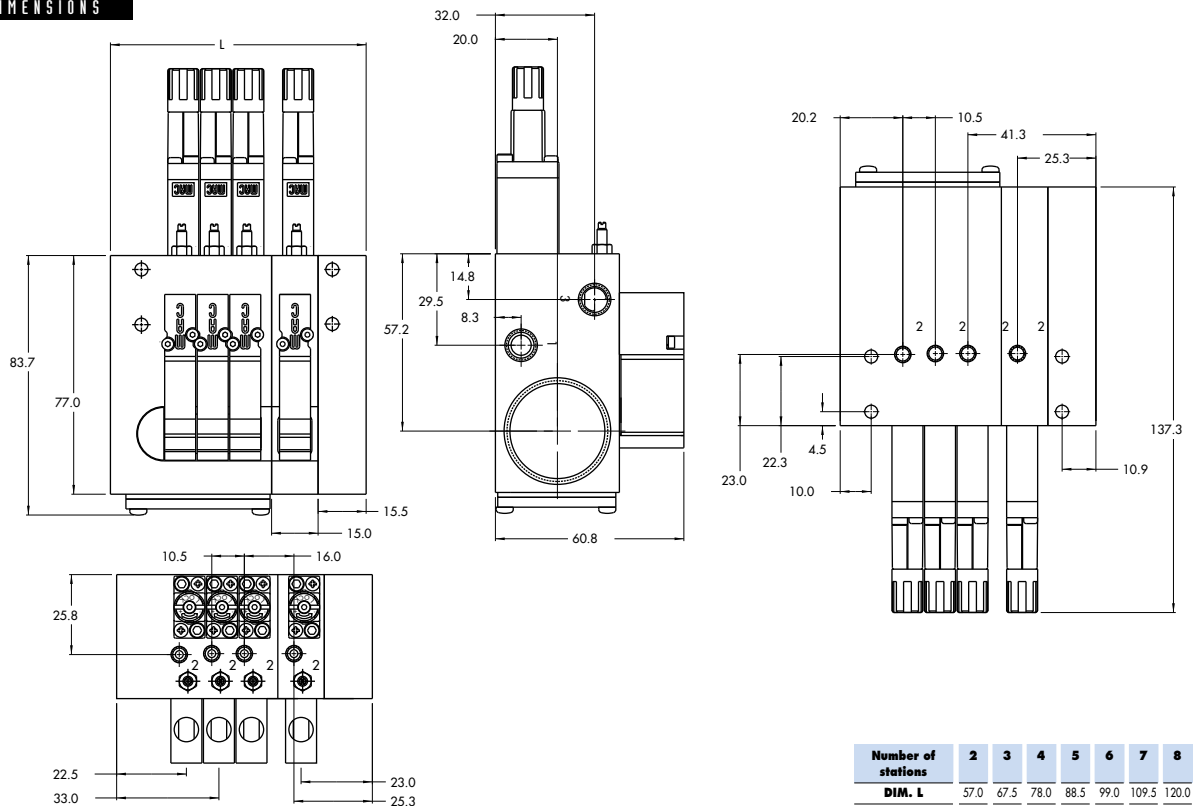

Function	Port size	Flow [Max]	Circuit bar mounting
3/2 NO-NC	M5 - #10-32	0.10C_v	plug-in add-a-unit stations

OPERATIONAL BENEFITS

1. 10 mm valve, direct solenoid operated.
2. Balanced poppet, immune to variations of pressure.
3. Short stroke with high flow.
4. The patented solenoid develops high shifting forces.
5. Powerful return spring.
6. Flow is specifically adjusted on each valve.
7. Manual operator standard on all valves.



HOW TO ORDER

34B-xxx-GxxO-xxx

HOW TO ORDER VALVE FOR CIRCUIT BAR MOUNTING

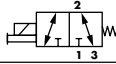
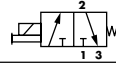
Port size (see base)	Universal valve	NC only valve
		
Valve less base	<input type="radio"/> 34B-100-GxxO-xxx	<input type="radio"/> 34B-NOO-GxxO-xxx

SOLENOID OPERATOR >

G XX O- X XX*

XX Voltage	X Manual operator	XX Electrical connection
<input type="radio"/> DC 24VDC (1.8 W)	<input type="radio"/> 1 Non-locking	<input type="radio"/> DJ Plug-in
<input type="radio"/> DD 24VDC (2.5 W)		<input type="radio"/> DT Plug-in with light
<input type="radio"/> DF 24VDC (4.0 W)		<input type="radio"/> DE Plug-in with suppression diode
<input type="radio"/> xx Other Options		<input type="radio"/> DV Plug-in with light and suppression diode
		<input type="radio"/> xx Other Options

ECD034B-00xxx-AOxx

HOW TO ORDER CIRCUIT BAR

Port size	Side cylinder ports	Bottom cylinder ports
M5	<input type="radio"/> ECD034B-001CD-AOxx	<input type="radio"/> ECD034B-002CD-AOxx
# 10-32	<input type="radio"/> ECD034B-001CB-AOxx	<input type="radio"/> ECD034B-002CB-AOxx

Number of stations (03=3 stations) - Maximum length is 4 stations
 Note : clic for valves mounted on base at the factory, add - 9 to the model number.
 when add-a-unit stations are added to bars with a multi-pin connector,
 MOD. SD03 should be included with add-a-unit model number.

**TECHNICAL
DATA**

Fluid :	Compressed air, vacuum, inert gases
Pressure range :	Vacuum to 120 PSI
Lubrication :	Not required, if used select a medium aniline point lubricant (between 180°F and 210°F)
Filtration :	40 µ
Temperature range :	0°F to 120°F (-18°C to +50°C)
Orifice :	1.8 mm
Flow (at 6 bar, ΔP=1bar) :	4 W : 0.10C _v , 2.5 W : 0.09C _v , 1.8 W : 0.07C _v
Coil :	General purpose class A, continuous duty, encapsulated
Voltage range :	-15% to +10% of nominal voltage
Power :	4 W - 2.5 W - 1.8 W
Response times :	Energize : 4 ms
(with 4 W coil)	De-energize : 1.5 ms

- Note : • Valve and coil are not interchangeable.
- Spare parts : • Seal between valve and bar : 16595. • Mounting screw (x2) : 35031. • Blanking plate : M-34005.
• Base wire Plug-in protector : 24180.
- Options : • Isolation of inlet and/or exhaust. • BSPP Threads.

DIMENSIONS

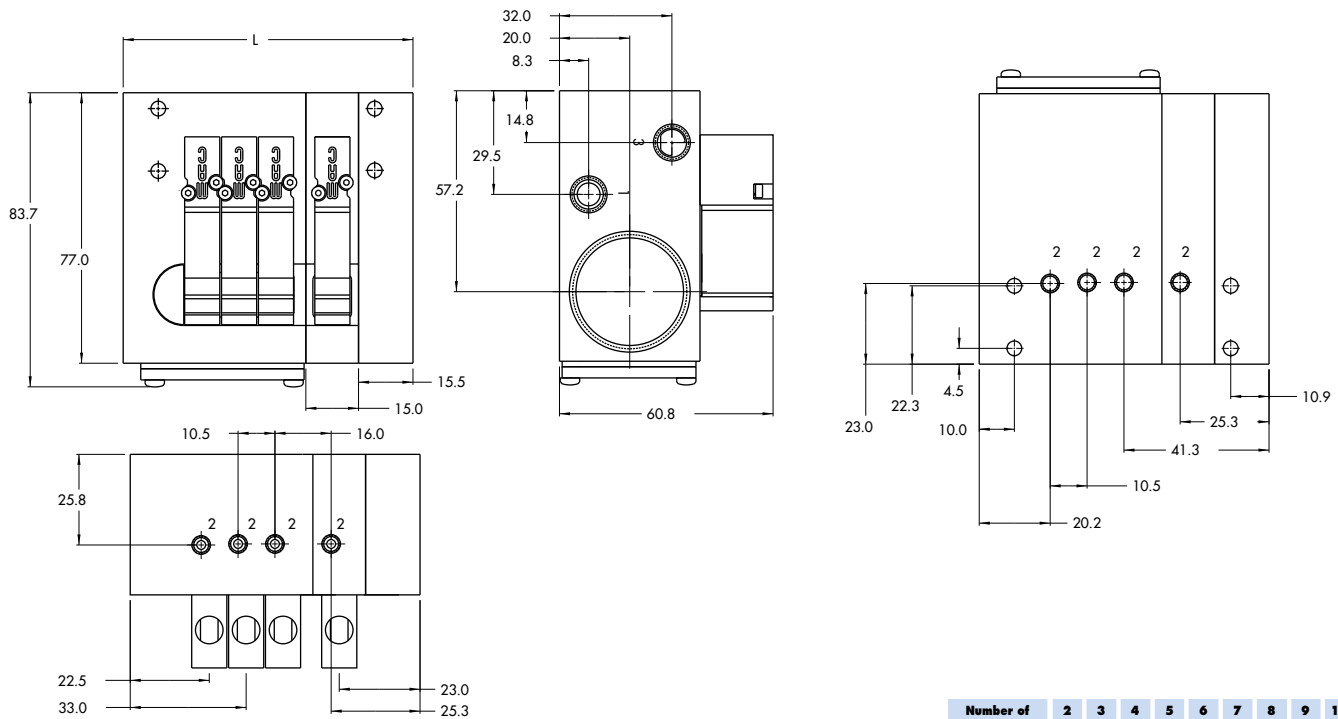

Function	Port size	Flow (Max)	Circuit bar mounting
3/2 NO-NC	M5 - #10-32	0.10C_v	plug-in add-a-unit stations with F. C.

OPERATIONAL BENEFITS

1. 10 mm valve, direct solenoid operated.
2. Balanced poppet, immune to variations of pressure.
3. Short stroke with high flow.
4. The patented solenoid develops high shifting forces.
5. Powerful return spring.
6. Flow is specifically adjusted on each valve.
7. Manual operator standard on all valves.



HOW TO ORDER

34B-xxx-GxxO-xxx

HOW TO ORDER VALVE FOR CIRCUIT BAR MOUNTING

Port size (see base)	Universal valve	NC only valve
Valve less base	<input type="radio"/> 34B-LOO-GxxO-xxx	<input type="radio"/> 34B-NOO-GxxO-xxx

SOLENOID OPERATOR >

G **XX** O- **X XX**

XX Voltage	X Manual operator	XX Electrical connection
<input type="radio"/> DC 24VDC (1.8 W)	<input type="radio"/> 1 Non-locking	<input type="radio"/> DJ Plug-in
<input type="radio"/> DD 24VDC (2.5 W)		<input type="radio"/> DT Plug-in with light
<input type="radio"/> DF 24VDC (4.0 W)		<input type="radio"/> DE Plug-in with suppression diode
<input type="radio"/> xx Other Options		<input type="radio"/> DV Plug-in with light and suppression diode
		<input type="radio"/> xx Other Options

ECD034B-00xxx-AOxx

HOW TO ORDER CIRCUIT BAR WITH FLOW CONTROLS

Port size	Side cylinder ports	Bottom cylinder ports
M5	<input type="radio"/> ECD034B-005CD-AOxx	<input type="radio"/> ECD034B-006CD-AOxx
# 10-32	<input type="radio"/> ECD034B-005CB-AOxx	<input type="radio"/> ECD034B-006CB-AOxx

Number of stations (03=3 stations) - Maximum length is 4 stations
 Note : clic for valves mounted on base at the factory, add - 9 to the model number.
 when add-a-unit stations are added to bars with a multi-pin connector,
 MOD. SD03 should be included with add-a-unit model number.

**TECHNICAL
DATA**

Fluid :	Compressed air, vacuum, inert gases
Pressure range :	Vacuum to 120 PSI
Lubrication :	Not required, if used select a medium aniline point lubricant (between 180°F and 210°F)
Filtration :	40 µ
Temperature range :	0°F to 120°F (-18°C to +50°C)
Orifice :	1.8 mm
Flow (at 6 bar, ΔP=1bar) :	4 W : 0.10C _v , 2.5 W : 0.09C _v , 1.8 W : 0.07C _v
Coil :	General purpose class A, continuous duty, encapsulated
Voltage range :	-15% to +10% of nominal voltage
Power :	4 W - 2.5 W - 1.8 W
Response times :	Energize : 4 ms
(with 4 W coil)	De-energize : 1.5 ms

- Note :
 - Valve and coil are not interchangeable.
- Spare parts :
 - Seal between valve and bar : 16595. • Mounting screw (x2) : 35031. • Blanking plate : M-34005.
 - Base wire Plug-in protector : 24180.
- Options :
 - Isolation of inlet and/or exhaust. • BSPP Threads.

DIMENSIONS

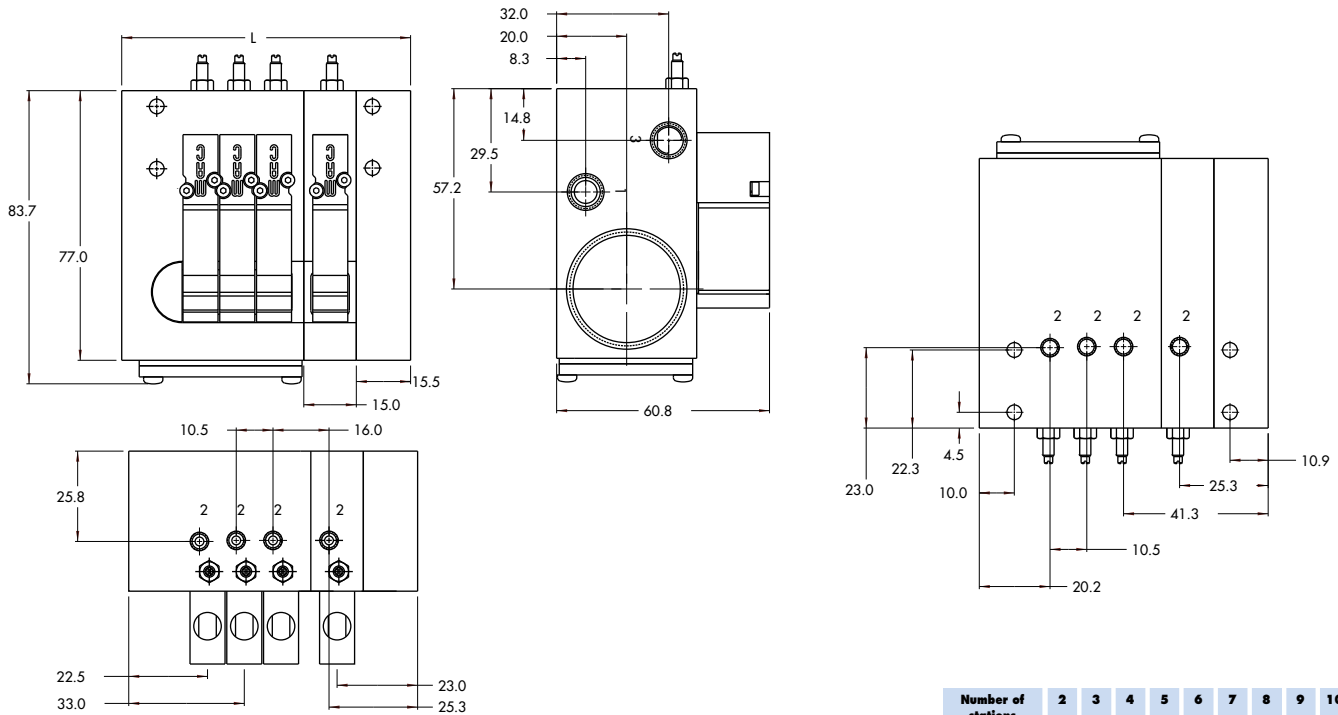

Function	Port size	Flow (Max)	Circuit bar mounting
3/2 NO-NC	M5 - #10-32	0.10C_v	plug-in add-a-unit stations with Pr. Reg.

OPERATIONAL BENEFITS

1. 10 mm valve, direct solenoid operated.
2. Balanced poppet, immune to variations of pressure.
3. Short stroke with high flow.
4. The patented solenoid develops high shifting forces.
5. Powerful return spring.
6. Flow is specifically adjusted on each valve.
7. Manual operator standard on all valves.



HOW TO ORDER

34B-xxx-GxxO-xxx

HOW TO ORDER VALVE FOR CIRCUIT BAR MOUNTING

Port size (see base)	Universal valve	NC only valve
Valve less base	<input type="radio"/> 34B-100-GxxO-xxx	<input type="radio"/> 34B-NOO-GxxO-xxx

SOLENOID OPERATOR >

G **XX** O- **X** **XX** *

XX Voltage	X Manual operator	XX Electrical connection
<input type="radio"/> DC 24VDC (1.8 W)	<input type="radio"/> 1 Non-locking	<input type="radio"/> DJ Plug-in
<input type="radio"/> DD 24VDC (2.5 W)		<input type="radio"/> DT Plug-in with light
<input type="radio"/> DF 24VDC (4.0 W)		<input type="radio"/> DE Plug-in with suppression diode
<input type="radio"/> xx Other Options		<input type="radio"/> DV Plug-in with light and suppression diode
		<input type="radio"/> xx Other Options

ECD034B-00xxx-AOxx

HOW TO ORDER CIRCUIT BAR FOR PRESSURE REGULATORS ** (to be ordered separately)

Port size	Side cylinder ports	Bottom cylinder ports
M5	<input type="radio"/> ECD034B-003CD-AOxx	<input type="radio"/> ECD034B-004CD-AOxx
# 10-32	<input type="radio"/> ECD034B-003CB-AOxx	<input type="radio"/> ECD034B-004CB-AOxx

Number of stations (03=3 stations) - Maximum length is 4 stations
 Note: clic for valves mounted on base at the factory, add - 9 to the model number.
 when add-a-unit stations are added to bars with a multi-pin connector,
 MOD. SD03 should be included with add-a-unit model number.

** Regulator ordered separately-see below

PR44A-AOxx

- Y=A (no gage port)
- Y=B (with gage port)
- X=A (0 to 100 PSI)
- X=B (0 to 60 PSI)
- X=C (0 to 40 PSI)
- X=D (0 to 1.5 PSI)

**TECHNICAL
DATA**

Fluid :	Compressed air, vacuum, inert gases
Pressure range :	Vacuum to 120 PSI
Lubrication :	Not required, if used select a medium aniline point lubricant (between 180°F and 210°F)
Filtration :	40 µ
Temperature range :	0°F to 120°F (-18°C to +50°C)
Orifice :	1.8 mm
Flow (at 6 bar, ΔP=1bar) :	4 W : 0.10C _v , 2.5 W : 0.09C _v , 1.8 W : 0.07C _v
Coil :	General purpose class A, continuous duty, encapsulated
Voltage range :	-15% to +10% of nominal voltage
Power :	4 W - 2.5 W - 1.8 W
Response times :	Energize : 4 ms
(with 4 W coil)	De-energize : 1.5 ms

- Note : • Valve and coil are not interchangeable.
- Spare parts : • Seal between valve and bar : 16595. • Mounting screw (x2) : 35031. • Blanking plate : M-34005.
• Base wire Plug-in protector : 24180. • Blanking plate for regulator : N-44003.
- Options : • Isolation of inlet and/or exhaust. • BSPP Threads.

DIMENSIONS

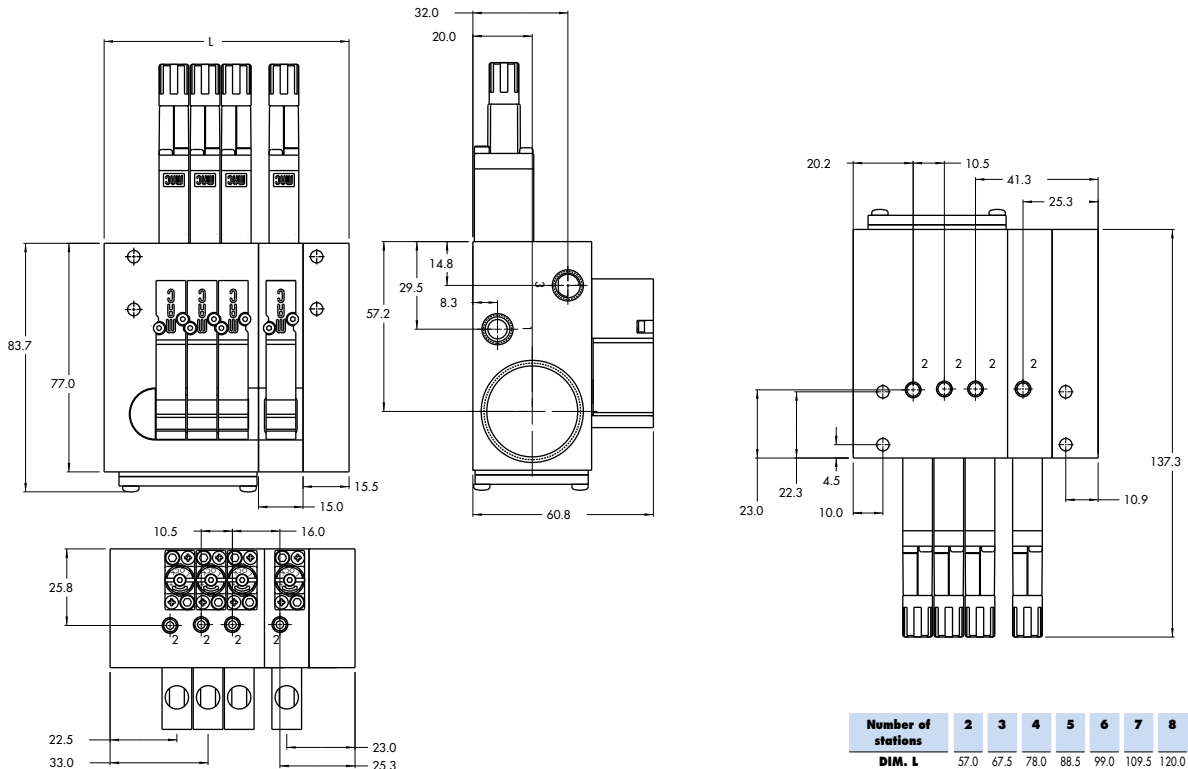

Function	Port size	Flow (Max)	Circuit bar mounting
3/2 NO-NC	M5 - #10-32	0.10C_v	plug-in add-a-unit stations with F. C. and Pr. Reg.

OPERATIONAL BENEFITS

1. 10 mm valve, direct solenoid operated.
2. Balanced poppet, immune to variations of pressure.
3. Short stroke with high flow.
4. The patented solenoid develops high shifting forces.
5. Powerful return spring.
6. Flow is specifically adjusted on each valve.
7. Manual operator standard on all valves.

Reset

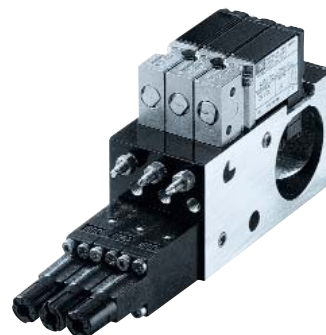

HOW TO ORDER

34B-xxx-GxxO-xxx

HOW TO ORDER VALVE FOR CIRCUIT BAR MOUNTING

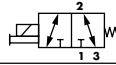
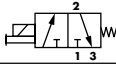
Port size (see base)	Universal valve	NC only valve
		
Valve less base	<input type="radio"/> 34B-100-GxxO-xxx	<input type="radio"/> 34B-NOO-GxxO-xxx

SOLENOID OPERATOR >

G XX O- X XX*

XX Voltage	X Manual operator	XX Electrical connection
<input type="radio"/> DC 24VDC (1.8 W)	<input type="radio"/> 1 Non-locking	<input type="radio"/> DJ Plug-in
<input type="radio"/> DD 24VDC (2.5 W)		<input type="radio"/> DT Plug-in with light
<input type="radio"/> DF 24VDC (4.0 W)		<input type="radio"/> DE Plug-in with suppression diode
<input type="radio"/> xx Other Options		<input type="radio"/> DV Plug-in with light and suppression diode
		<input type="radio"/> xx Other Options

ECD034B-00xxx-AOxx

HOW TO ORDER CIRCUIT BAR WITH FLOW CONTROLS AND PRESSURE REGULATORS ** (pressure regulators to be ordered separately)

Port size	Side cylinder ports	Bottom cylinder ports
M5	<input type="radio"/> ECD034B-008CD-AOxx	<input type="radio"/> ECD034B-007CD-AOxx
# 10-32	<input type="radio"/> ECD034B-008CB-AOxx	<input type="radio"/> ECD034B-007CB-AOxx

Number of stations (03=3 stations) - Maximum length is 4 stations
 Note: clic for valves mounted on base at the factory, add - 9 to the model number.
 when add-a-unit stations are added to bars with a multi-pin connector,
 MOD. SD03 should be included with add-a-unit model number.

** Regulator ordered separately-see below

PR44A-AOxx

- Y=A (no gage port)
- Y=B (with gage port)
- X=A (0 to 100 PSI)
- X=B (0 to 60 PSI)
- X=C (0 to 40 PSI)
- X=D (0 to 15 PSI)

**TECHNICAL
D A T A**

Fluid :	Compressed air, vacuum, inert gases
Pressure range :	Vacuum to 120 PSI
Lubrication :	Not required, if used select a medium aniline point lubricant (between 180°F and 210°F)
Filtration :	40 µ
Temperature range :	0°F to 120°F (-18°C to +50°C)
Orifice :	1.8 mm
Flow (at 6 bar, ΔP=1bar) :	4 W : 0.10C _v , 2.5 W : 0.09C _v , 1.8 W : 0.07C _v
Coil :	General purpose class A, continuous duty, encapsulated
Voltage range :	-15% to +10% of nominal voltage
Power :	4 W - 2.5 W - 1.8 W
Response times :	Energize : 4 ms
(with 4 W coil)	De-energize : 1.5 ms

- Note : • Valve and coil are not interchangeable.
- Spare parts : • Seal between valve and bar : 16595. • Mounting screw (x2) : 35031. • Blanking plate : M-34005.
• Blanking plate for regulator : N-44003. • Base wire Plug-in protector : 24180.
- Options : • Isolation of inlet and/or exhaust. • BSPP Threads.

DIMENSIONS

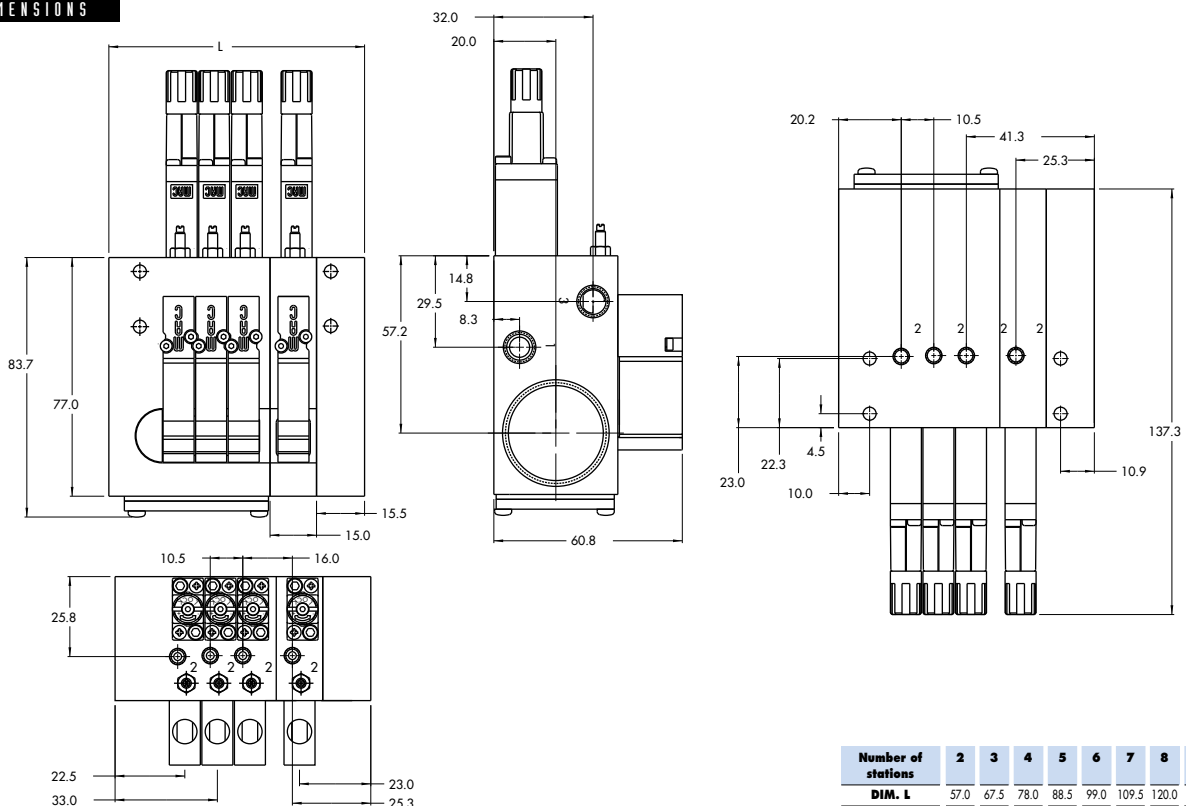

Function	Port size	Flow [Max]	Circuit bar mounting
3/2 NO-NC	M5 - #10-32, 4mm tube receptacle	0.11C_v	plug-in with pre-wired connector

OPERATIONAL BENEFITS

1. 10 mm valve, direct solenoid operated.
2. Balanced poppet, immune to variations of pressure.
3. Short stroke with high flow.
4. The patented solenoid develops high shifting forces.
5. Powerful return spring.
6. Flow is specifically adjusted on each valve.
7. Manual operator standard on all valves.



HOW TO ORDER

34B-xxx-GxxO-xxx

HOW TO ORDER VALVE FOR CIRCUIT BAR MOUNTING

Port size (see base)	Universal valve	NC only valve
Valve less base	<input type="radio"/> 34B-100-GxxO-xxx	<input type="radio"/> 34B-NOO-GxxO-xxx

SOLENOID OPERATOR

G XX O - X XX*

XX Voltage	X Manual operator	XX Electrical connection
<input type="radio"/> DC 24VDC (1.8 W)	<input type="radio"/> 1 Non-locking	<input type="radio"/> DJ Plug-in
<input type="radio"/> DD 24VDC (2.5 W)		<input type="radio"/> DT Plug-in with light
<input type="radio"/> DF 24VDC (4.0 W)		<input type="radio"/> DE Plug-in with suppression diode
<input type="radio"/> xx Other Options		<input type="radio"/> DV Plug-in with light and suppression diode
		<input type="radio"/> xx Other Options

HOW TO ORDER CIRCUIT BAR

ECF34B-00xxx-xxxx

Port size	Side cylinder ports (10.5 mm)	Bottom cylinder ports (10.5 mm)
M5	<input type="radio"/> ECF34B-00ADA-zzxx	<input type="radio"/> ECF34B-00BDA-zzxx
# 10-32	<input type="radio"/> ECF34B-00ABA-zzxx	<input type="radio"/> ECF34B-00BBA-zzxx
4 mm tube receptacle	<input type="radio"/> ECF34B-00AEA-zzxx	-----

Number of stations (03=3 stations)
 Note: clic for valves mounted on base at the factory, add - 9 to the model number.

L=Left Side; R=Right Side

ZZ	Connector	ZZ	Connector
<input type="radio"/> LA	9 Pin Sub D*	<input type="radio"/> RA	9 Pin Sub D*
<input type="radio"/> LB	15 Pin Sub D*	<input type="radio"/> RB	15 Pin Sub D*
<input type="radio"/> LC	25 Pin Sub D*	<input type="radio"/> RC	25 Pin Sub D*
<input type="radio"/> LD	10 Pin Ribbon Cable**	<input type="radio"/> RD	10 Pin Ribbon Cable**
<input type="radio"/> LE	16 Pin Ribbon Cable**	<input type="radio"/> RE	16 Pin Ribbon Cable**
<input type="radio"/> LF	20 Pin Ribbon Cable**	<input type="radio"/> RF	20 Pin Ribbon Cable**
<input type="radio"/> LG	26 Pin Ribbon Cable**	<input type="radio"/> RG	26 Pin Ribbon Cable**
<input type="radio"/> LH	3/8" NPSM Conduit Port Standard Base Wires	<input type="radio"/> RH	3/8" NPSM Conduit Port Standard Base Wires

* MIL. Spec; MIL-C-24308
 ** MIL. Spec; MIL-C-83503
 Note: Left and right end is determined by facing conduit passage.

**TECHNICAL
DATA**

Fluid :	Compressed air, vacuum, inert gases
Pressure range :	Vacuum to 120 PSI
Lubrication :	Not required, if used select a medium aniline point lubricant (between 180°F and 210°F)
Filtration :	40 µ
Temperature range :	0°F to 120°F (-18°C to +50°C)
Orifice :	1.8 mm
Flow (at 6 bar, ΔP=1bar) :	4 W : 0.10C _v , 2.5 W : 0.09C _v , 1.8 W : 0.07C _v
Coil :	General purpose class A, continuous duty, encapsulated
Voltage range :	-15% to +10% of nominal voltage
Power :	4 W - 2.5 W - 1.8 W
Response times :	Energize : 4 ms
(with 4 W coil)	De-energize : 1.5 ms

- Note : • Valve and coil are not interchangeable.
- Spare parts : • Seal between valve and bar : 16595. • Mounting screw (x2) : 35031. • Blanking plate : M-34005.
• Base wire Plug-in protector : 24180.
- Options : • Isolation of inlet and/or exhaust. • BSPP Threads.

DIMENSIONS

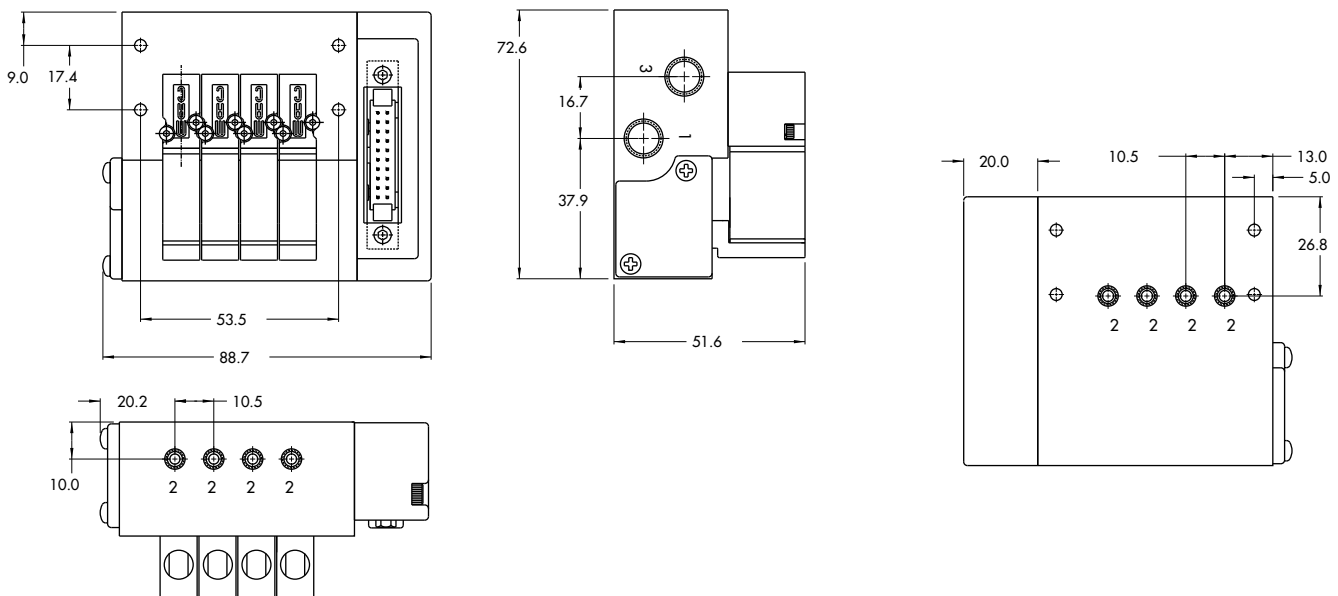

Function	Port size	Flow (Max)	Circuit bar mounting
3/2 NO-NC	M5 - #10-32, 4mm tube receptacle	0.11C_v	plug-in with F. C. and pre-wired connector

OPERATIONAL BENEFITS

1. 10 mm valve, direct solenoid operated.
2. Balanced poppet, immune to variations of pressure.
3. Short stroke with high flow.
4. The patented solenoid develops high shifting forces.
5. Powerful return spring.
6. Flow is specifically adjusted on each valve.
7. Manual operator standard on all valves.



HOW TO ORDER

34B-xxx-GxxO-xxx

HOW TO ORDER VALVE FOR CIRCUIT BAR MOUNTING

Port size (see base)	Universal valve	NC only valve
Valve less base	<input type="radio"/> 34B-LOO-GxxO-xxx	<input type="radio"/> 34B-NOO-GxxO-xxx

SOLENOID OPERATOR >

G XX O - X XX *

XX Voltage	X Manual operator	XX Electrical connection
<input type="radio"/> DC 24VDC (1.8 W)	<input type="radio"/> 1 Non-locking	<input type="radio"/> DJ Plug-in
<input type="radio"/> DD 24VDC (2.5 W)		<input type="radio"/> DT Plug-in with light
<input type="radio"/> DF 24VDC (4.0 W)		<input type="radio"/> DE Plug-in with suppression diode
<input type="radio"/> xx Other Options		<input type="radio"/> DV Plug-in with light and suppression diode
		<input type="radio"/> xx Other Options

HOW TO ORDER CIRCUIT BAR WITH FLOW CONTROLS

ECF34B-00xxx-xxxx

Port size	Side cylinder ports (10.5 mm)	Bottom cylinder ports (10.5 mm)
M5	<input type="radio"/> ECF34B-00CDA- zzxx	<input type="radio"/> ECF34B-00DDA- zzxx
# 10-32	<input type="radio"/> ECF34B-00CBA- zzxx	<input type="radio"/> ECF34B-00DBA- zzxx
4 mm tube receptacle	<input type="radio"/> ECF34B-00CEA- zzxx	-----

Number of stations (03=3 stations)
 Note: clic for valves mounted on base at the factory, add - 9 to the model number.

L=Left Side; R=Right Side

ZZ Connector	ZZ Connector
<input type="radio"/> LA 9 Pin Sub D*	<input type="radio"/> RA 9 Pin Sub D*
<input type="radio"/> LB 15 Pin Sub D*	<input type="radio"/> RB 15 Pin Sub D*
<input type="radio"/> LC 25 Pin Sub D*	<input type="radio"/> RC 25 Pin Sub D*
<input type="radio"/> LD 10 Pin Ribbon Cable**	<input type="radio"/> RD 10 Pin Ribbon Cable**
<input type="radio"/> LE 16 Pin Ribbon Cable**	<input type="radio"/> RE 16 Pin Ribbon Cable**
<input type="radio"/> LF 20 Pin Ribbon Cable**	<input type="radio"/> RF 20 Pin Ribbon Cable**
<input type="radio"/> LG 26 Pin Ribbon Cable**	<input type="radio"/> RG 26 Pin Ribbon Cable**
<input type="radio"/> LH 3/8" NPSM Conduit Port Standard Base Wires	<input type="radio"/> RH 3/8" NPSM Conduit Port Standard Base Wires

* MIL. Spec; MIL-C-24308
 ** MIL. Spec; MIL-C-83503
 Note: Left and right end is determined by facing conduit passage.

**T E C H N I C A L
D A T A**

Fluid :	Compressed air, vacuum, inert gases
Pressure range :	Vacuum to 120 PSI
Lubrication :	Not required, if used select a medium aniline point lubricant (between 180°F and 210°F)
Filtration :	40 µ
Temperature range :	0°F to 120°F (-18°C to +50°C)
Orifice :	1.8 mm
Flow (at 6 bar, ΔP=1bar) :	4 W : 0.11C _v , 2.5 W : 0.09C _v , 1.8 W : 0.06C _v
Coil :	General purpose class A, continuous duty, encapsulated
Voltage range :	-15% to +10% of nominal voltage
Power :	4 W - 2.5 W - 1.8 W
Response times :	Energize : 4 ms
(with 4 W coil)	De-energize : 1.5 ms

- Note :
 - Valve and coil are not interchangeable.
- Spare parts :
 - Seal between valve and bar : 16595. • Mounting screw (x2) : 35031. • Blanking plate : M-34005.
 - Base wire Plug-in protector : 24180.
- Options :
 - Isolation of inlet and/or exhaust. • BSPP Threads.

D I M E N S I O N S

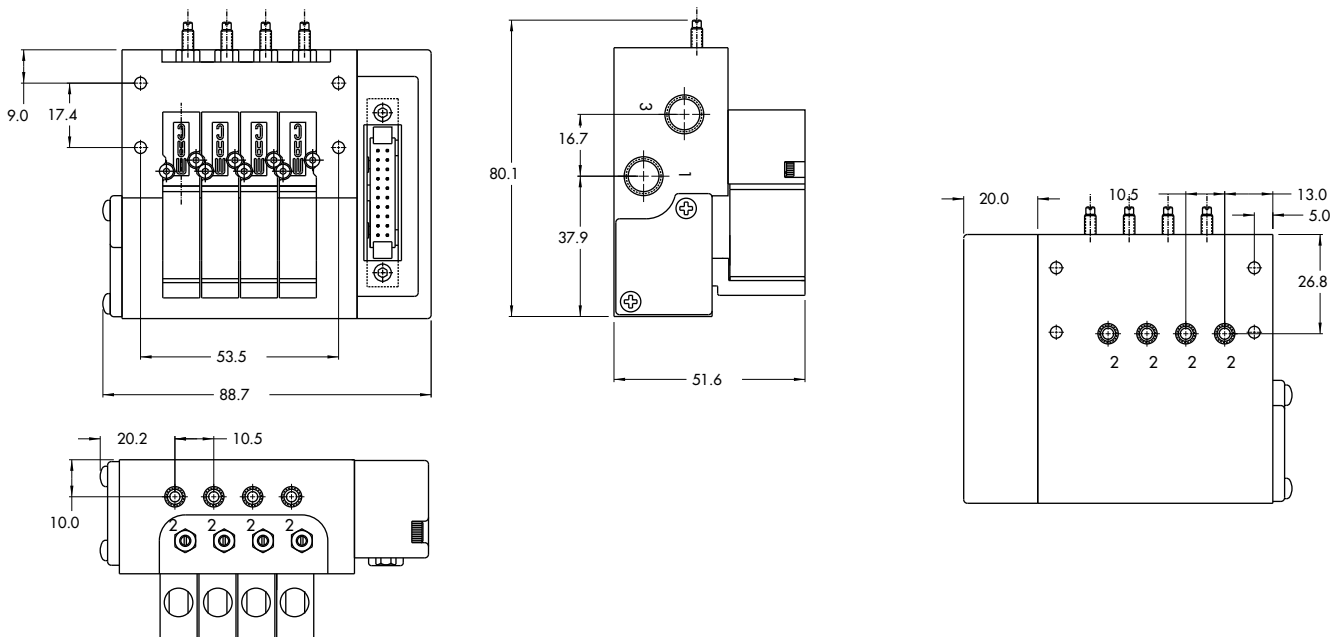

Function	Port size	Flow (Max)	Circuit bar mounting
3/2 NO-NC	M5 - #10-32	0.10C_v	plug-in with Pr. Reg. and pre-wired connector

OPERATIONAL BENEFITS

1. 10 mm valve, direct solenoid operated.
2. Balanced poppet, immune to variations of pressure.
3. Short stroke with high flow.
4. The patented solenoid develops high shifting forces.
5. Powerful return spring.
6. Flow is specifically adjusted on each valve.
7. Manual operator standard on all valves.

Reset

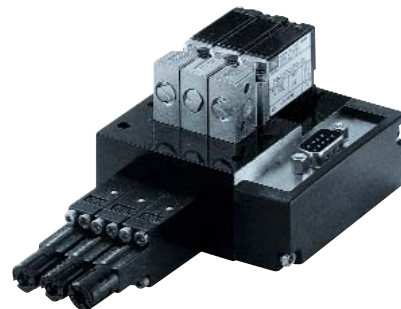

HOW TO ORDER

34B-xxx-GxxO-xxx

HOW TO ORDER VALVE FOR CIRCUIT BAR MOUNTING

Port size (see base)	Universal valve	NC only valve
Valve less base	<input type="radio"/> 34B-100-GxxO-xxx	<input type="radio"/> 34B-NOO-GxxO-xxx

SOLENOID OPERATOR

G XX O - X XX *

XX Voltage	X Manual operator	XX Electrical connection
<input type="radio"/> DC 24VDC (1.8 W)	<input type="radio"/> 1 Non-locking	<input type="radio"/> DJ Plug-in
<input type="radio"/> DD 24VDC (2.5 W)		<input type="radio"/> DT Plug-in with light
<input type="radio"/> DF 24VDC (4.0 W)		<input type="radio"/> DE Plug-in with suppression diode
<input type="radio"/> xx Other Options		<input type="radio"/> DV Plug-in with light and suppression diode
		<input type="radio"/> xx Other Options

HOW TO ORDER CIRCUIT BAR FOR PRESSURE REGULATORS ** (to be ordered separately)

ECF34B-00xxx-xxxx

Port size	Bottom cylinder ports (10.5 mm)
M5	<input type="radio"/> ECF34B-00EDA-zzxx
# 10-32	<input type="radio"/> ECF34B-00EBA-zzxx

Number of stations (03=3 stations)

** Pressure Regulators :

PR44A-AOxx

- Y=A (no gage port)
- Y=B (with gage port)
- X=A (0 to 100 PSI)
- X=B (0 to 60 PSI)
- X=C (0 to 40 PSI)
- X=D (0 to 15 PSI)

L=Left Side; R=Right Side			
ZZ	Connector	ZZ	Connector
<input type="radio"/> LA	9 Pin Sub D*	<input type="radio"/> RA	9 Pin Sub D*
<input type="radio"/> LB	15 Pin Sub D*	<input type="radio"/> RB	15 Pin Sub D*
<input type="radio"/> LC	25 Pin Sub D*	<input type="radio"/> RC	25 Pin Sub D*
<input type="radio"/> LD	10 Pin Ribbon Cable**	<input type="radio"/> RD	10 Pin Ribbon Cable**
<input type="radio"/> LE	16 Pin Ribbon Cable**	<input type="radio"/> RE	16 Pin Ribbon Cable**
<input type="radio"/> LF	20 Pin Ribbon Cable**	<input type="radio"/> RF	20 Pin Ribbon Cable**
<input type="radio"/> LG	26 Pin Ribbon Cable**	<input type="radio"/> RG	26 Pin Ribbon Cable**
<input type="radio"/> LH	3/8" NPSM Conduit Port Standard Base Wires	<input type="radio"/> RH	3/8" NPSM Conduit Port Standard Base Wires

* MIL. Spec; MIL-C-24308

** MIL. Spec; MIL-C-83503

Note: Left and right end is determined by facing conduit passage.

**TECHNICAL
D A T A**

Fluid :	Compressed air, vacuum, inert gases
Pressure range :	Vacuum to 120 PSI
Lubrication :	Not required, if used select a medium aniline point lubricant (between 180°F and 210°F)
Filtration :	40 µ
Temperature range :	0°F to 120°F (-18°C to +50°C)
Orifice :	1.8 mm
Flow (at 6 bar, ΔP=1bar) :	4 W : 0.10C _v , 2.5 W : 0.09C _v , 1.8 W : 0.07C _v
Leak rate :	
Coil :	General purpose class A, continuous duty, encapsulated
Voltage range :	-15% to +10% of nominal voltage
Power :	4 W - 2.5 W - 1.8 W
Response times :	Energize : 4 ms
(with 4 W coil)	De-energize : 1.5 ms

- Note :
 - Valve and coil are not interchangeable.
- Spare parts :
 - Seal between valve and bar : 16595. • Mounting screw (x2) : 35031. • Blanking plate : M-34005.
 - Blanking plate for regulator : N-44003. • Base wire Plug-in protector : 24180.
- Options :
 - Isolation of inlet and/or exhaust. • BSPP Threads.

DIMENSIONS

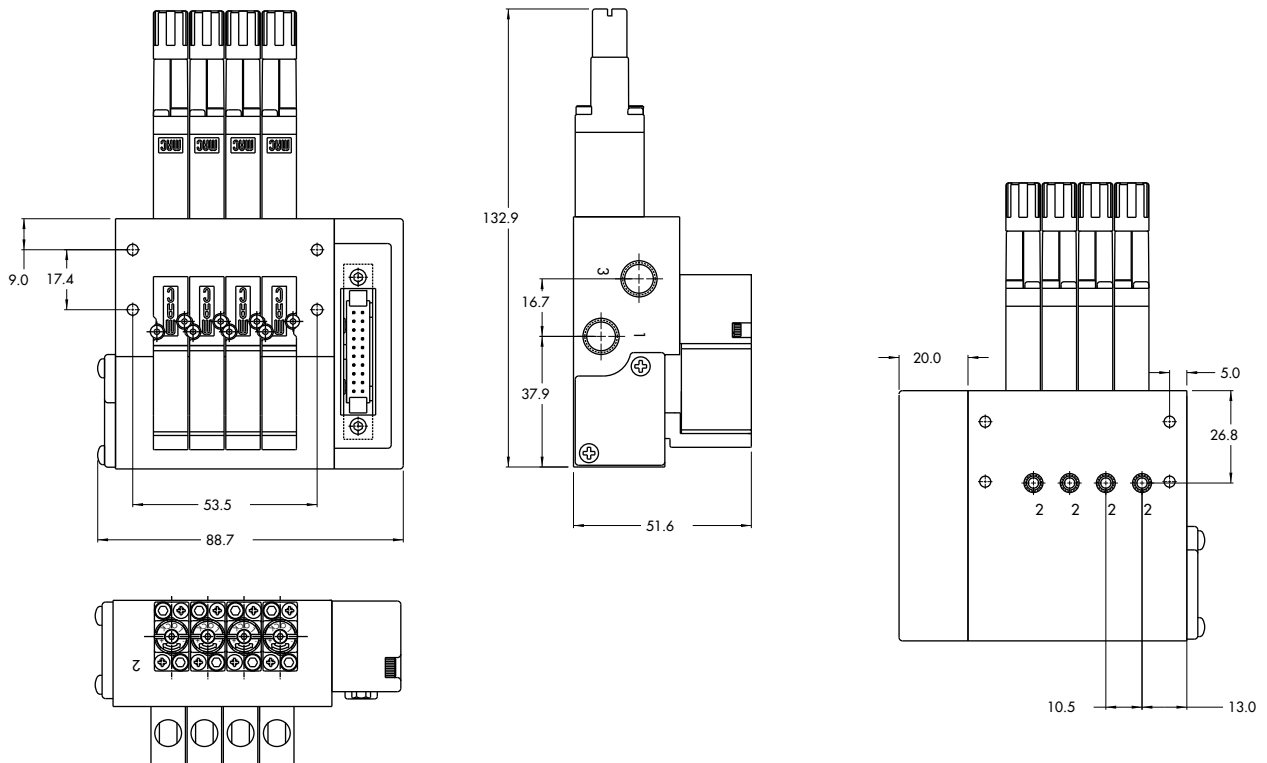

Function	Port size	Flow [Max]	Circuit bar mounting
3/2 NO-NC	M5 - #10-32, 4mm tube receptacle	0.11C_v	din rail, plug-in with pre-wired connector

OPERATIONAL BENEFITS

1. 10 mm valve, direct solenoid operated.
2. Balanced poppet, immune to variations of pressure.
3. Short stroke with high flow.
4. The patented solenoid develops high shifting forces.
5. Powerful return spring.
6. Flow is specifically adjusted on each valve.
7. Manual operator standard on all valves.

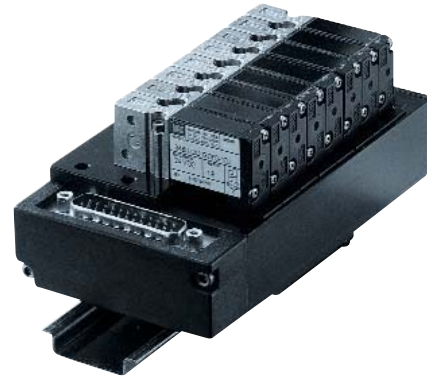

HOW TO ORDER

34B-xxx-GxxO-xxx

HOW TO ORDER VALVE FOR CIRCUIT BAR MOUNTING

Port size (see base)	Universal valve	NC only valve
Valve less base	<input type="radio"/> 34B-100-GxxO-xxx	<input type="radio"/> 34B-NOO-GxxO-xxx

SOLENOID OPERATOR >

G XX O - X XX*

XX Voltage	X Manual operator	XX Electrical connection
<input type="radio"/> DC 24VDC (1.8 W)	<input type="radio"/> 1 Non-locking	<input type="radio"/> DJ Plug-in
<input type="radio"/> DD 24VDC (2.5 W)		<input type="radio"/> DT Plug-in with light
<input type="radio"/> DF 24VDC (4.0 W)		<input type="radio"/> DE Plug-in with suppression diode
<input type="radio"/> xx Other Options		<input type="radio"/> DV Plug-in with light and suppression diode
		<input type="radio"/> xx Other Options

ECF34B-00xxx-xxxx

HOW TO ORDER CIRCUIT BAR

Port size	Side cylinder ports (10.5 mm)
M5	<input type="radio"/> ECF34B-00ADB-zzxx
# 10-32	<input type="radio"/> ECF34B-00ABB-zzxx
4 mm tube receptacle	<input type="radio"/> ECF34B-00AEB-zzxx

Number of stations (03=3 stations)

Din rail spec. (EN50 022)

Note : dlc for valves mounted on base at the factory, add - 9 to the model number.

L=Left Side; R=Right Side

ZZ Connector	ZZ Connector
<input type="radio"/> LA 9 Pin Sub D*	<input type="radio"/> RA 9 Pin Sub D*
<input type="radio"/> LB 15 Pin Sub D*	<input type="radio"/> RB 15 Pin Sub D*
<input type="radio"/> LC 25 Pin Sub D*	<input type="radio"/> RC 25 Pin Sub D*
<input type="radio"/> LD 10 Pin Ribbon Cable**	<input type="radio"/> RD 10 Pin Ribbon Cable**
<input type="radio"/> LE 16 Pin Ribbon Cable**	<input type="radio"/> RE 16 Pin Ribbon Cable**
<input type="radio"/> LF 20 Pin Ribbon Cable**	<input type="radio"/> RF 20 Pin Ribbon Cable**
<input type="radio"/> LG 26 Pin Ribbon Cable**	<input type="radio"/> RG 26 Pin Ribbon Cable**
<input type="radio"/> LH 3/8" NPSM Conduit Port Standard Base Wires	<input type="radio"/> RH 3/8" NPSM Conduit Port Standard Base Wires

* MIL. Spec; MIL-C-24308

** MIL. Spec; MIL-C-83503

Note: Left and right end is determined by facing conduit passage.

**TECHNICAL
DATA**

Fluid :	Compressed air, vacuum, inert gases
Pressure range :	Vacuum to 120 PSI
Lubrication :	Not required, if used select a medium aniline point lubricant (between 180°F and 210°F)
Filtration :	40 µ
Temperature range :	0°F to 120°F (-18°C to +50°C)
Orifice :	1.8 mm
Flow (at 6 bar, ΔP=1bar) :	4 W : 0.11C _v , 2.5 W : 0.09C _v , 1.8 W : 0.06C _v
Coil :	General purpose class A, continuous duty, encapsulated
Voltage range :	-15% to +10% of nominal voltage
Power :	4 W - 2.5 W - 1.8 W
Response times :	Energize : 4 ms
(with 4 W coil)	De-energize : 1.5 ms

- Note : • Valve and coil are not interchangeable.
- Spare parts : • Seal between valve and bar : 16595. • Mounting screw (x2) : 35031. • Blanking plate : M-34005.
• Base wire Plug-in protector : 24180.
- Options : • Isolation of inlet and/or exhaust. • BSPP Threads.

DIMENSIONS

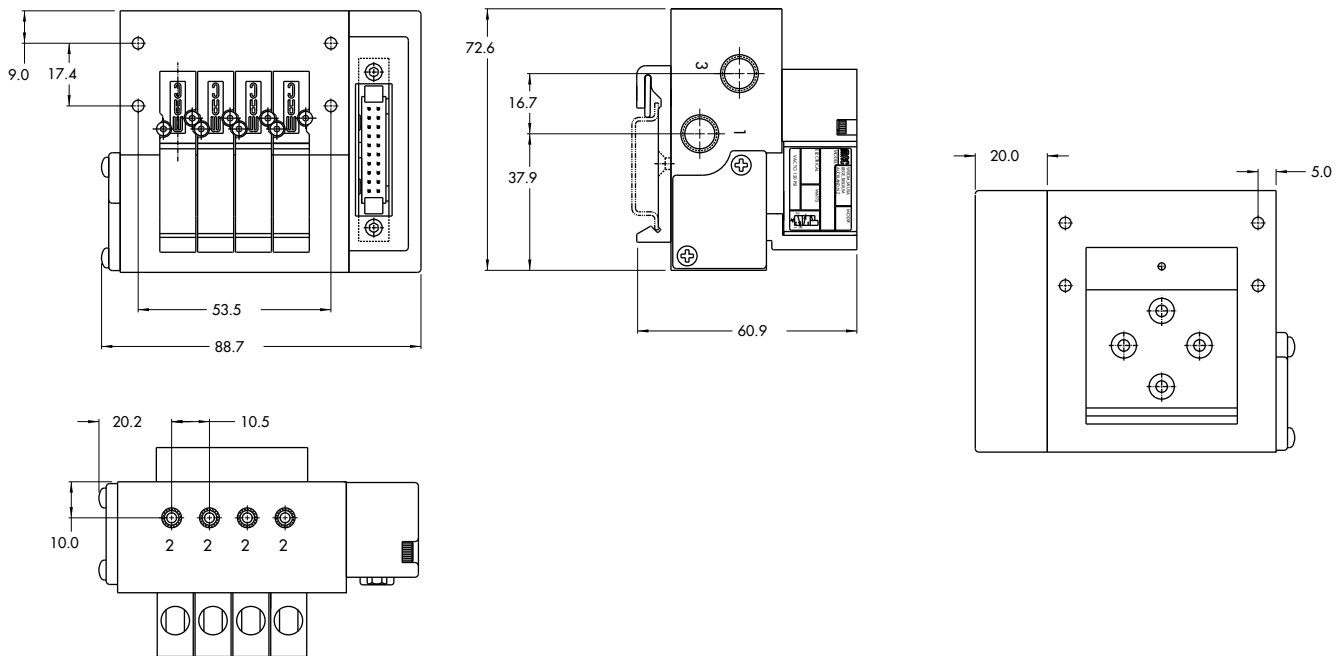

Function	Port size	Flow [Max]	Circuit bar mounting
3/2 NO-NC	M5 - #10-32, 4 mm tube receptacle	0.11C_v	din rail, plug-in with F. C. and pre- wired connector

OPERATIONAL BENEFITS

1. 10 mm valve, direct solenoid operated.
2. Balanced poppet, immune to variations of pressure.
3. Short stroke with high flow.
4. The patented solenoid develops high shifting forces.
5. Powerful return spring.
6. Flow is specifically adjusted on each valve.
7. Manual operator standard on all valves.



HOW TO ORDER

34B-xxx-GxxO-xxx

HOW TO ORDER VALVE FOR CIRCUIT BAR MOUNTING

Port size (see base)	Universal valve	NC only valve
Valve less base	<input type="radio"/> 34B-100-GxxO-xxx	<input type="radio"/> 34B-NOO-GxxO-xxx

SOLENOID OPERATOR >

G XX O - X XX*

XX Voltage	X Manual operator	XX Electrical connection
<input type="radio"/> DC 24VDC (1.8 W)	<input type="radio"/> 1 Non-locking	<input type="radio"/> DJ Plug-in
<input type="radio"/> DD 24VDC (2.5 W)		<input type="radio"/> DT Plug-in with light
<input type="radio"/> DF 24VDC (4.0 W)		<input type="radio"/> DE Plug-in with suppression diode
<input type="radio"/> xx Other Options		<input type="radio"/> DV Plug-in with light and suppression diode
		<input type="radio"/> xx Other Options

ECF34B-00xxx-xxxx

HOW TO ORDER CIRCUIT BAR WITH FLOW CONTROLS

Port size	Side cylinder ports (10.5 mm)
M5	<input type="radio"/> ECF34B-00CDB-zzxx
# 10-32	<input type="radio"/> ECF34B-00CBB-zzxx
4 mm tube receptacle	<input type="radio"/> ECF34B-00CEB-zzxx

Number of stations (03=3 stations)

Din rail spec. (EN50 022)

Note: clic for valves mounted on base at the factory, add - 9 to the model number.

L=Left Side; R=Right Side

ZZ Connector	ZZ Connector
<input type="radio"/> LA 9 Pin Sub D*	<input type="radio"/> RA 9 Pin Sub D*
<input type="radio"/> LB 15 Pin Sub D*	<input type="radio"/> RB 15 Pin Sub D*
<input type="radio"/> LC 25 Pin Sub D*	<input type="radio"/> RC 25 Pin Sub D*
<input type="radio"/> LD 10 Pin Ribbon Cable**	<input type="radio"/> RD 10 Pin Ribbon Cable**
<input type="radio"/> LE 16 Pin Ribbon Cable**	<input type="radio"/> RE 16 Pin Ribbon Cable**
<input type="radio"/> LF 20 Pin Ribbon Cable**	<input type="radio"/> RF 20 Pin Ribbon Cable**
<input type="radio"/> LG 26 Pin Ribbon Cable**	<input type="radio"/> RG 26 Pin Ribbon Cable**
<input type="radio"/> LH 3/8" NPSM Conduit Port Standard Base Wires	<input type="radio"/> RH 3/8" NPSM Conduit Port Standard Base Wires

* MIL. Spec; MIL-C-24308

** MIL. Spec; MIL-C-83503

Note: Left and right end is determined by facing conduit passage.

**TECHNICAL
DATA**

Fluid :	Compressed air, vacuum, inert gases
Pressure range :	Vacuum to 120 PSI
Lubrication :	Not required, if used select a medium aniline point lubricant (between 180°F and 210°F)
Filtration :	40 µ
Temperature range :	0°F to 120°F (-18°C to +50°C)
Orifice :	1.8 mm
Flow (at 6 bar, ΔP=1bar) :	4 W : 0.11C _v , 2.5 W : 0.09C _v , 1.8 W : 0.06C _v
Coil :	General purpose class A, continuous duty, encapsulated
Voltage range :	-15% to +10% of nominal voltage
Power :	4 W - 2.5 W - 1.8 W
Response times :	Energize : 4 ms
(with 4 W coil)	De-energize : 1.5 ms

- Note :
 - Valve and coil are not interchangeable.
- Spare parts :
 - Seal between valve and bar : 16595. • Mounting screw (x2) : 35031. • Blanking plate : M-34005.
 - Base wire Plug-in protector : 24180.
- Options :
 - Isolation of inlet and/or exhaust. • BSPP Threads.

DIMENSIONS

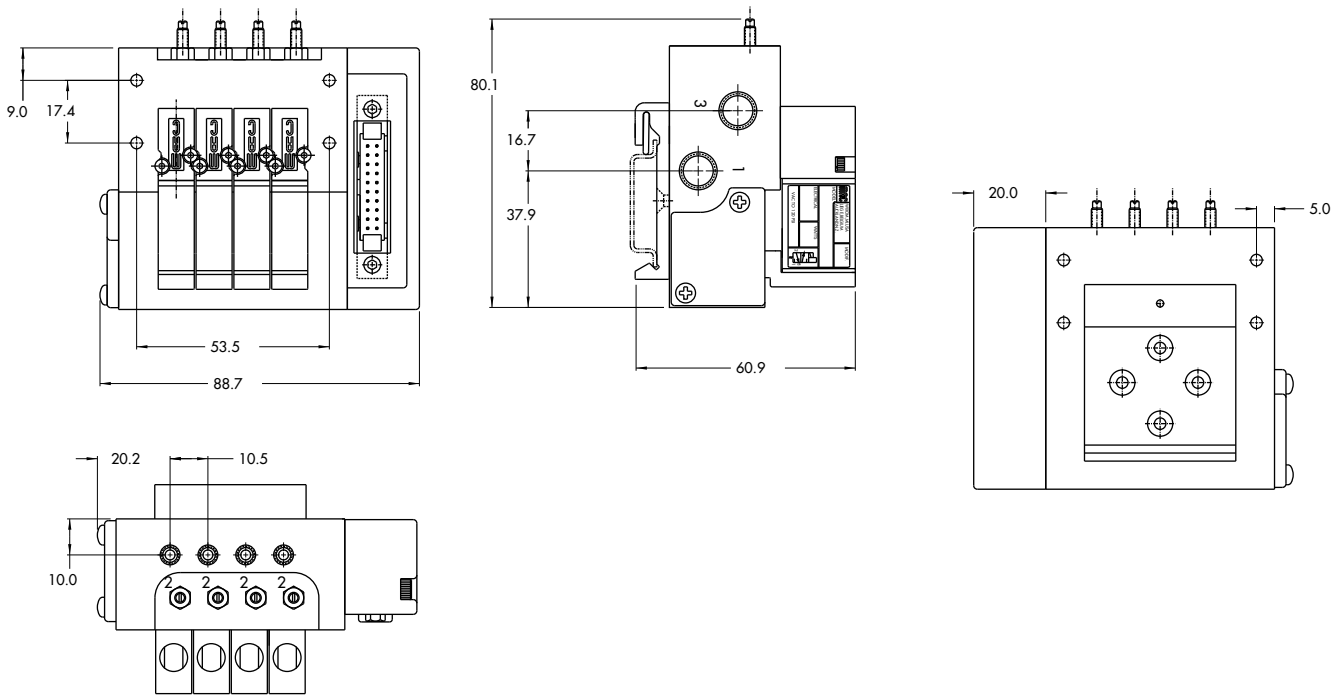



Section 2

Options



0 p t i o n s

Codification table for voltages / Manual operator / Electrical connection

VALVE CODE ► **-GXX X - X XX**
1 2 3 4

OPTIONS AVAILABLE FOR

- solenoid valves 34 & 44 Series

1. VOLTAGE (type 34 Series)		1. VOLTAGE (type 44 Series)	
-G XX X - X XX	VOLTAGE	-G XX X - X XX	VOLTAGE
<input type="radio"/> DC	24 VDC (1,8 W)	<input type="radio"/> DA	24 VDC (1,0 W)
<input type="radio"/> DD	24 VDC (2,5 W)	<input type="radio"/> DC	24 VDC (1,8 W)
<input type="radio"/> DE	24 VDC (3,0 W)	<input type="radio"/> DD	24 VDC (2,5 W)
<input checked="" type="radio"/> DF	24 VDC (4,0 W)	<input type="radio"/> DF	24 VDC (4,0 W)
<input type="radio"/> DJ	12 VDC (1,8 W)	<input type="radio"/> DG	12 VDC (1,0 W)
<input type="radio"/> DK	12 VDC (2,5 W)	<input type="radio"/> DJ	12 VDC (1,8 W)
<input type="radio"/> DM	12 VDC (3,0 W)	<input type="radio"/> DK	12 VDC (2,5 W)
<input type="radio"/> DN	12 VDC (4,0 W)	<input type="radio"/> DN	12 VDC (4,0 W)

2. WIRE LENGTH (Common options for 34 & 44 Series)	
-G XX X - X XX	WIRE LENGTH
<input type="radio"/> A	18"
<input type="radio"/> B	24"
<input type="radio"/> C	36"
<input type="radio"/> D	48"
<input type="radio"/> E	72"
<input type="radio"/> F	96"
<input type="radio"/> G	120"
<input type="radio"/> H	144"



3. MANUAL OPERATOR (COMMON OPTIONS FOR 34 & 44 SERIES)

-G XX X - X XX	MANUAL OPERATOR
1	Non-locking recessed
3	Non-locking extended

4. ELECTRICAL CONNECTION (COMMON OPTIONS FOR 34 & 44 SERIES)

-G XX X - X XX	NO CONNECTOR
<input type="radio"/> BA	Flying leads
<input type="radio"/> BB	BA with ground wire
<input type="radio"/> BC	BA with light
<input type="radio"/> BD	BA with light and ground wire
<input type="radio"/> BE	BA with suppression diode
<input type="radio"/> BF	BA with suppression diode and ground wire
<input type="radio"/> BG	BA with suppression diode and light
<input type="radio"/> BH	BA with suppression diode, light and ground wire
<input type="radio"/> BN	BA with suppression diode and blocking diode
<input checked="" type="radio"/> BP	BA with suppression diode, blocking diode and ground wire
<input type="radio"/> BR	BA with suppression diode, blocking diode and light
<input type="radio"/> BS	BA with suppression diode, blocking diode, light and ground wire
<input type="radio"/> BT	BA with light
<input type="radio"/> BU	BA with light and ground wire
<input type="radio"/> BV	BA with suppression diode and light
<input type="radio"/> BW	BA with suppression diode, light and ground wire
<input type="radio"/> BX	BA with suppression diode, blocking diode and light
<input type="radio"/> BY	BA with suppression diode, blocking diode, light and ground wire

-G XX X - X XX	PLUG-IN CONNECTOR
<input type="radio"/> KA	Mini connector with flying leads
<input type="radio"/> KB	KA with ground wire
<input type="radio"/> KE	KA with suppression diode
<input type="radio"/> KF	KA with suppression diode and ground wire
<input type="radio"/> KJ	Mini connector for KA option
<input type="radio"/> KM	Mini connector for KB option
<input type="radio"/> KN	KA with suppression diode and blocking diode
<input type="radio"/> KP	KA with suppression diode, blocking diode and ground wire
<input type="radio"/> KT	KA with light
<input type="radio"/> KU	KA with light and ground wire
<input type="radio"/> KV	KA with suppression diode and light
<input type="radio"/> KW	KA with suppression diode, light and ground wire
<input type="radio"/> KX	KA with suppression diode, blocking diode and light
<input type="radio"/> KY	KA with suppression diode, blocking diode, light and ground wire

MOD. S009

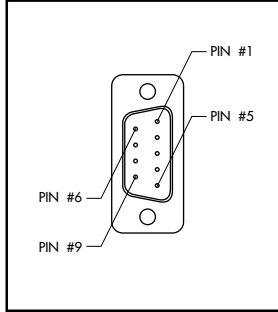

TECHNICAL DATA

- Type «SUB_D»
- Number of contacts : 9
- Solder termination (Dia. 0.6 mm/0.14 mm²/26-22 AWG)
- Operating current 5 A/contact
- Rated voltage 125 V~
- Temp. range -40° to +125°C
- Insulation resistance ≥ 5.0⁹ Ω
- Protection class IP40 (DIN 40050)
- Number of solenoids : 7 max.
- Max. 24 V=/5.4 W per solenoid
- 2 common wires

MOD. S015

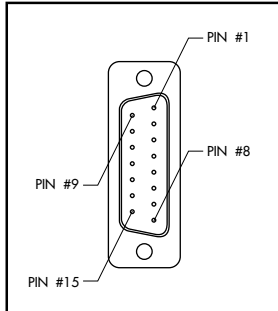

TECHNICAL DATA

- Type «SUB_D»
- Number of contacts : 15
- Solder termination (Dia. 0.6 mm/0.14 mm²/26-22 AWG)
- Operating current 5 A/contact
- Rated voltage 125 V~
- Temp. range -40° to +125°C
- Insulation resistance ≥ 5.0⁹ Ω
- Protection class IP40 (DIN 40050)
- Number of solenoids : 12 max.
- Max. 24 V=/5.4 W per solenoid
- 3 common wires

MOD. S025

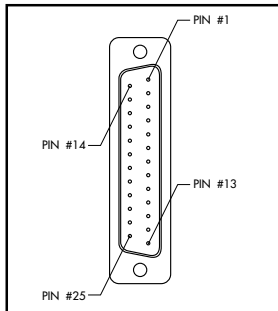

TECHNICAL DATA

- Type «SUB_D»
- Number of contacts : 25
- Solder termination (Dia. 0.6 mm/0.14 mm²/26-22 AWG)
- Operating current 5 A/contact
- Rated voltage 125 V~
- Temp. range -40° to +125°C
- Insulation resistance ≥ 5.0⁹ Ω
- Protection class IP40 (DIN 40050)
- Number of solenoids : 20 max.
- Max. 24 V=/5.4 W per solenoid
- 5 common wires

Note : Use desired MOD. number after circuit bar part number

Connector termination details

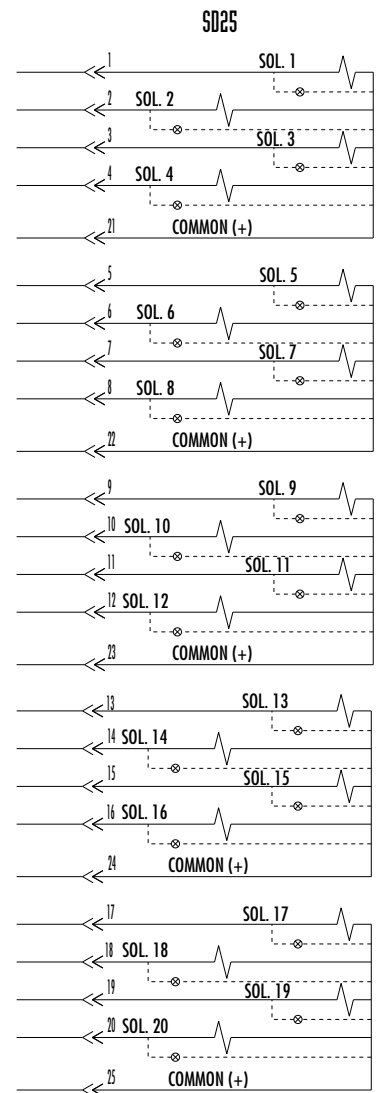
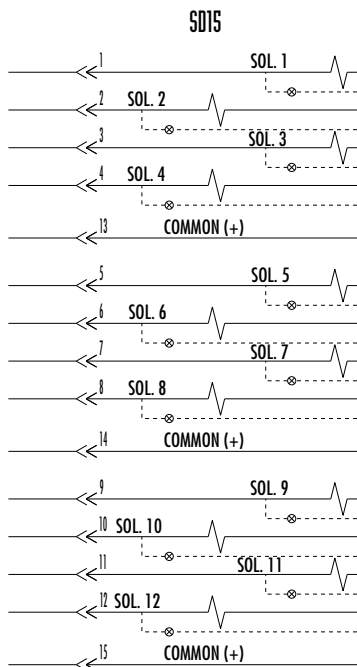
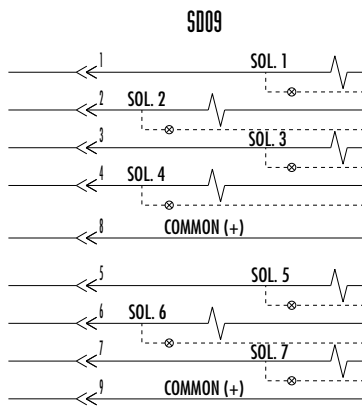
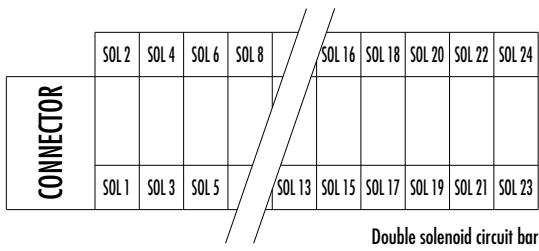
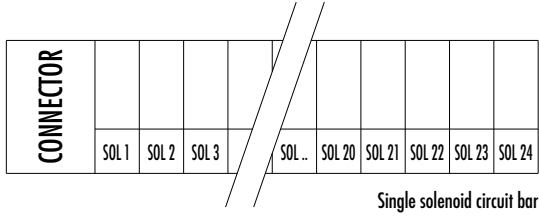

Circuit bar mounting

non plug-in	non plug-in with Pr. Reg.	plug-in	plug-in with side Pr. Reg.	plug-in with integral terminal strip	plug-in with integral terminal strip and side Pr. Reg.
-------------	---------------------------	---------	----------------------------	--------------------------------------	--

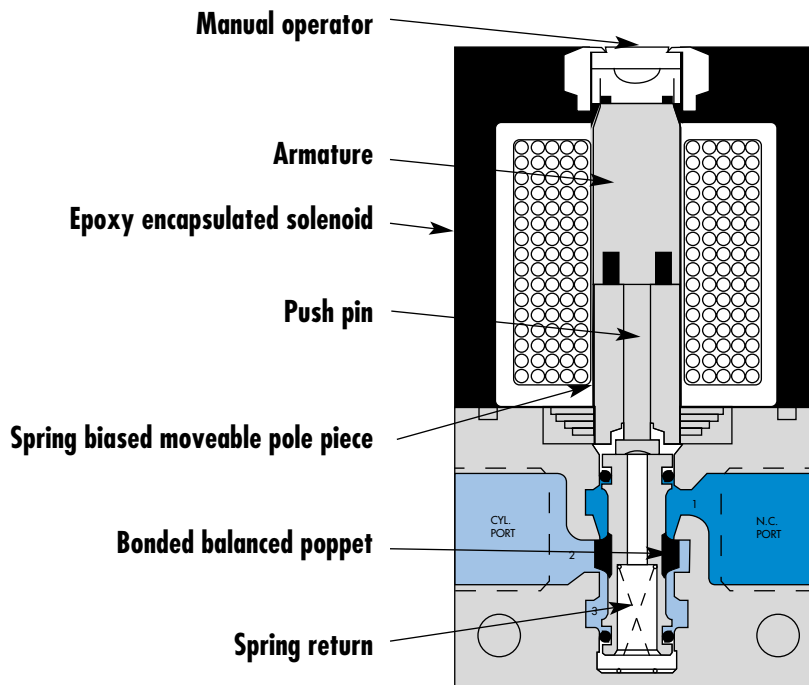

SERIES FEATURES

- Patented MACSOLENOID[®] for fastest possible response times.
- Balanced poppet permits versatility in function :
- 3 way N.C. - 3 way N.O. - Divertor - Selector
- Extremely high cycle rate capability.
- Various solenoid enclosures and plug-in connectors.
- Low wattage DC solenoids - down to 1.8 watts.
- Rated for lubricated or non-lubricated service.

Function	Port size	Flow [Max]	Circuit bar mounting
3/2 NO-NC	1/8" NPTF - #10-32 UNF	0.10C_v	non plug-in

OPERATIONAL BENEFITS

1. Balanced poppet, immune to variations of pressure.
2. Short stroke with high flow.
3. The patented solenoid develops high shifting forces.
4. Powerful return spring.
5. Manual operator standard on all valves.
6. Burn-out proof solenoid on AC service.

Reset



HOW TO ORDER

35A-xxx-Dxxx-xxx

HOW TO ORDER VALVE FOR CIRCUIT BAR MOUNTING

	Universal valve
	
Valve less base	<input type="radio"/> 35A-B00-Dxxx-xxx

SOLENOID OPERATOR >

D **XX X- X XX'**

XX Voltage	X Wire length	X Manual operator	XX Electrical connection
<input type="radio"/> AA 120/60, 110/50	<input type="radio"/> A 18" (Flying leads)	<input type="radio"/> 1 Non-locking Recessed	<input type="radio"/> KA Square connector
<input type="radio"/> AB 240/60, 220/50	<input type="radio"/> J Connector	<input type="radio"/> 2 Locking Recessed	<input type="radio"/> KD Square connector with light
<input type="radio"/> AC 24/60, 24/50	<input type="radio"/> x Other Options	<input type="radio"/> x Other Options	<input type="radio"/> BA Flying leads
<input type="radio"/> FB 24VDC (1.8 W)			<input type="radio"/> xx Other Options
<input type="radio"/> DA 24VDC (5.4 W)			
<input type="radio"/> DF 24VDC (12.7 W)			
<input type="radio"/> xx Other Options			

EBM35A-xxxx-xx

HOW TO ORDER CIRCUIT BAR**

Port size	Side cylinder ports Spacing 21 mm	Bottom cylinder ports Spacing 21 mm
1/8" NPTF	<input type="radio"/> EBM35A-001A-xx	<input type="radio"/> EBM35A-002A-xx
# 10-32 UNF	<input type="radio"/> EBM35A-001B-xx	<input type="radio"/> EBM35A-002B-xx

Number of stations (03=3 stations)

** Other options available. Consult factory.

Note : clic for valves mounted on base at the factory, add - 9 to the model number.

**TECHNICAL
DATA**

Fluid :	Compressed air, vacuum, inert gases		
Pressure range :	Vacuum to 120 PSI		
Lubrication :	Not required, if used select a medium aniline point lubricant (between 180°F and 210°F)		
Filtration :	40 µ		
Temperature range :	0°F to 120°F (-18°C to 50°C)		
Orifice :	2 mm		
Flow (at 6 bar, ΔP=1bar) :	1.8 W : 0.08 C _v , 5.4 W : 0.1 C _v		
Coil :	General purpose class A, continuous duty, encapsulated		
Voltage range :	-15% to +10% of nominal voltage		
Protection :	Nema 4		
Power :	120 VAC/60 = Inrush : 10.9 VA (0.09 AMPS) Holding : 7.7VA (0.06 AMPS) DC VOLTS = 1.8 W to 12.7 W		
Response times :	24 VDC (5.4W)	Energize : 6 ms	De-energize : 2 ms
	120 VAC	Energize : 3-8 ms	De-energize : 2-7 ms

Spare parts :

- Solenoid operator (power ≥ 5.4 W) : DXXX-XXX, including mounting screws 35013.
- Seal between solenoid and valve body : 16402. • Seal between base and valve : 16447.
- Valve mounting screw (x2) : 35020. • Blanking plate valve : M-35004.

Options :

- BSPP threads. • High flow up to 0.14C_v, according to wattage. • Isolation of inlet and/or exhaust.

DIMENSIONS

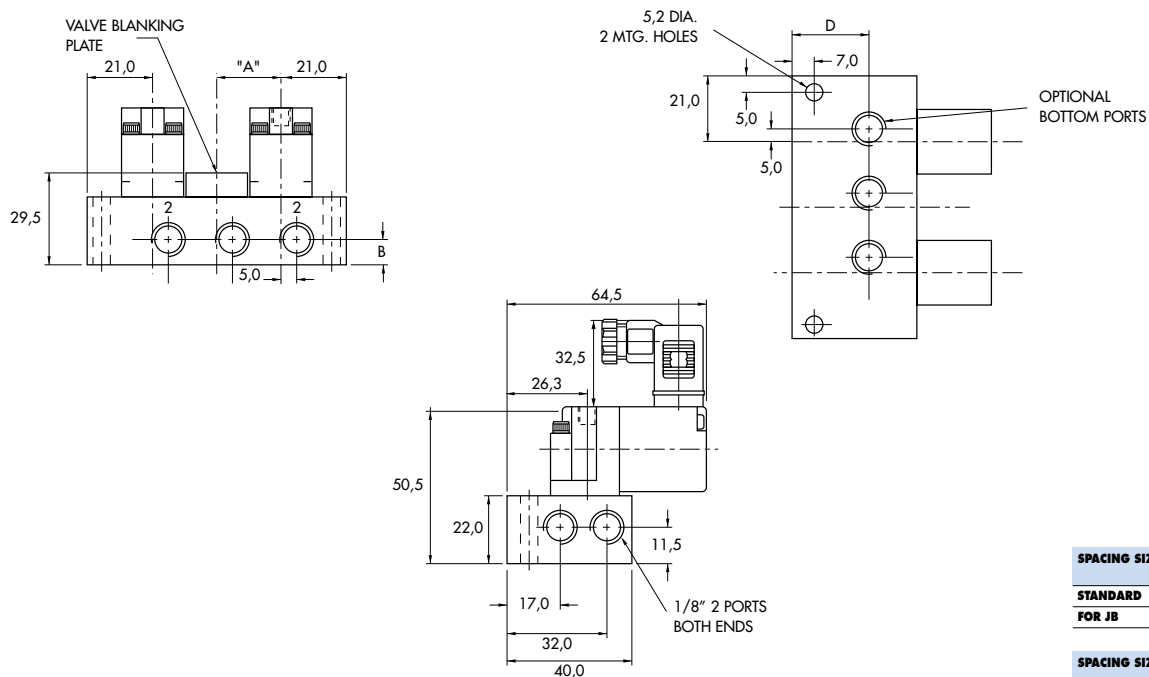

SPACING SIZE	A	
STANDARD	21.0	
FOR JB	26.0	
SPACING SIZE	B	D
1/8"	8.0	24.5
# 10-32	5.5	24.2

Function	Port size	Flow [Max]	Circuit bar mounting
3/2 NO-NC	1/8" NPTF - #10-32 UNF	0.10C_v	non plug-in with Pr. Reg.

OPERATIONAL BENEFITS

1. Balanced poppet, immune to variations of pressure.
2. Short stroke with high flow.
3. The patented solenoid develops high shifting forces.
4. Powerful return spring.
5. Manual operator standard on all valves.
6. Burn-out proof solenoid on AC service.



HOW TO ORDER

35A-xxx-Dxxx-xxx

HOW TO ORDER VALVE FOR CIRCUIT BAR MOUNTING

	Universal valve
Valve less base	<input type="radio"/> 35A-B00-Dxxx-xxx
Valve less base w/ gage port	<input type="radio"/> 35A-F00-Dxxx-xxx

SOLENOID OPERATOR >

D **XX X- X XX**

XX	Voltage	X	Wire length	X	Manual operator	XX	Electrical connection
<input type="radio"/> AA	120/60, 110/50	<input type="radio"/> A	18" (Flying leads)	<input type="radio"/> 1	Non-locking Recessed	<input type="radio"/> KA	Square connector
<input type="radio"/> AB	240/60, 220/50	<input type="radio"/> J	Connector	<input type="radio"/> 2	Locking Recessed	<input type="radio"/> KD	Square connector with light
<input type="radio"/> AC	24/60, 24/50	<input type="radio"/> x	Other Options	<input type="radio"/> x	Other Options	<input type="radio"/> BA	Flying leads
<input type="radio"/> FB	24VDC (1.8 W)					<input type="radio"/> xx	Other Options
<input type="radio"/> DA	24VDC (5.4 W)						
<input type="radio"/> DF	24VDC (12.7 W)						
<input type="radio"/> xx	Other Options						

EBM35A-xxxx-xx

HOW TO ORDER CIRCUIT BAR WITH PRESSURE REGULATORS (TO BE ORDERED SEPARATELY)**

Port size Side cylinder ports	Spacing 21 mm	Spacing 40 mm
1/8" NPTF	<input type="radio"/> EBM35A-003A-xx	<input type="radio"/> EBM35A-023A-xx
# 10-32 UNF	<input type="radio"/> EBM35A-003B-xx	<input type="radio"/> EBM35A-023B-xx
Port size Bottom cylinder ports	Spacing 21 mm	Spacing 40 mm
1/8" NPTF	<input type="radio"/> EBM35A-004A-xx	<input type="radio"/> EBM35A-024A-xx
# 10-32 UNF	<input type="radio"/> EBM35A-004B-xx	<input type="radio"/> EBM35A-024B-xx

Number of stations (03=3 stations)

Other options available. Consult factory.

Note: clic for valves mounted on base at the factory, add - 9 to the model number.
use 40 mm spacing for valves w/ gage port.

** Pressure Regulators :

- 35A-00M (Adjusting knob)
- 35A-00L (Slotted stem)
- 35A-00U (Locking stem)

TECHNICAL
DATA

Fluid :	Compressed air, vacuum, inert gases
Pressure range :	Vacuum to 120 PSI
Lubrication :	Not required, if used select a medium aniline point lubricant (between 180°F and 210°F)
Filtration :	40 µ
Temperature range :	0°F to 120°F (-18°C to 50°C)
Orifice :	2 mm
Flow (at 6 bar, ΔP=1bar) :	1.8 W : 0.08 C _v , 5.4 W : 0.1 C _v
Coil :	General purpose class A, continuous duty, encapsulated
Voltage range :	-15% to +10% of nominal voltage
Protection :	Nema 4
Power :	120 VAC/60 = Inrush : 10.9 VA (0.09 AMPS) Holding : 7.7VA (0.06 AMPS) DC VOLTS = 1.8 W to 12.7 W
Response times :	24 VDC (5.4W) Energize : 6 ms De-energize : 2 ms 120 VAC Energize : 3-8 ms De-energize : 2-7 ms

Spare parts :

- Solenoid operator (power ≥ 5.4 W) : DXXX-XXX, including mounting screws 35013.
- Seal between solenoid and valve body : 16402. • Seal between base and valve : 16447.
- Valve mounting screw (x2) : 35020. • Blanking plate valve : M-35004. • Blanking plate regulator : M-35005.

Options :

- BSPP threads. • High flow up to 0.14C_v, according to wattage. • Isolation of inlet and/or exhaust.

DIMENSIONS

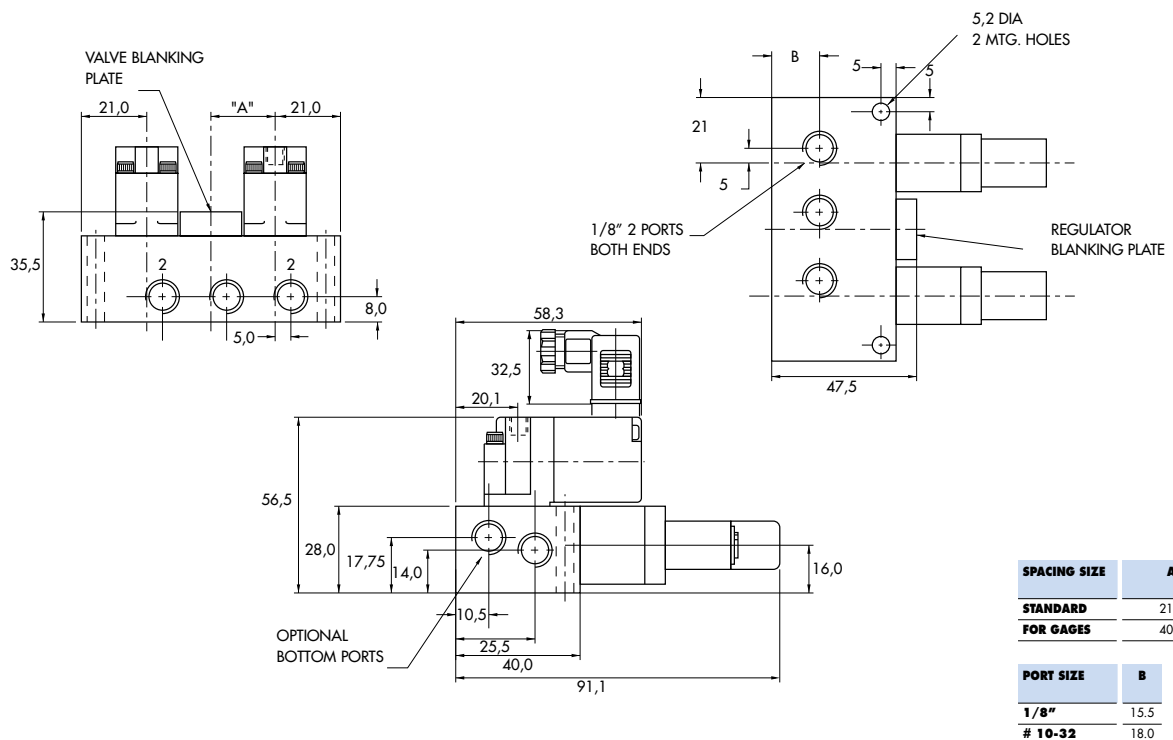

Function	Port size	Flow [Max]	Circuit bar mounting
3/2 NO-NC	1/8" NPTF - #10-32 UNF	0.10C_v	plug-in

OPERATIONAL BENEFITS

1. Balanced poppet, immune to variations of pressure.
2. Short stroke with high flow.
3. The patented solenoid develops high shifting forces.
4. Powerful return spring.
5. Manual operator standard on all valves.
6. Burn-out proof solenoid on AC service.

Reset



HOW TO ORDER

35A-xxx-DxxJ-xFM

HOW TO ORDER VALVE FOR "PLUG-IN" CIRCUIT BAR

	Universal valve
Valve less base	<input type="radio"/> 35A-B00-DxxxJ-xFM

SOLENOID OPERATOR ▶

D xx J- x FM *

XX Voltage	X Manual operator
<input type="radio"/> AA 120/60, 110/50	<input type="radio"/> 1 Non-locking Recessed
<input type="radio"/> AB 240/60, 220/50	<input type="radio"/> 2 Locking Recessed
<input type="radio"/> AC 24/60, 24/50	<input type="radio"/> x Other Options
<input type="radio"/> FB 24VDC (1.8 W)	
<input type="radio"/> DA 24VDC (5.4 W)	
<input type="radio"/> DF 24VDC (12.7 W)	
<input type="radio"/> xx Other Options	

HOW TO ORDER "PLUG-IN" CIRCUIT BAR **

ECD35A-xxxx-xx-xx

Port size	Spacing mm	Side cylinder ports	Bottom cylinder ports
1/8" NPTF	21	<input type="radio"/> ECD35A-001A-A0-xx*	<input type="radio"/> ECD35A-002A-A0-xx*
# 10-32 UNF	21	<input type="radio"/> ECD35A-001B-A0-xx*	<input type="radio"/> ECD35A-002B-A0-xx*
1/8" NPTF	30	<input type="radio"/> ECD35A-031A-C0-xx*	<input type="radio"/> ECD35A-032A-C0-xx*
# 10-32 UNF	30	<input type="radio"/> ECD35A-031B-C0-xx*	<input type="radio"/> ECD35A-032B-C0-xx*

Number of stations (03=3 stations)

** Other options available. Consult factory.

Note : clic for valves mounted on base at the factory, add - 9 to the model number.
 clic for multi-pin connector (9, 15 or 25).

- * A0 = without light
- AA = with light (120V)
- AB = with light (240V)
- AD = with light (24V)
- CO = terminal strip
- CA = terminal w/light (120V)
- CB = terminal w/light (240V)
- CD = terminal w/light (24V)

Function	Port size	Flow [Max]	Circuit bar mounting
3/2 NO-NC	1/8" NPTF - #10-32 UNF	0.10C_v	plug-in with side Pr. Reg.

OPERATIONAL BENEFITS

1. Balanced poppet, immune to variations of pressure.
2. Short stroke with high flow.
3. The patented solenoid develops high shifting forces.
4. Powerful return spring.
5. Manual operator standard on all valves.
6. Burn-out proof solenoid on AC service.

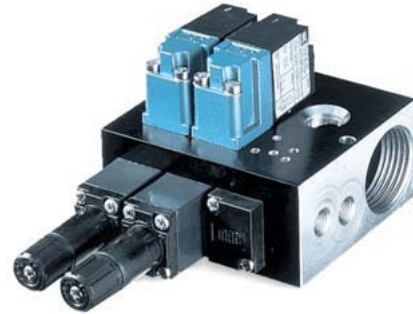

HOW TO ORDER

35A-xxx-DxxJ-xFM

HOW TO ORDER VALVE FOR "PLUG-IN" CIRCUIT BAR

	Universal valve
Valve less base	 <input type="radio"/> 35A-B00-DxxJ-xFM
Valve less base w/ gage port	<input type="radio"/> 35A-F00-DxxJ-xFM

SOLENOID OPERATOR >

D **xx** J- **x** FM *

xx Voltage	x Manual operator
<input type="radio"/> AA 120/60, 110/50	<input type="radio"/> 1 Non-locking Recessed
<input type="radio"/> AB 240/60, 220/50	<input type="radio"/> 2 Locking Recessed
<input type="radio"/> AC 24/60, 24/50	<input type="radio"/> x Other Options
<input type="radio"/> FB 24VDC (1.8 W)	
<input type="radio"/> DA 24VDC (5.4 W)	
<input type="radio"/> DF 24VDC (12.7 W)	
<input type="radio"/> xx Other Options	

ECD35A-xxxx-xx-xx

HOW TO ORDER "PLUG-IN" CIRCUIT BAR WITH PRESSURE REGULATORS (TO BE ORDERED SEPARATELY)* **

Port size	Spacing mm	Bottom cylinder ports
1/8" NPTF	21	<input type="radio"/> ECD35A-004A-A0-xx*
# 10-32 UNF	21	<input type="radio"/> ECD35A-004B-A0-xx*
1/8" NPTF	30	<input type="radio"/> ECD35A-034A-C0-xx*
# 10-32 UNF	30	<input type="radio"/> ECD35A-034B-C0-xx*
1/8" NPTF	40	<input type="radio"/> ECD35A-024A-A0-xx*
# 10-32 UNF	40	<input type="radio"/> ECD35A-024B-A0-xx*

Number of stations (03=3 stations)

** Other options available. Consult factory.

Note: clic for valves mounted on base at the factory, add - 9 to the model number.
 clic for multi-pin connector (9, 15 or 25).
 minimum spacing for terminal strips is 30 mm.
 use 40 mm spacing for valves w/gage port.

** Pressure Regulators :
 35A-00M (Adjusting knob)
 35A-00L (Slotted stem)
 35A-00U (Locking stem)

- * A0 = without light
- AA = with light (120V)
- AB = with light (240V)
- AD = with light (24V)
- C0 = terminal strip
- CA = terminal w/light (120V)
- CB = terminal w/light (240V)
- CD = terminal w/light (24V)

**TECHNICAL
DATA**

Fluid :	Compressed air, vacuum, inert gases
Pressure range :	Vacuum to 120 PSI
Lubrication :	Not required, if used select a medium aniline point lubricant (between 180°F and 210°F)
Filtration :	40 µ
Temperature range :	0°F to 120°F (-18°C to 50°C)
Orifice :	2 mm
Flow (at 6 bar, ΔP=1bar) :	1.8 W : 0.08 C _v , 5.4 W : 0.1 C _v
Coil :	General purpose class A, continuous duty, encapsulated
Voltage range :	-15% to +10% of nominal voltage
Protection :	Nema 4
Power :	120 VAC/60 = Inrush : 10.9 VA (0.09 AMPS) Holding : 7.7VA (0.06 AMPS) DC VOLTS = 1.8 W to 12.7 W
Response times :	24 VDC (5.4W) Energize : 6 ms De-energize : 2 ms 120 VAC Energize : 3-8 ms De-energize : 2-7 ms

Spare parts :

- Solenoid operator (power ≥ 5.4 W) : DXXX-XXX, including mounting screws 35013.
- Seal between solenoid and valve body : 16402. • Seal between base and valve : 16447.
- Valve mounting screw (x2) : 35020. • Blanking plate valve : M-35004. • Blanking plate regulator : M-35005.
- Plug-in protector : 16520.

Options :

- BSPP threads. • High flow up to 0.14C_v, according to wattage. • Isolation of inlet and/or exhaust.

DIMENSIONS

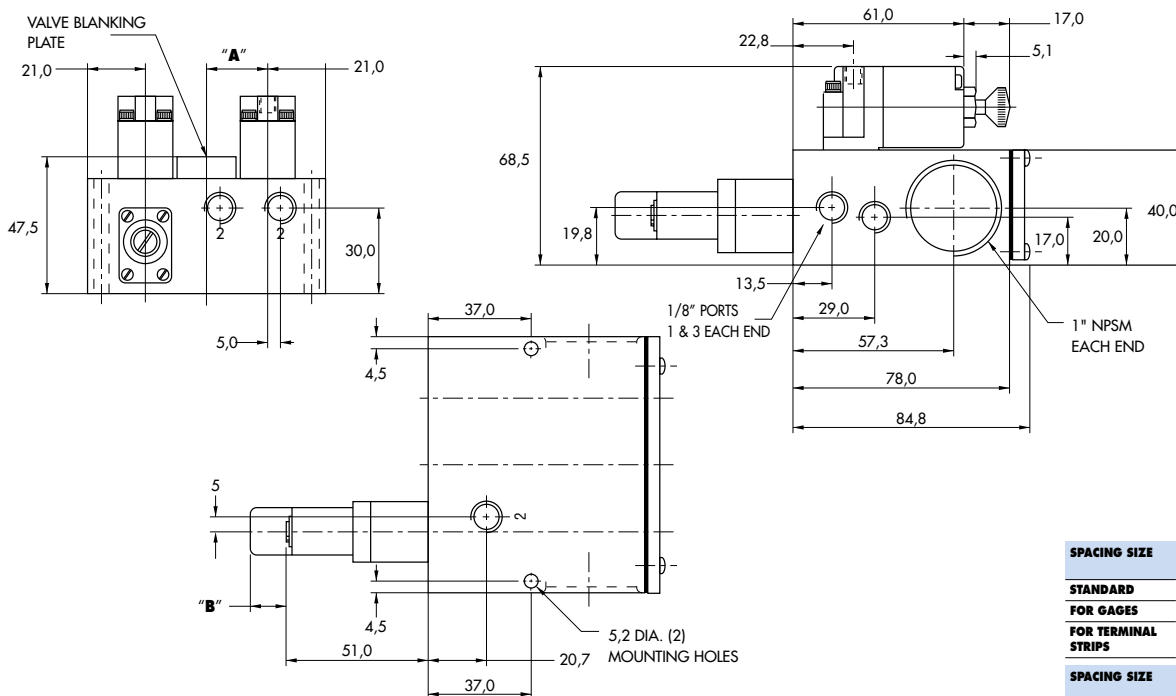

SPACING SIZE	A
STANDARD	21.0
FOR GAGES	40.0
FOR TERMINAL STRIPS	30.0
SPACING SIZE	B
SLOTTED LOCKING STEM	6.0
ADJUSTING KNOB	13.4

Function	Port size	Flow [Max]	Circuit bar mounting
3/2 NO-NC	1/8" NPTF - #10-32 UNF	0.10C_v	plug-in with integral terminal strip

OPERATIONAL BENEFITS

1. Balanced poppet, immune to variations of pressure.
2. Short stroke with high flow.
3. The patented solenoid develops high shifting forces.
4. Powerful return spring.
5. Manual operator standard on all valves.
6. Burn-out proof solenoid on AC service.

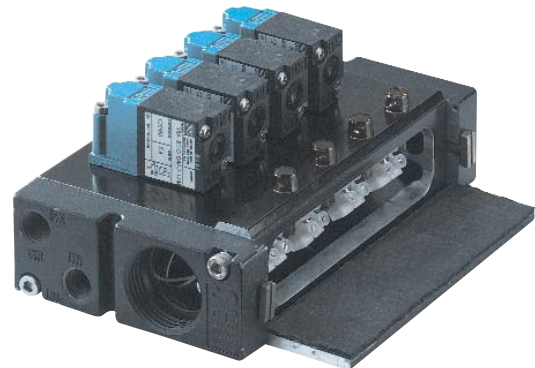

HOW TO ORDER

35A-xxx-DxxJ-xFM

HOW TO ORDER VALVE FOR "PLUG-IN" CIRCUIT BAR

	Universal valve
Valve less base	<input type="radio"/> 35A-B00-DxxJ-xFM

SOLENOID OPERATOR >

D XX J- X FM*

XX Voltage	X Manual operator
<input type="radio"/> AA 120/60, 110/50	<input type="radio"/> 1 Non-locking Recessed
<input type="radio"/> AB 240/60, 220/50	<input type="radio"/> 2 Locking Recessed
<input type="radio"/> AC 24/60, 24/50	<input type="radio"/> x Other Options
<input type="radio"/> FB 24VDC (1.8 W)	
<input type="radio"/> DA 24VDC (5.4 W)	
<input type="radio"/> DF 24VDC (12.7 W)	
<input type="radio"/> xx Other Options	

HOW TO ORDER "PLUG-IN" CIRCUIT BAR **

ECE35A-xxxx-xx-xx

Port size	Spacing mm	Side cylinder ports	Bottom cylinder ports
1/8" NPTF	26	<input type="radio"/> ECE35A-011A-C0-xx*	<input type="radio"/> ECE35A-012A-C0-xx*
# 10-32 UNF	26	<input type="radio"/> ECE35A-011B-C0-xx*	<input type="radio"/> ECE35A-012B-C0-xx*

Number of stations (03=3 stations)

** Other options available. Consult factory.

Note : clic for valves mounted on base at the factory, add - 9 to the model number.
end plate kit required: M-45017.

- * C0 = terminal strip
- CA = terminal strip w/light (120V)
- CB = terminal strip w/light (240V)
- CD = terminal strip w/light (24V)

**TECHNICAL
DATA**

Fluid :	Compressed air, vacuum, inert gases
Pressure range :	Vacuum to 120 PSI
Lubrication :	Not required, if used select a medium aniline point lubricant (between 180°F and 210°F)
Filtration :	40 µ
Temperature range :	0°F to 120°F (-18°C to 50°C)
Orifice :	2 mm
Flow (at 6 bar, ΔP=1bar) :	1.8 W : 0.08 C _v , 5.4 W : 0.1 C _v
Coil :	General purpose class A, continuous duty, encapsulated
Voltage range :	-15% to +10% of nominal voltage
Protection :	Nema 4
Power :	120 VAC/60 = Inrush : 10.9 VA (0.09 AMPS) Holding : 7.7VA (0.06 AMPS) DC VOLTS = 1.8 W to 12.7 W
Response times :	24 VDC (5.4W) Energize : 6 ms De-energize : 2 ms 120 VAC Energize : 3-8 ms De-energize : 2-7 ms

- Spare parts :
- Solenoid operator (power ≥ 5.4 W) : DXXX-XXX, including mounting screws 35013.
 - Seal between solenoid and valve body : 16402. • Seal between base and valve : 16447.
 - Valve mounting screw (x2) : 35020. • Blanking plate valve : M-35004. • Plug-in protector : 16520.
- Options :
- BSPP threads. • High flow up to 0.14C_v, according to wattage. • Isolation of inlet and/or exhaust.

DIMENSIONS

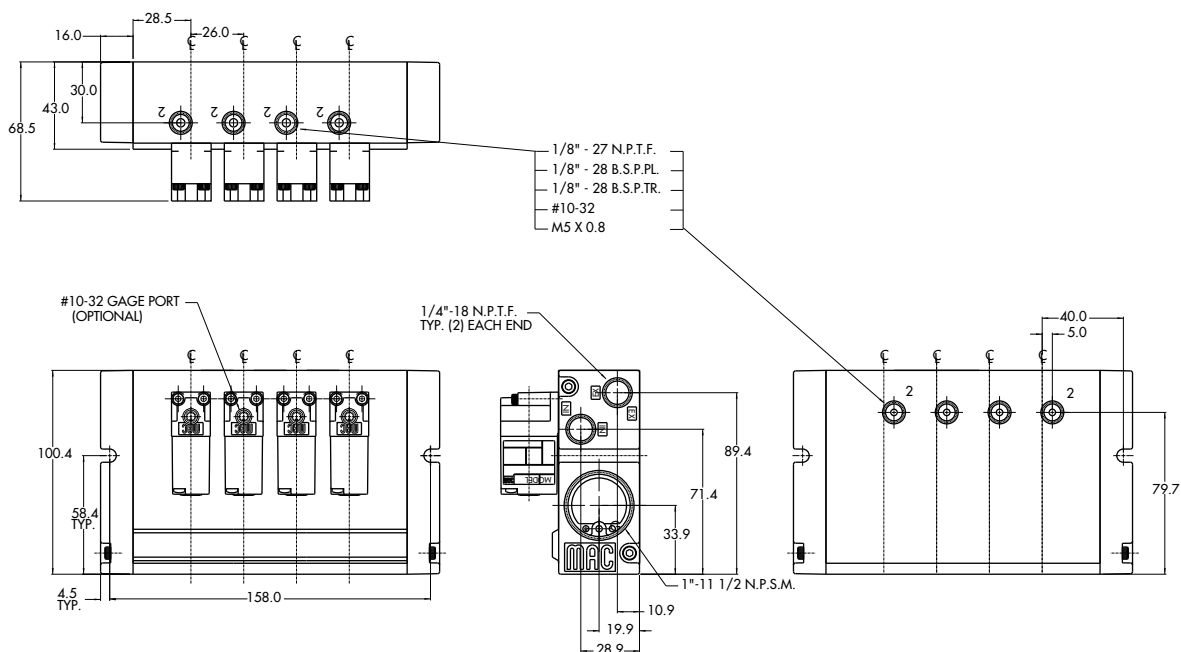

Note: Bottom & side cylinder ports not available on the same station



Direct solenoid and solenoid pilot operated valves

Function	Port size	Flow [Max]	Circuit bar mounting
3/2 NO-NC	1/8" NPTF - #10-32 UNF	0.10C_v	plug-in with integral terminal strip and side Pr. Reg.

OPERATIONAL BENEFITS

- Balanced poppet, immune to variations of pressure.
- Short stroke with high flow.
- The patented solenoid develops high shifting forces.
- Powerful return spring.
- Manual operator standard on all valves.
- Burn-out proof solenoid on AC service.



HOW TO ORDER

35A-xxx-DxxJ-xFM

HOW TO ORDER VALVE FOR "PLUG-IN" CIRCUIT BAR

	Universal valve
Valve less base	 <input type="radio"/> 35A-B00-DxxJ-xFM
Valve less base w/ gage port	<input type="radio"/> 35A-F00-DxxJ-xFM

SOLENOID OPERATOR >

D **XX** J- **X** FM *

XX Voltage	X Manual operator
<input type="radio"/> AA 120/60, 110/50	<input type="radio"/> 1 Non-locking Recessed
<input type="radio"/> AB 240/60, 220/50	<input type="radio"/> 2 Locking Recessed
<input type="radio"/> AC 24/60, 24/50	<input type="radio"/> x Other Options
<input type="radio"/> FB 24VDC (1.8 W)	
<input type="radio"/> DA 24VDC (5.4 W)	
<input type="radio"/> DF 24VDC (12.7 W)	
<input type="radio"/> xx Other Options	

ECE35A-xxxx-xx-xx

HOW TO ORDER "PLUG-IN" CIRCUIT BAR WITH PRESSURE REGULATORS (TO BE ORDERED SEPARATELY)**

Port size	Spacing mm	Bottom cylinder ports
1/8" NPTF	26	<input type="radio"/> ECE35A-014A-C0-xx*
# 10-32 UNF	26	<input type="radio"/> ECE35A-014B-C0-xx*
1/8" NPTF	40	<input type="radio"/> ECE35A-024A-C0-xx*
# 10-32 UNF	40	<input type="radio"/> ECE35A-024B-C0-xx*

Number of stations (03=3 stations)
 Note : clic for valves mounted on base at the factory, add - 9 to the model number.
 use 40 mm spacing for valves w/ gage port.
 end plate kit required: M-45017.

** Pressure Regulators :
 35A-00M (Adjusting knob)
 35A-00L (Slotted stem)
 35A-00U (Locking stem)

* C0 = terminal strip
 CA = terminal strip w/light (120V)
 CB = terminal strip w/light (240V)
 CD = terminal strip w/light (24V)

**TECHNICAL
DATA**

Fluid :	Compressed air, vacuum, inert gases
Pressure range :	Vacuum to 120 PSI
Lubrication :	Not required, if used select a medium aniline point lubricant (between 180°F and 210°F)
Filtration :	40 µ
Temperature range :	0°F to 120°F (-18°C to 50°C)
Orifice :	2 mm
Flow (at 6 bar, ΔP=1bar) :	1.8 W : 0.08 C _v , 5.4 W : 0.1 C _v
Coil :	General purpose class A, continuous duty, encapsulated
Voltage range :	-15% to +10% of nominal voltage
Protection :	Nema 4
Power :	120 VAC/60 = Inrush : 10.9 VA (0.09 AMPS) Holding : 7.7VA (0.06 AMPS) DC VOLTS = 1.8 W to 12.7 W
Response times :	24 VDC (5.4W) Energize : 6 ms De-energize : 2 ms 120 VAC Energize : 3-8 ms De-energize : 2-7 ms

- Spare parts :
- Solenoid operator (power ≥ 5.4 W) : DXXX-XXX, including mounting screws 35013.
 - Seal between solenoid and valve body : 16402. • Seal between base and valve : 16447.
 - Valve mounting screw (x2) : 35020. • Blanking plate valve : M-35004. • Blanking plate regulator : M-35005.
 - Plug-in protector : 16520.
- Options :
- BSPP threads. • High flow up to 0.14C_v, according to wattage. • Isolation of inlet and/or exhaust.

DIMENSIONS

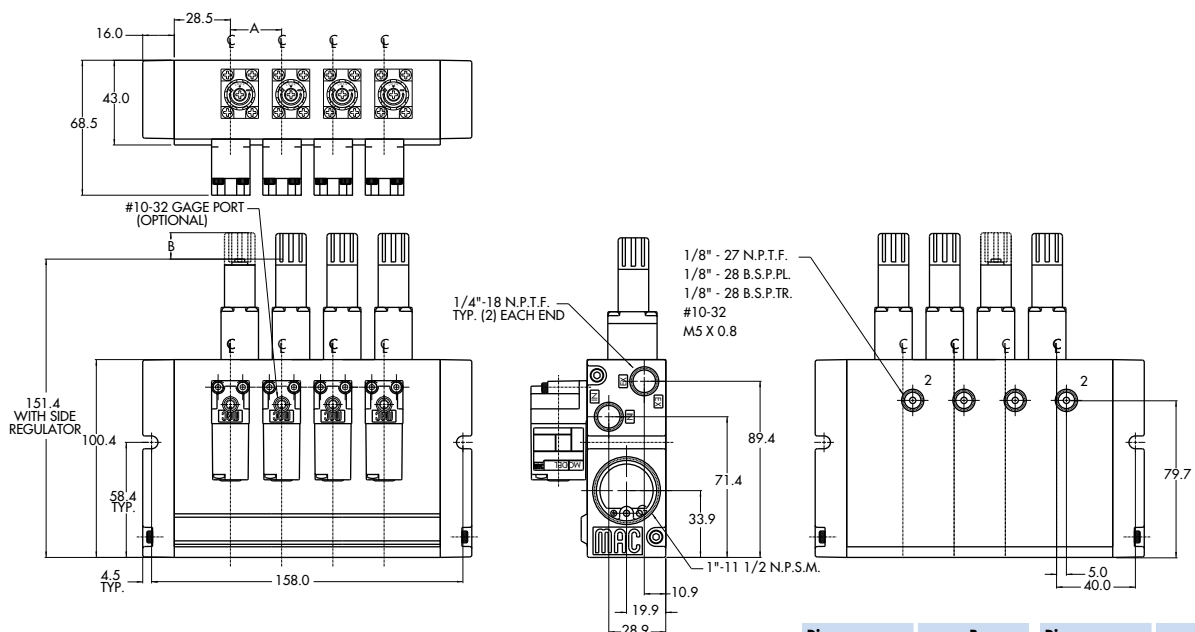

Dim.	B	Dim.	A
SLOTTED LOCKING STEM	6.0	STANDARD SPACING	26.0
ADJUSTABLE KNOB	13.4	SPACING FOR GAUGES	40.0



Section 2

Options



0 p t i o n s

Codification table for voltages / Wire length / Manual operators / Electrical connections

VALVE CODE ➤

-DXX X - X XX
1 2 3 4

OPTIONS AVAILABLE FOR

- Solenoid valves 35 & 45 Series

1. VOLTAGE

- D XX	X - X XX	VOLTAGE
<input type="radio"/>	AD	24/60
<input type="radio"/>	AE	200/60
<input type="radio"/>	AF	240/50
<input type="radio"/>	AG	100/50, 100/60, 110/60
<input type="radio"/>	DB	12 VDC (5.4 W)
<input type="radio"/>	DC	12 VDC (7.5 W)
<input type="radio"/>	DD	24 VDC (7.3 W)
<input type="radio"/>	DE	12 VDC (12.7 W) CLSF
<input type="radio"/>	DK	110 VDC (5.8 W)
<input type="radio"/>	DL	64 VDC (6.0 W)
<input type="radio"/>	DM	36 VDC (5.8 W)
<input type="radio"/>	DN	6 VDC (6.0 W)
<input type="radio"/>	DP	48 VDC (5.8 W)
<input type="radio"/>	DU	24 VDC (6.0 W)
<input type="radio"/>	EA	12 VDC (6.0 W)
<input type="radio"/>	FA	12 VDC (1.8 W)
<input type="radio"/>	FE	12 VDC (2.4 W)
<input type="radio"/>	FF	24 VDC (2.4 W)

2. WIRE LENGTH

- D XX	X - X XX	WIRE LENGTH
<input type="radio"/>	B	24"
<input type="radio"/>	C	36"
<input type="radio"/>	D	48"
<input type="radio"/>	E	72"
<input type="radio"/>	F	96"



3. MANUAL OPERATOR

- D XX X - X XX	MANUAL OPERATOR
<input type="radio"/> 0	No operator
<input type="radio"/> 1	Non-locking recessed
<input type="radio"/> 2	Locking recessed
<input type="radio"/> 3	Non-locking extended
<input type="radio"/> 4	Locking extended

4. ELECTRICAL CONNECTION

- D XX X - X XX	ELECTRICAL CONNECTION
<input type="radio"/> BA	Flying leads
<input type="radio"/> BK	BA with protection diode
<input type="radio"/> BL	BA with protection varistor
<input type="radio"/> CA	1/2" NPS conduit
<input type="radio"/> *FN	Plug-in with diode
<input type="radio"/> *FP	Plug-in with M.O.V.
<input type="radio"/> JB	Rectangular connector
<input type="radio"/> JD	Rectangular connector with light
<input type="radio"/> JM	Rectangular connector, male only
<input type="radio"/> KA	Square connector
<input type="radio"/> KB	Square connector with protection diode
<input type="radio"/> KC	Square connector with protection varistor
<input type="radio"/> KD	Square connector with light
<input type="radio"/> KE	Square connector with light and protection diode
<input type="radio"/> KF	Square connector with light and protection varistor
<input type="radio"/> KJ	Square connector (male only)
<input type="radio"/> KK	Square connector with protection diode (male only)
<input type="radio"/> KL	Square connector with protection varistor (male only)
<input type="radio"/> TA	Dual tabs
<input type="radio"/> TB	TA with protection diode
<input type="radio"/> TD	TA with light
<input type="radio"/> TE	TA with light and protection diode
<input type="radio"/> TJ	Dual tabs (male only)
<input type="radio"/> TK	TJ with protection diode
<input type="radio"/> TM	TJ with light
<input type="radio"/> TN	TJ with light and protection diode

* For use with the ECD and ECE style circuit bars.

MOD. S009

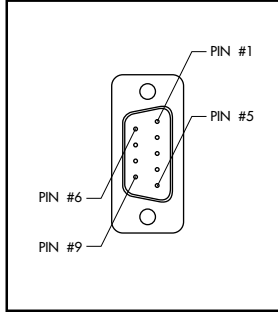

TECHNICAL DATA

- Type «SUB_D»
- Number of contacts : 9
- Solder termination (Dia. 0.6 mm/0.14 mm²/26-22 AWG)
- Operating current 5 A/contact
- Rated voltage 125 V~
- Temp. range -40° to +125°C
- Insulation resistance ≥ 5.0⁹ Ω
- Protection class IP40 (DIN 40050)
- Number of solenoids : 7 max.
- Max. 24 V=/5.4 W per solenoid
- 2 common wires

MOD. S015

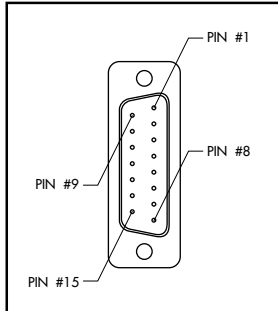

TECHNICAL DATA

- Type «SUB_D»
- Number of contacts : 15
- Solder termination (Dia. 0.6 mm/0.14 mm²/26-22 AWG)
- Operating current 5 A/contact
- Rated voltage 125 V~
- Temp. range -40° to +125°C
- Insulation resistance ≥ 5.0⁹ Ω
- Protection class IP40 (DIN 40050)
- Number of solenoids : 12 max.
- Max. 24 V=/5.4 W per solenoid
- 3 common wires

MOD. S025

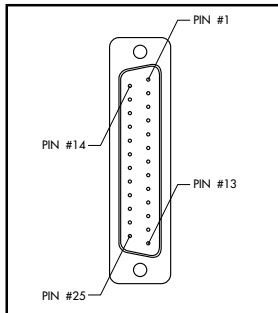

TECHNICAL DATA

- Type «SUB_D»
- Number of contacts : 25
- Solder termination (Dia. 0.6 mm/0.14 mm²/26-22 AWG)
- Operating current 5 A/contact
- Rated voltage 125 V~
- Temp. range -40° to +125°C
- Insulation resistance ≥ 5.0⁹ Ω
- Protection class IP40 (DIN 40050)
- Number of solenoids : 20 max.
- Max. 24 V=/5.4 W per solenoid
- 5 common wires

Note : Use desired MOD. number after circuit bar part number

Connector termination details

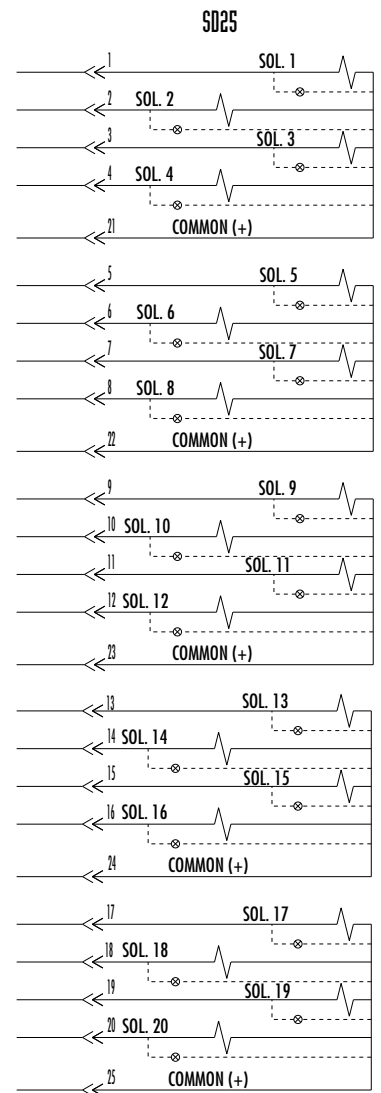
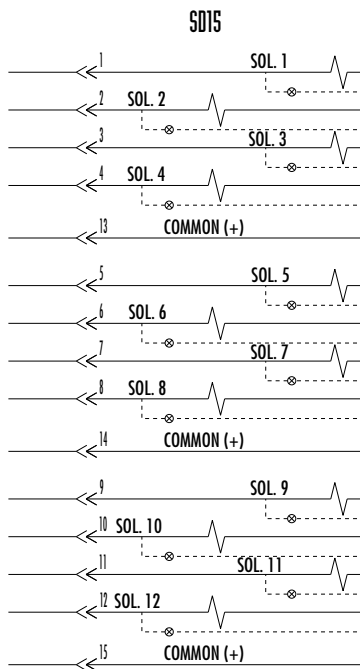
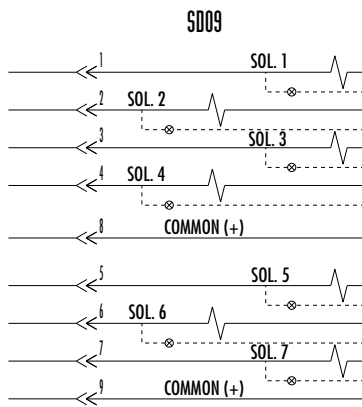
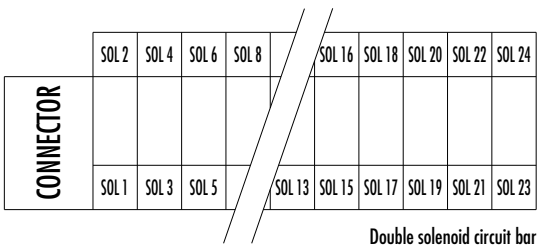
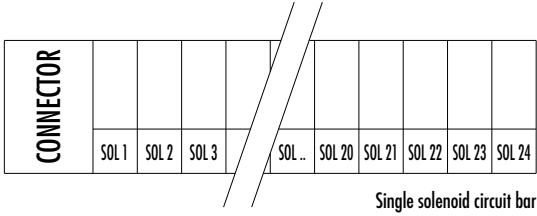

Circuit bar mounting

non plug-in cylinder ports in valve	non plug-in cylinder ports in base	non plug-in cylinder ports in base with Pr. Reg.	non plug-in add-on style cylinder ports in base	non plug-in add-a-unit stations	plug-in	plug-in with Pr. Reg.	add-on style plug-in
add-on style plug in with Pr. Reg.	plug-in add-a-unit stations	plug-in add-a-unit stations with Pr. Reg.					

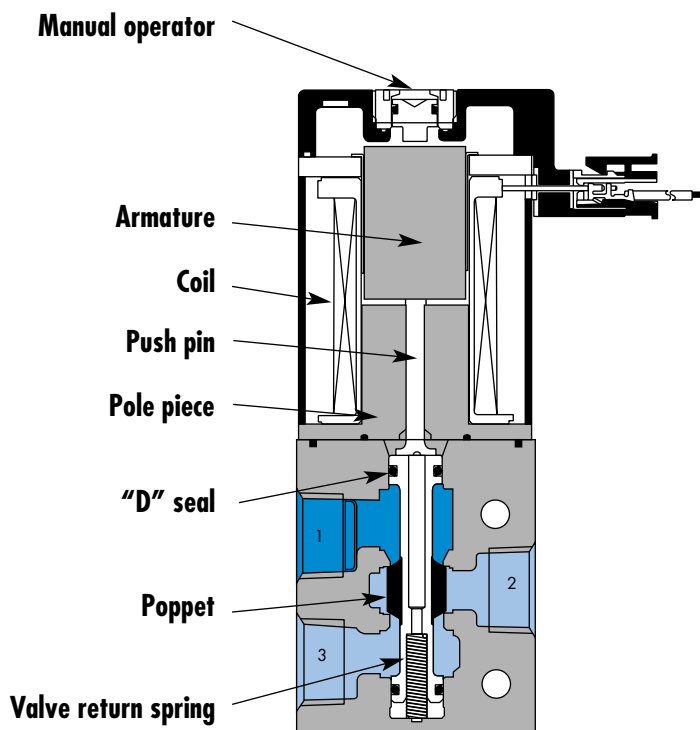

SERIES FEATURES

- Balanced poppet equals consistent high shifting forces.
- Valve shifting forces are consistent and independent of pressure fluctuations.
- High solenoid and return spring forces ensure high speed and precise repeatability.
- Built-in wear compensation - valve stroke is shorter than solenoid stroke.
- Constant high flow maintained throughout the pressure range.
- Exhaust contaminants are isolated from the solenoid.
- Full flow exhaust.
- Universal porting - 6 functions in one valve.

Function	Port size (Inlet & Exhaust)	Flow (Max)	Circuit bar mounting	Profile
3/2 NO-NC	1/4" - 3/8"	0.5C_v	non plug-in cylinder ports in valve	26 mm 38 mm

OPERATIONAL BENEFITS

1. Direct solenoid operated valve.
2. Balanced poppet, immune to variations of pressure.
3. Short stroke with high flow.
4. The patented solenoid develops high shifting forces.
5. Powerful return spring.
6. Manual operator standard on all valves.

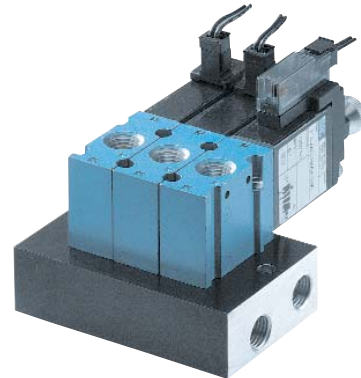

HOW TO ORDER

37A-xxx-Hxxx-xxx

HOW TO ORDER VALVE FOR CIRCUIT BAR MOUNTING

Valve port size	Universal valve	NC only valve
1/8" NPTF	<input type="radio"/> 37A-EGO-Hxxx-xxx	<input type="radio"/> 37A-FGO-Hxxx-xxx
1/4" NPTF	<input type="radio"/> 37A-EHO-Hxxx-xxx	<input type="radio"/> 37A-FHO-Hxxx-xxx

SOLENOID OPERATOR >

H **XX X- X XX**

XX Voltage	X Wire length	X Manual operator	XX Electrical connection
<input type="radio"/> DC 24VDC (1.8 W)	<input type="radio"/> A 18"	<input type="radio"/> 1 Non-locking	<input type="radio"/> MA Plug-in wire assy
<input type="radio"/> DB 24VDC (2.4 W)	<input type="radio"/> C 36"		<input type="radio"/> MC Plug-in wire assy with light
<input type="radio"/> DA 24VDC (5.2 W)	<input type="radio"/> x Other Options		<input type="radio"/> BA Flying leads
<input type="radio"/> AA 120VAC (must use with rectified connector)			<input type="radio"/> BC Flying leads with light
<input type="radio"/> xx Other Options			<input type="radio"/> HA Plug-in connector with rectifier and light
			<input type="radio"/> xx Other Options

EBM37A-xxxxx-xx

HOW TO ORDER CIRCUIT BAR (REGULATORS ORDERED SEPARATELY)**

Port size COMMON INLET & EXHAUST	Without regulators (20mm)	With regulators (20mm)
26mm Profile 1/4" NPTF	<input type="radio"/> EBM37A-01CAK-xx	-
38mm Profile 3/8" NPTF	-	<input type="radio"/> EBM37A-01JAK-xx

Number of stations (03=3 stations)

Note : clic for valves mounted on base at the factory, add - 9 to the model number.

** Pressure Regulators :

PR37A-GOAx

- X=A (0 to 120 PSI)
- X=B (0 to 80 PSI)
- X=C (0 to 30 PSI)

**TECHNICAL
DATA**

Fluid :	Compressed air, vacuum, inert gases
Pressure range :	Vacuum to 120 PSI
Lubrication :	Not required, if used select a medium aniline point lubricant (between 180°F and 210°F)
Filtration :	40 µ
Temperature range :	0°F to 120°F (-18°C to 50°C)
Orifice :	4.3 mm
Flow (at 6 bar, ΔP=1bar) :	5.2 W : 0.50C _v , 2.4 W : 0.25C _v , 1.8 W : 0.15C _v
Coil :	General purpose class A, continuous duty, encapsulated
Voltage range :	-15% to +10% of nominal voltage
Power :	5.2 W - 2.4 W - 1.8 W - 1.0 W
Response times :	Energize : 17.0 ms
(with 5.2 W coil)	De-energize : 6.0 ms

- Note : • Valve and coil are not interchangeable.
- Spare parts : • Seal between valve and bar : 16630. • Mounting screw (x2) : 35043. • Blanking plate : M-37002.
• Regulator blanking plate : R-47003.
- Options : • Isolation of inlet and/or exhaust. Special bar. Consult factory. • BSPP Threads.

DIMENSIONS

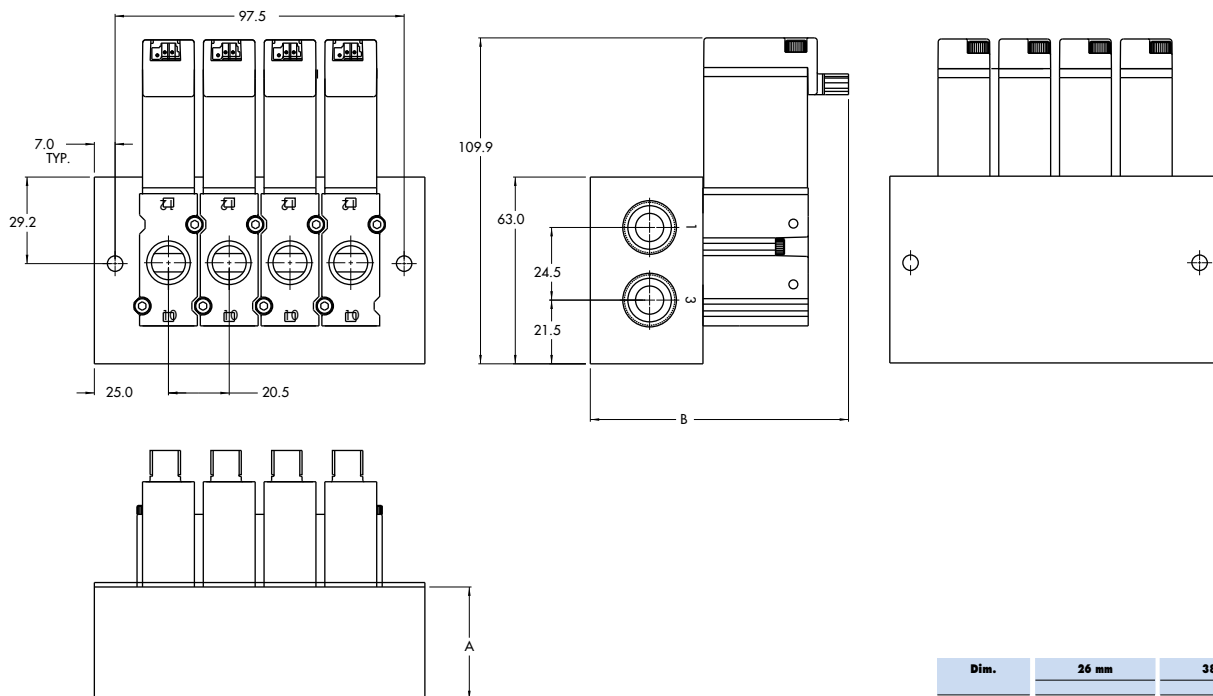

Function	Port size	Flow [Max]	Circuit bar mounting	Profile
3/2 NO-NC	1/8" - 1/4" 6 mm tube receptacle	0.5C_v	non plug-in cylinder ports in base	26 mm

OPERATIONAL BENEFITS

1. Direct solenoid operated valve.
2. Balanced poppet, immune to variations of pressure.
3. Short stroke with high flow.
4. The patented solenoid develops high shifting forces.
5. Powerful return spring.
6. Manual operator standard on all valves.

Reset

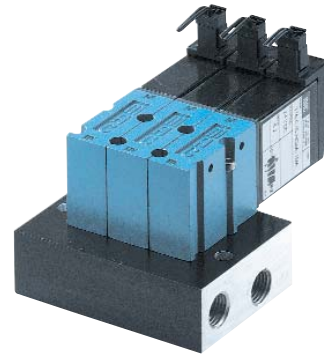

HOW TO ORDER

37A-xxx-Hxxx-xxx

HOW TO ORDER VALVE FOR CIRCUIT BAR MOUNTING

Port size (see base)	Universal valve	NC only valve
Valve less base	<input type="radio"/> 37A-C10-Hxxx-xxx	<input type="radio"/> 37A-D10-Hxxx-xxx

SOLENOID OPERATOR >

H XX X- X XX'

XX Voltage	X Wire length	X Manual operator	XX Electrical connection
<input type="radio"/> DC 24VDC (1.8 W)	<input type="radio"/> A 18"	<input type="radio"/> 1 Non-locking	<input type="radio"/> MA Plug-in wire assy
<input type="radio"/> DB 24VDC (2.4 W)	<input type="radio"/> C 36"		<input type="radio"/> MC Plug-in wire assy with light
<input type="radio"/> DA 24VDC (5.2 W)	<input type="radio"/> X Other Options		<input type="radio"/> BA Flying leads
<input type="radio"/> AA 120VAC (must use with rectified connector)			<input type="radio"/> BC Flying leads with light
<input type="radio"/> xx Other Options			<input type="radio"/> HA Plug-in connector with rectifier and light
			<input type="radio"/> xx Other Options

EBM37A-00xxx-xx

HOW TO ORDER CIRCUIT BAR

Port size	Side cylinder ports (18 mm)	Bottom cylinder ports (18 mm)
1/8" NPTF	<input type="radio"/> EBM37A-00AAA-xx	<input type="radio"/> EBM37A-00BAA-xx
1/4" NPTF	<input type="radio"/> EBM37A-00AAB-xx	<input type="radio"/> EBM37A-00BAB-xx
6 mm tube receptacle	<input type="radio"/> EBM37A-00AAG-xx	<input type="radio"/> EBM37A-00BAG-xx

Number of stations (03=3 stations)

Note: clic for valves mounted on base at the factory, add - 9 to the model number.

**TECHNICAL
DATA**

Fluid :	Compressed air, vacuum, inert gases
Pressure range :	Vacuum to 120 PSI
Lubrication :	Not required, if used select a medium aniline point lubricant (between 180°F and 210°F)
Filtration :	40 µ
Temperature range :	0°F to 120°F (-18°C to 50°C)
Orifice :	4.3 mm
Flow (at 6 bar, ΔP=1bar) :	5.2 W : 0.50C _v , 2.4 W : 0.25C _v , 1.8 W : 0.15C _v
Coil :	General purpose class A, continuous duty, encapsulated
Voltage range :	-15% to +10% of nominal voltage
Power :	5.2 W - 2.4 W - 1.8 W - 1.0 W
Response times :	Energize : 17.0 ms
(with 5.2 W coil)	De-energize : 6.0 ms

- Note : • Valve and coil are not interchangeable.
- Spare parts : • Seal between valve and bar : 16630. • Mounting screw (x2) : 35043. • Blanking plate : M-37001.
- Options : • Isolation of inlet and/or exhaust. Special bar. Consult factory. • BSPP Threads.

DIMENSIONS

Dim.	1/4"	M6 Carstick
"B"	16.5	18.5

Number of stations	1	2	3	4	5	6	7	8	9	10
"A"	50.0	68.0	86.0	104.0	122.0	140.0	158.0	176.0	194.0	212.0

Dimensions are based on 18 mm centerline spacing

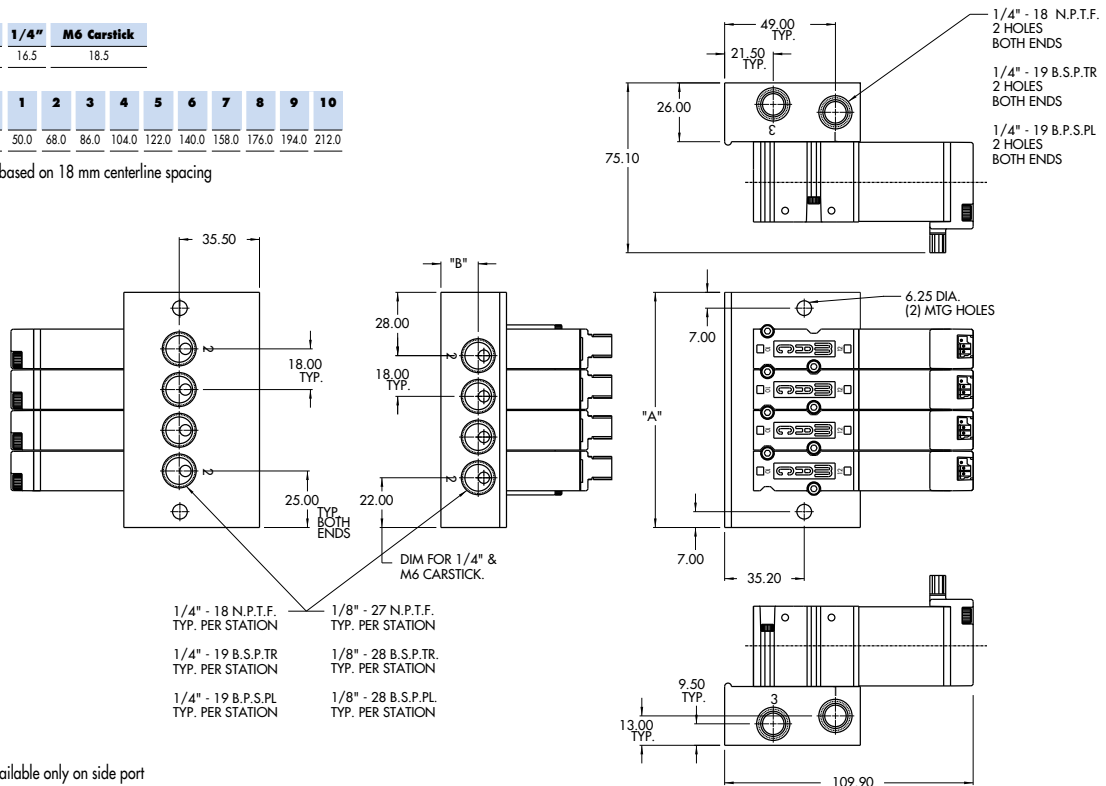

* M6 Carstick available only on side port

Function	Port size	Flow [Max]	Circuit bar mounting	Profile
3/2 NO-NC	1/8" - 1/4" 6 mm tube receptacle	0.5C_v	non plug-in cylinder ports in base with Pr. Reg.	38 mm

OPERATIONAL BENEFITS

1. Direct solenoid operated valve.
2. Balanced poppet, immune to variations of pressure.
3. Short stroke with high flow.
4. The patented solenoid develops high shifting forces.
5. Powerful return spring.
6. Manual operator standard on all valves.

Reset

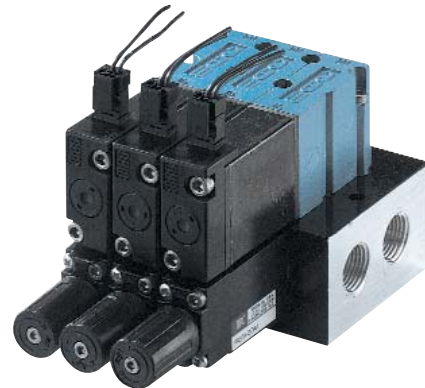

HOW TO ORDER

37A-xxx-Hxxx-xxx

HOW TO ORDER VALVE FOR CIRCUIT BAR MOUNTING

Port size (see base)	Universal valve	NC only valve
Valve less base	<input type="radio"/> 37A-C1O-Hxxx-xxx	<input type="radio"/> 37A-D1O-Hxxx-xxx

SOLENOID OPERATOR >

H XX X- X XX'

Voltage	Wire length	Manual operator	Electrical connection
<input type="radio"/> DC 24VDC (1.8 W)	<input type="radio"/> A 18"	<input type="radio"/> 1 Non-locking	<input type="radio"/> MA Plug-in wire assy
<input type="radio"/> DB 24VDC (2.4 W)	<input type="radio"/> C 36"		<input type="radio"/> MC Plug-in wire assy with light
<input type="radio"/> DA 24VDC (5.2 W)	<input type="radio"/> X Other Options		<input type="radio"/> BA Flying leads
<input type="radio"/> AA 120VAC (must use with rectified connector)			<input type="radio"/> BC Flying leads with light
<input type="radio"/> XX Other Options			<input type="radio"/> HA Plug-in connector with rectifier and light
			<input type="radio"/> XX Other Options

HOW TO ORDER CIRCUIT BAR (REGULATORS ORDERED SEPARATELY)**

EBM37A-00xxx-xx

Port size	Side cylinder ports (18 mm)	Bottom cylinder ports (18 mm)
1/8" NPTF	<input type="radio"/> EBM37A-00FAA-xx	<input type="radio"/> EBM37A-00GAA-xx
1/4" NPTF	<input type="radio"/> EBM37A-00FAB-xx	<input type="radio"/> EBM37A-00GAB-xx
6 mm tube receptacle	<input type="radio"/> EBM37A-00FAG-xx	<input type="radio"/> EBM37A-00GAG-xx

Number of stations (03=3 stations)

Note : clic for valves mounted on base at the factory, add - 9 to the model number.

** Pressure Regulators :

PR37A-GOAx

- X=A (0 to 120 PSI)
- X=B (0 to 80 PSI)
- X=C (0 to 30 PSI)

**TECHNICAL
DATA**

Fluid :	Compressed air, vacuum, inert gases
Pressure range :	Vacuum to 120 PSI
Lubrication :	Not required, if used select a medium aniline point lubricant (between 180°F and 210°F)
Filtration :	40 µ
Temperature range :	0°F to 120°F (-18°C to 50°C)
Orifice :	4.3 mm
Flow (at 6 bar, ΔP=1bar) :	5.2 W : 0.50C _v , 2.4 W : 0.25C _v , 1.8 W : 0.15C _v
Coil :	General purpose class A, continuous duty, encapsulated
Voltage range :	-15% to +10% of nominal voltage
Power :	5.2 W - 2.4 W - 1.8 W - 1.0 W
Response times :	Energize : 17.0 ms
(with 5.2 W coil)	De-energize : 6.0 ms

- Note : • Valve and coil are not interchangeable.
- Spare parts : • Seal between valve and bar : 16630. • Mounting screw (x2) : 35043. • Blanking plate : M-37001.
• Regulator blanking plate : R-47003.
- Options : • Isolation of inlet and/or exhaust. Special bar. Consult factory. • BSPP Threads.

DIMENSIONS

Number of stations	2	3	4	5	6	7	8	9	10	11
"A"	63.7	81.7	99.7	117.7	135.7	153.7	171.7	189.7	207.7	225.7

Dimensions are based on 18 mm centerline spacing

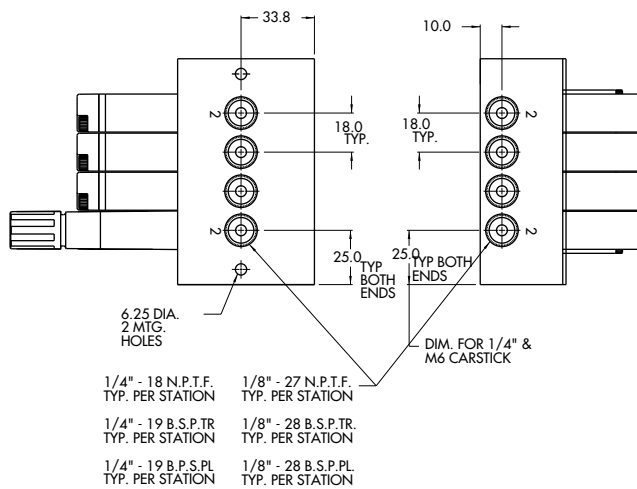

Dim.	Regulator with locking adjusting screw	Regulator with adjusting screw	Regulator with adjusting knob
"E"	135.8	131.8	139.6

* M6 Carstick available only on side port

Note: Bottom & side cylinder ports not available on the same station

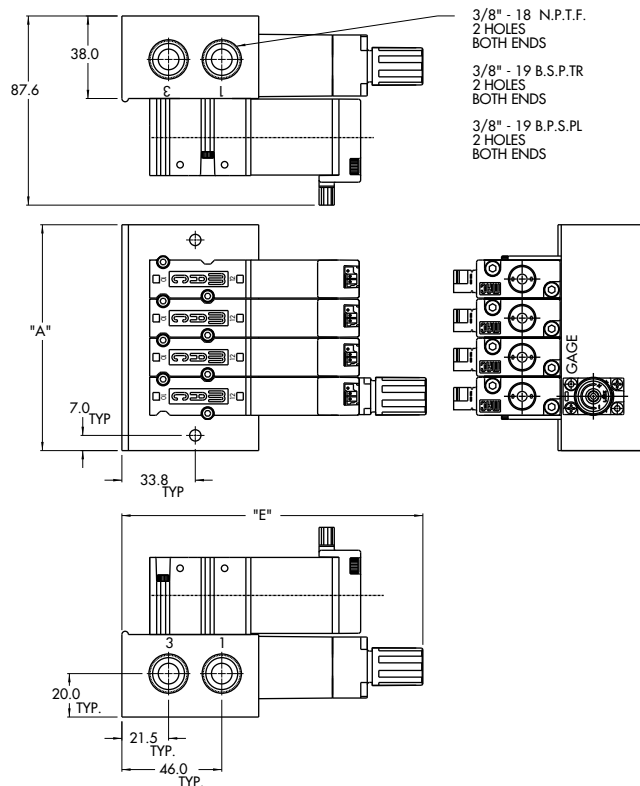

Function	Port size	Flow [Max]	Circuit bar mounting	Profile
3/2 NO-NC	1/8" - 1/4" 6 mm tube receptacle	0.5C_v	non plug-in add-on style cylinder ports in base	38 mm

OPERATIONAL BENEFITS

1. Direct solenoid operated valve.
2. Balanced poppet, immune to variations of pressure.
3. Short stroke with high flow.
4. The patented solenoid develops high shifting forces.
5. Powerful return spring.
6. Manual operator standard on all valves.

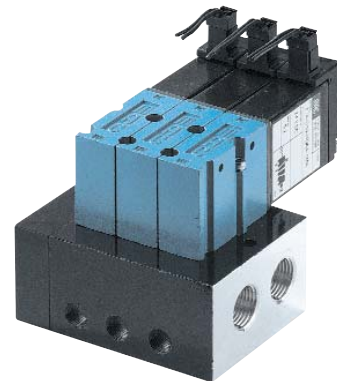

Reset

HOW TO ORDER

37A-xxx-Hxxx-xxx

HOW TO ORDER VALVE FOR CIRCUIT BAR MOUNTING

Port size (see base)	Universal valve	NC only valve
Valve less base	<input type="radio"/> 37A-C1O-Hxxx-xxx	<input type="radio"/> 37A-D1O-Hxxx-xxx

SOLENOID OPERATOR >

H xx x- x xx'

Voltage	Wire length	Manual operator	Electrical connection
<input type="radio"/> DC 24VDC (1.8 W)	<input type="radio"/> A 18"	<input type="radio"/> I Non-locking	<input type="radio"/> MA Plug-in wire Assy
<input type="radio"/> DB 24VDC (2.4 W)	<input type="radio"/> C 36"		<input type="radio"/> MC Plug-in wire Assy with light
<input type="radio"/> DA 24VDC (5.2 W)	<input type="radio"/> X Other Options		<input type="radio"/> BA Flying leads
<input type="radio"/> AA 120VAC (must use with rectified connector)			<input type="radio"/> BC Flying leads with light
<input type="radio"/> XX Other Options			<input type="radio"/> HA Plug-in connector with rectifier and light
			<input type="radio"/> XX Other Options

EBM37A-00xxx-xx

HOW TO ORDER CIRCUIT BAR

Port size	Side cylinder ports (18 mm)	Bottom cylinder ports (18 mm)
1/8" NPTF	<input type="radio"/> EBM37A-00DBA-xx	<input type="radio"/> EBM37A-00EBA-xx
1/4" NPTF	<input type="radio"/> EBM37A-00DBB-xx	<input type="radio"/> EBM37A-00EBB-xx
6 mm tube receptacle	<input type="radio"/> EBM37A-00DBG-xx	<input type="radio"/> EBM37A-00EBG-xx

Number of stations (03=3 stations)

Note: clic for valves mounted on base at the factory, add - 9 to the model number.
add-a-unit stations may be added to above bars. Clic here for model numbers.

**TECHNICAL
DATA**

Fluid :	Compressed air, vacuum, inert gases
Pressure range :	Vacuum to 120 PSI
Lubrication :	Not required, if used select a medium aniline point lubricant (between 180°F and 210°F)
Filtration :	40 µ
Temperature range :	0°F to 120°F (-18°C to 50°C)
Orifice :	4.3 mm
Flow (at 6 bar, ΔP=1bar) :	5.2 W : 0.50C _v , 2.4 W : 0.25C _v , 1.8 W : 0.15C _v
Coil :	General purpose class A, continuous duty, encapsulated
Voltage range :	-15% to +10% of nominal voltage
Power :	5.2 W - 2.4 W - 1.8 W - 1.0 W
Response times :	Energize : 17.0 ms
(with 5.2 W coil)	De-energize : 6.0 ms

- Note : • Valve and coil are not interchangeable.
- Spare parts : • Seal between valve and bar : 16630. • Mounting screw (x2) : 35043. • Blanking plate : M-37001. • End plate Kit : M-37005-0
- Options : • Isolation of inlet and/or exhaust. Special bar. Consult factory. • BSPP Threads.

DIMENSIONS

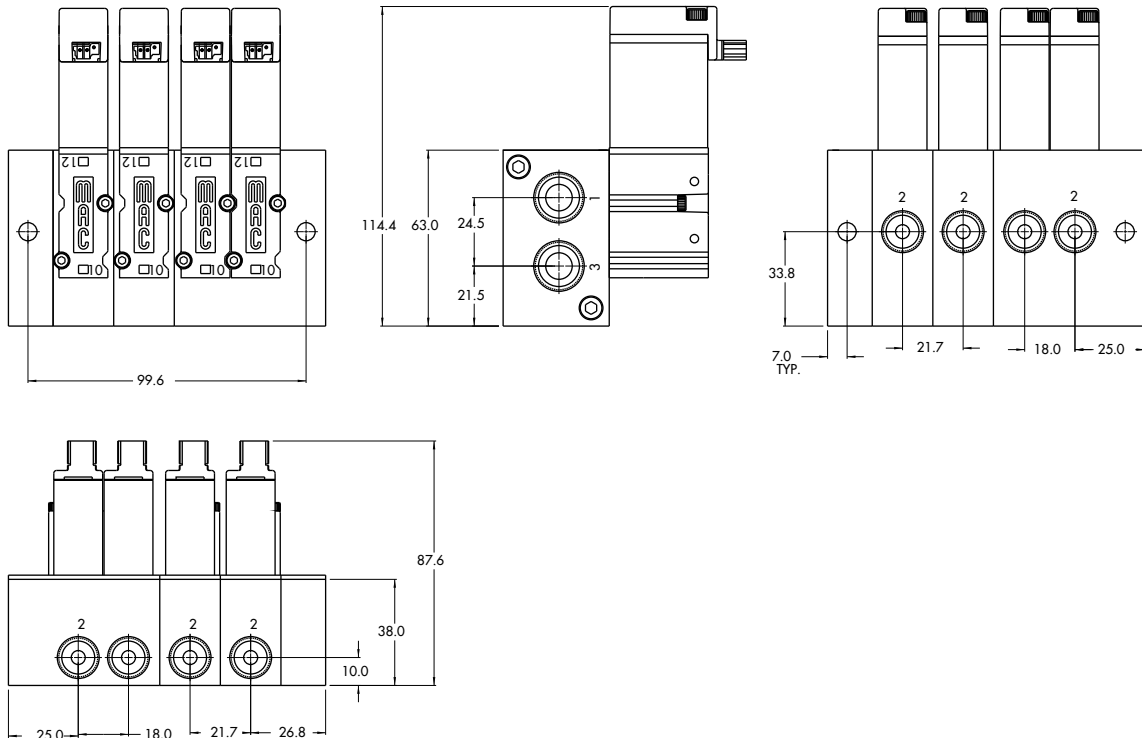

Note: Bottom & side cylinder ports not available on the same station

Function	Port size	Flow [Max]	Circuit bar mounting	Profile
3/2 NO-NC	1/8" - 1/4" 6 mm tube receptacle	0.5C_v	non plug-in odd-a-unit stations	38 mm

OPERATIONAL BENEFITS

1. Direct solenoid operated valve.
2. Balanced poppet, immune to variations of pressure.
3. Short stroke with high flow.
4. The patented solenoid develops high shifting forces.
5. Powerful return spring.
6. Manual operator standard on all valves.

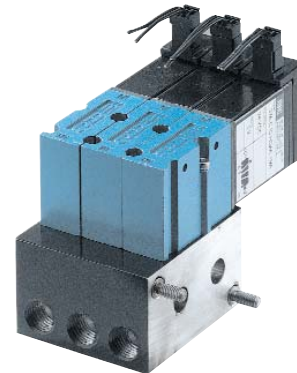

Reset

HOW TO ORDER

37A-xxx-Hxxx-xxx

HOW TO ORDER VALVE FOR CIRCUIT BAR MOUNTING

Port size (see base)	Universal valve	NC only valve
Valve less base	<input type="radio"/> 37A-C1O-Hxxx-xxx	<input type="radio"/> 37A-D1O-Hxxx-xxx

SOLENOID OPERATOR >

H **xx x-x xx'**

Voltage	Wire length	Manual operator	Electrical connection
<input type="radio"/> DC 24VDC (1.8 W)	<input type="radio"/> A 18"	<input type="radio"/> I Non-locking	<input type="radio"/> MA Plug-in wire Assy
<input type="radio"/> DB 24VDC (2.4 W)	<input type="radio"/> c 36"		<input type="radio"/> MC Plug-in wire Assy with light
<input type="radio"/> DA 24VDC (5.2 W)	<input type="radio"/> x Other Options		<input type="radio"/> BA Flying leads
<input type="radio"/> AA 120VAC (must use with rectified connector)			<input type="radio"/> BC Flying leads with light
<input type="radio"/> xx Other Options			<input type="radio"/> HA Plug-in connector with rectifier and light
			<input type="radio"/> xx Other Options

EBM37A-00xxx-xx

HOW TO ORDER CIRCUIT BAR

Port size	Side cylinder ports (18 mm)	Bottom cylinder ports (18 mm)
1/8" NPTF	<input type="radio"/> EBM37A-00DCA-xx	<input type="radio"/> EBM37A-00ECA-xx
1/4" NPTF	<input type="radio"/> EBM37A-00DCB-xx	<input type="radio"/> EBM37A-00ECB-xx
6 mm tube receptacle	<input type="radio"/> EBM37A-00DCG-xx	<input type="radio"/> EBM37A-00ECG-xx

Number of stations (01, 02, 03 or 04)

Note : clic for valves mounted on base at the factory, add - 9 to the model number.

**T E C H N I C A L
D A T A**

Fluid :	Compressed air, vacuum, inert gases
Pressure range :	Vacuum to 120 PSI
Lubrication :	Not required, if used select a medium aniline point lubricant (between 180°F and 210°F)
Filtration :	40 µ
Temperature range :	0°F to 120°F (-18°C to 50°C)
Orifice :	4.3 mm
Flow (at 6 bar, ΔP=1bar) :	5.2 W : 0.50C _v , 2.4 W : 0.25C _v , 1.8 W : 0.15C _v
Coil :	General purpose class A, continuous duty, encapsulated
Voltage range :	-15% to +10% of nominal voltage
Power :	5.2 W - 2.4 W - 1.8 W - 1.0 W
Response times :	Energize : 17.0 ms
(with 5.2 W coil)	De-energize : 6.0 ms

- Note :
 - Valve and coil are not interchangeable.
- Spare parts :
 - Seal between valve and bar : 16630. • Mounting screw (x2) : 35043. • Blanking plate : M-37001.
 - O-ring port seal (x2) : 17015-01. • Tie rod (x2) : 79007-01 (one station length)
- Options :
 - Isolation of inlet and/or exhaust. Special bar. Consult factory. • BSPP Threads.

D I M E N S I O N S

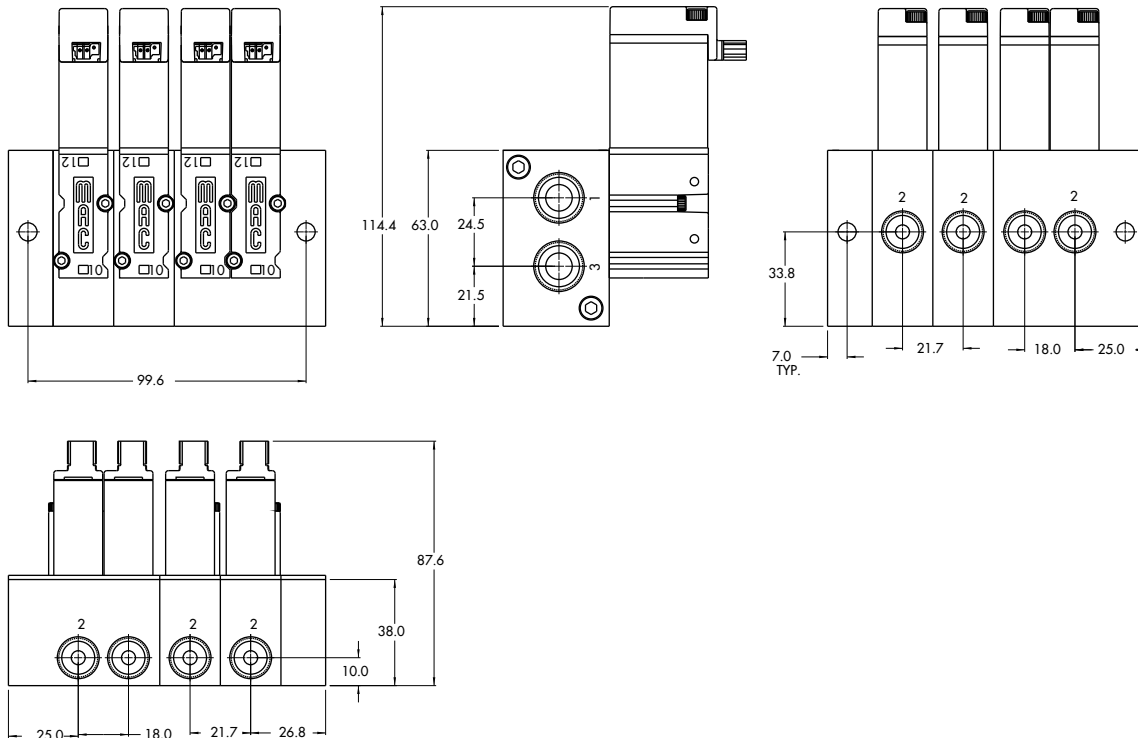

Note: Bottom & side cylinder ports not available on the same station

Function	Port size	Flow [Max]	Circuit bar mounting	Profile
3/2 NO-NC	1/8" - 1/4" 6 mm tube receptacle	0.5C_v	plug-in	32.5 mm

OPERATIONAL BENEFITS

1. Direct solenoid operated valve.
2. Balanced poppet, immune to variations of pressure.
3. Short stroke with high flow.
4. The patented solenoid develops high shifting forces.
5. Powerful return spring.
6. Manual operator standard on all valves.

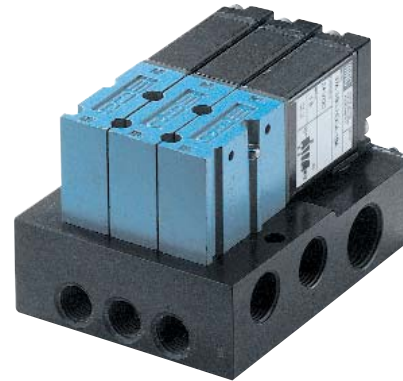

Reset

HOW TO ORDER

37A-xxx-HxxP-xxx

HOW TO ORDER VALVE FOR CIRCUIT BAR MOUNTING

Port size (see base)	Universal valve	NC only valve
Valve less base	<input type="radio"/> 37A-C1O-HxxP-xxx	<input type="radio"/> 37A-D1O-HxxP-xxx

SOLENOID OPERATOR >

H XX P- X XX'

XX Voltage	X Manual operator	XX Electrical connection
<input type="radio"/> DC 24VDC (1.8 W)	<input type="radio"/> 1 Non-locking	<input type="radio"/> FA Plug-in
<input type="radio"/> DB 24VDC (2.4 W)		<input type="radio"/> FC Plug-in with light
<input type="radio"/> DA 24VDC (5.2 W)		<input type="radio"/> FE Plug-in with suppression diode
<input type="radio"/> AA 120VAC (Mod. No. required see below)		<input type="radio"/> FG Plug-in with suppression diode with LED light
<input type="radio"/> xx Other Options		<input type="radio"/> xx Other Options

HOW TO ORDER "PLUG-IN" CIRCUIT BAR**

ECD37A-xxxxx-xxxx

Port size	Spacing mm	Side cylinder ports	Bottom cylinder ports
1/8" NPTF	18	<input type="radio"/> ECD37A-00AAA-A0xx	<input type="radio"/> ECD37A-00BAA-A0xx
1/4" NPTF	18	<input type="radio"/> ECD37A-00AAB-A0xx	<input type="radio"/> ECD37A-00BAB-A0xx
6 mm tube receptacle	18	<input type="radio"/> ECD37A-00AAG-A0xx	<input type="radio"/> ECD37A-00BAG-A0xx
1/8" NPTF	30	<input type="radio"/> ECD37A-01AAA-C0xx	<input type="radio"/> ECD37A-01BAA-C0xx
1/4" NPTF	30	<input type="radio"/> ECD37A-01AAB-C0xx	<input type="radio"/> ECD37A-01BAB-C0xx
6 mm tube receptacle	30	<input type="radio"/> ECD37A-01AAG-C0xx	<input type="radio"/> ECD37A-01BAG-C0xx

Number of stations (03=3 stations)
 Note : clic for valves mounted on base at the factory, add - 9 to the model number.
 clic for multi-pin connector (9, 15 or 25).
 for AC voltage use mod. FWR2 after circuit bar model number.

- A0 = without light
- AA = with light (120V)
- AB = with light (240V)
- AD = with light (24V)
- C0 = terminal strip

**T E C H N I C A L
D A T A**

Fluid :	Compressed air, vacuum, inert gases
Pressure range :	Vacuum to 120 PSI
Lubrication :	Not required, if used select a medium aniline point lubricant (between 180°F and 210°F)
Filtration :	40 µ
Temperature range :	0°F to 120°F (-18°C to 50°C)
Orifice :	4.3 mm
Flow (at 6 bar, ΔP=1bar) :	5.2 W : 0.50C _v , 2.4 W : 0.25C _v , 1.8 W : 0.15C _v
Coil :	General purpose class A, continuous duty, encapsulated
Voltage range :	-15% to +10% of nominal voltage
Power :	5.2 W - 2.4 W - 1.8 W - 1.0 W
Response times :	Energize : 17.0 ms
(with 5.2 W coil)	De-energize : 6.0 ms

- Note : • Valve and coil are not interchangeable.
- Spare parts : • Seal between valve and bar : 16630. • Mounting screw (x2) : 35043. • Blanking plate : M-37001.
• Base wire plug-in protector : 16520.
- Options : • Isolation of inlet and/or exhaust. Special bar. Consult factory. • BSPP Threads.

D I M E N S I O N S

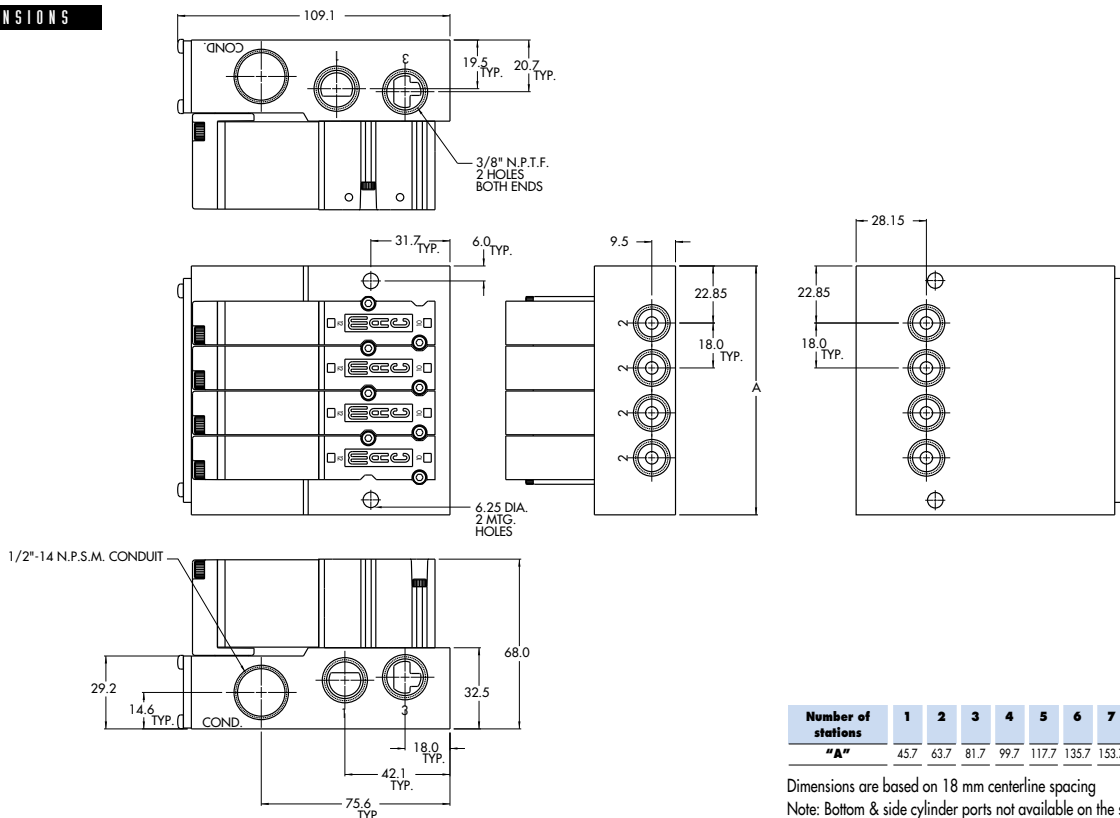

Number of stations	1	2	3	4	5	6	7	8	9	10
"A"	45.7	63.7	81.7	99.7	117.7	135.7	153.7	171.7	189.7	207.7

Dimensions are based on 18 mm centerline spacing
Note: Bottom & side cylinder ports not available on the same station

Function	Port size	Flow [Max]	Circuit bar mounting	Profile
3/2 NO-NC	1/8" - 1/4"	0.5C_v	plug-in with Pr. Reg.	44 mm

OPERATIONAL BENEFITS

1. Direct solenoid operated valve.
2. Balanced poppet, immune to variations of pressure.
3. Short stroke with high flow.
4. The patented solenoid develops high shifting forces.
5. Powerful return spring.
6. Manual operator standard on all valves.

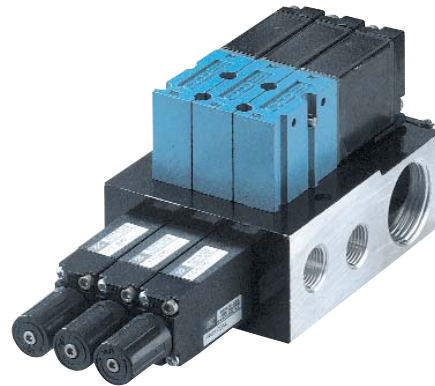

HOW TO ORDER

37A-xxx-HxxxP-xxx

HOW TO ORDER VALVE FOR CIRCUIT BAR MOUNTING

Port size (see base)	Universal valve	NC only valve
Valve less base	<input type="radio"/> 37A-C1O-HxxxP-xxx	<input type="radio"/> 37A-D1O-HxxxP-xxx

SOLENOID OPERATOR >

H XX P- X XX*

XX Voltage	X Manual operator	XX Electrical connection
<input type="radio"/> DC 24VDC (1.8 W)	<input type="radio"/> 1 Non-locking	<input type="radio"/> FA Plug-in
<input type="radio"/> DB 24VDC (2.4 W)		<input type="radio"/> FC Plug-in with light
<input type="radio"/> DA 24VDC (5.2 W)		<input type="radio"/> FE Plug-in with suppression diode
<input type="radio"/> AA 120VAC (Mod. No. required see below)		<input type="radio"/> FG Plug-in with suppression diode with LED light
<input type="radio"/> xx Other Options		<input type="radio"/> xx Other Options

HOW TO ORDER "PLUG-IN" CIRCUIT BAR (REGULATORS ORDERED SEPARATELY)**

ECD37A-xxxxx-xxxx

Port size	Spacing mm	Bottom cylinder ports
1/8" NPTF	18	<input type="radio"/> ECD37A-00CDA-A0xx
1/4" NPTF	18	<input type="radio"/> ECD37A-00CDB-A0xx
1/8" NPTF	30	<input type="radio"/> ECD37A-01CDA-C0xx
1/4" NPTF	30	<input type="radio"/> ECD37A-01CDB-C0xx

Number of stations (03=3 stations)

** Other options available, consult factory.

Note : clic for valves mounted on base at the factory, add - 9 to the model number.

clic for multi-pin connector (9, 15 or 25).

for AC voltage use mod. FWR2 after circuit bar model number.

** Pressure Regulators :

PR37A-GOAx

X=A (0 to 120 PSI)

X=B (0 to 80 PSI)

X=C (0 to 30 PSI)

A0 = without light

AA = with light (120V)

AB = with light (240V)

AD = with light (24V)

C0 = terminal strip

CA = terminal strip with light (120V)

CB = terminal strip with light (240V)

CD = terminal strip with light (24V)

**TECHNICAL
DATA**

Fluid :	Compressed air, vacuum, inert gases
Pressure range :	Vacuum to 120 PSI
Lubrication :	Not required, if used select a medium aniline point lubricant (between 180°F and 210°F)
Filtration :	40 µ
Temperature range :	0°F to 120°F (-18°C to 50°C)
Orifice :	4.3 mm
Flow (at 6 bar, ΔP=1bar) :	5.2 W : 0.50C _v , 2.4 W : 0.25C _v , 1.8 W : 0.15C _v
Coil :	General purpose class A, continuous duty, encapsulated
Voltage range :	-15% to +10% of nominal voltage
Power :	5.2 W - 2.4 W - 1.8 W - 1.0 W
Response times :	Energize : 17.0 ms
(with 5.2 W coil)	De-energize : 6.0 ms

- Note : • Valve and coil are not interchangeable.
- Spare parts : • Seal between valve and bar : 16630. • Mounting screw (x2) : 35043. • Blanking plate : M-37001.
• Base wire plug-in protector : 16520. • Regulator blanking plate : R-47003.
- Options : • Isolation of inlet and/or exhaust. Special bar. Consult factory. • BSPP Threads.

DIMENSIONS

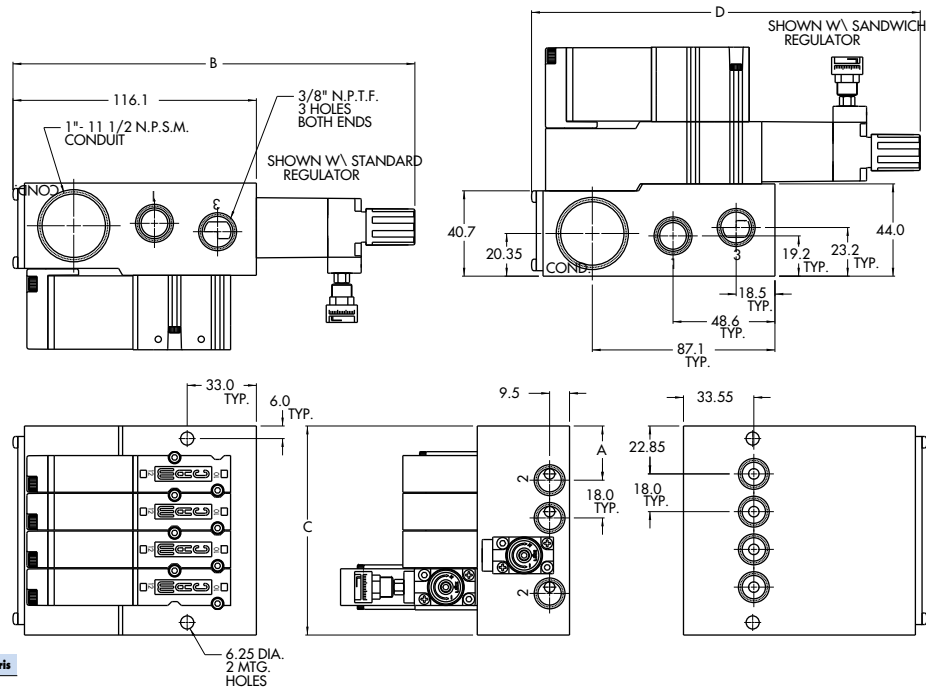

Dim.	1/4"	1/8"	6 mm Legris
"A"	25.85	25.85	22.85

Dim.	Regulator with locking adjusting screw	Regulator with adjusting screw	Regulator with adjusting knob
"B"	188.8	184.7	191.7
"D"	182.5	178.4	185.4

Number of stations	1	2	3	4	5	6	7	8	9	10
"C"	45.7	63.7	81.7	99.7	117.7	135.7	153.7	171.7	189.7	207.7

Dimensions are based on 18 mm centerline spacing
Note: Bottom & side cylinder ports not available on the same station

Function	Port size	Flow [Max]	Circuit bar mounting	Profile
3/2 NO-NC	1/8" - 1/4" 6 mm tube receptacle	0.5C_v	add-on style plug-in	44 mm

OPERATIONAL BENEFITS

1. Direct solenoid operated valve.
2. Balanced poppet, immune to variations of pressure.
3. Short stroke with high flow.
4. The patented solenoid develops high shifting forces.
5. Powerful return spring.
6. Manual operator standard on all valves.



HOW TO ORDER

37A-xxx-HxxP-xxx

HOW TO ORDER VALVE FOR CIRCUIT BAR MOUNTING

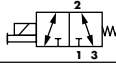
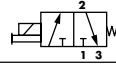
Port size (see base)	Universal valve	NC only valve
		
Valve less base	<input type="radio"/> 37A-C1O-HxxP-xxx	<input type="radio"/> 37A-D1O-HxxP-xxx

SOLENOID OPERATOR >

H **XX** P- **X** **XX**

XX Voltage	X Manual operator	XX Electrical connection
<input type="radio"/> DC 24VDC (1.8 W)	<input type="radio"/> 1 Non-locking	<input type="radio"/> FA Plug-in
<input type="radio"/> DB 24VDC (2.4 W)		<input type="radio"/> FC Plug-in with light
<input type="radio"/> DA 24VDC (5.2 W)		<input type="radio"/> FE Plug-in with suppression diode
<input type="radio"/> AA 120VAC (Mod. No. required see below)		<input type="radio"/> FG Plug-in with suppression diode with LED light
<input type="radio"/> xx Other Options		<input type="radio"/> xx Other Options

HOW TO ORDER "PLUG-IN" CIRCUIT BAR**

ECD37A-xxxxx-xxxx

Port size	Spacing mm	Side cylinder ports	Bottom cylinder ports
1/8" NPTF	18	<input type="radio"/> ECD37A-00AEA-A0xx	<input type="radio"/> ECD37A-00BEA-A0xx
1/4" NPTF	18	<input type="radio"/> ECD37A-00AEB-A0xx	<input type="radio"/> ECD37A-00BEB-A0xx
6 mm tube receptacle	18	<input type="radio"/> ECD37A-00AEG-A0xx	<input type="radio"/> ECD37A-00BEG-A0xx
1/8" NPTF	30	<input type="radio"/> ECD37A-01AEA-C0xx	<input type="radio"/> ECD37A-01BEA-C0xx
1/4" NPTF	30	<input type="radio"/> ECD37A-01AEB-C0xx	<input type="radio"/> ECD37A-01BEB-C0xx
6 mm tube receptacle	30	<input type="radio"/> ECD37A-01AEG-C0xx	<input type="radio"/> ECD37A-01BEG-C0xx

Number of stations (03=3 stations)

** Other options available, consult factory.

Note : clic for valves mounted on base at the factory, add - 9 to the model number.
 clic for multi-pin connector (9, 15 or 25).

for AC voltage use mod. FWR2 after circuit bar model number.

add-a-unit stations may be added to above bars. Clic here for model numbers.

- A0 = without light
- AA = with light (120V)
- AB = with light (240V)
- AD = with light (24V)
- C0 = terminal strip
- CA = terminal strip with light (120V)
- CB = terminal strip with light (240V)
- CD = terminal strip with light (24V)

**TECHNICAL
DATA**

Fluid :	Compressed air, vacuum, inert gases
Pressure range :	Vacuum to 120 PSI
Lubrication :	Not required, if used select a medium aniline point lubricant (between 180°F and 210°F)
Filtration :	40 µ
Temperature range :	0°F to 120°F (-18°C to 50°C)
Orifice :	4.3 mm
Flow (at 6 bar, ΔP=1bar) :	5.2 W : 0.50C _v , 2.4 W : 0.25C _v , 1.8 W : 0.15C _v
Coil :	General purpose class A, continuous duty, encapsulated
Voltage range :	-15% to +10% of nominal voltage
Power :	5.2 W - 2.4 W - 1.8 W - 1.0 W
Response times :	Energize : 17.0 ms
(with 5.2 W coil)	De-energize : 6.0 ms

- Note : • Valve and coil are not interchangeable.
- Spare parts : • Seal between valve and bar : 16630. • Mounting screw (x2) : 35043. • Blanking plate : M-37001. • End plate kit : M-37003-01
- Options : • Base wire plug-in protector : 16520. • Isolator disc between add-a-units : 28438. • Isolation of inlet and/or exhaust. Special bar. Consult factory. • BSPP Threads.

DIMENSIONS

Number of stations	1	2	3	4	5	6	7	8	9	10
"C" w/regulator	-	53.6	71.6	89.6	107.6	125.6	143.6	161.6	179.6	197.6
"C" w/o regulator	-	51.85	69.85	87.85	105.85	123.85	141.85	159.85	177.85	195.85
"D"	21.7	39.7	57.7	75.7	-	-	-	-	-	-

Dimensions are based on 18 mm centerline spacing
 Note: Bottom & side cylinder ports not available on the same station

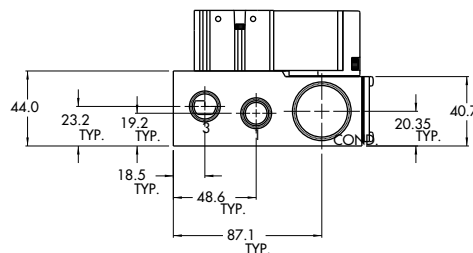
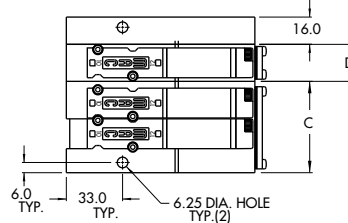
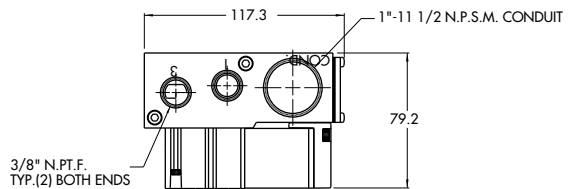
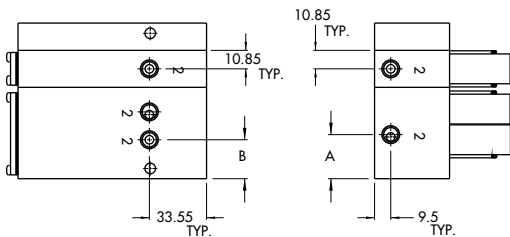

Dim.	1/8"	1/4"	6 mm Legris	1/8" w/regulator	1/4" w/regulator
"A"	22.65	24.20	22.85	-	-
"B"	22.85	22.85	25.85	21.20	22.60

Function	Port size	Flow [Max]	Circuit bar mounting	Profile
3/2 NO-NC	1/8" - 1/4"	0.5C_v	add-on style plug in with Pr. Reg.	44 mm

OPERATIONAL BENEFITS

1. Direct solenoid operated valve.
2. Balanced poppet, immune to variations of pressure.
3. Short stroke with high flow.
4. The patented solenoid develops high shifting forces.
5. Powerful return spring.
6. Manual operator standard on all valves.



HOW TO ORDER

37A-xxx-HxxP-xxx

HOW TO ORDER VALVE FOR CIRCUIT BAR MOUNTING

Port size (see base)	Universal valve	NC only valve
Valve less base	<input type="radio"/> 37A-C1O-HxxP-xxx	<input type="radio"/> 37A-D1O-HxxP-xxx

SOLENOID OPERATOR >

H XX P- X XX*

XX Voltage	X Manual operator	XX Electrical connection
<input type="radio"/> DC 24VDC (1.8 W)	<input type="radio"/> 1 Non-locking	<input type="radio"/> FA Plug-in
<input type="radio"/> DB 24VDC (2.4 W)		<input type="radio"/> FC Plug-in with light
<input type="radio"/> DA 24VDC (5.2 W)		<input type="radio"/> FE Plug-in with suppression diode
<input type="radio"/> AA 120VAC (Mod. No. required see below)		<input type="radio"/> FG Plug-in with suppression diode with LED light
<input type="radio"/> xx Other Options		<input type="radio"/> xx Other Options

HOW TO ORDER "PLUG-IN" CIRCUIT BAR (REGULATORS ORDERED SEPARATELY)**

ECD37A-xxxxxx-xxxx

Port size	Spacing mm	Bottom cylinder ports
1/8" NPTF	18	<input type="radio"/> ECD37A-00CEA-A0xx
1/4" NPTF	18	<input type="radio"/> ECD37A-00CEB-A0xx
1/8" NPTF	30	<input type="radio"/> ECD37A-01CEA-C0xx
1/4" NPTF	30	<input type="radio"/> ECD37A-01CEB-C0xx

Number of stations (03=3 stations)

** Other options available, consult factory.

Note : clic for valves mounted on base at the factory, add - 9 to the model number.
 clic for multi-pin connector (9, 15 or 25).
 for AC voltage use mod. FWR2 after circuit bar model number.
 add-a-unit stations may be added to above bars. Click here for model numbers.

** Pressure Regulators :

PR37A-GOAx

- X=A (0 to 120 PSI)
- X=B (0 to 80 PSI)
- X=C (0 to 30 PSI)

- A0 = without light
- AA = with light (120V)
- AB = with light (240V)
- AD = with light (24V)
- C0 = terminal strip
- CA = terminal strip with light (120V)
- CB = terminal strip with light (240V)
- CD = terminal strip with light (24V)

**TECHNICAL
DATA**

Fluid :	Compressed air, vacuum, inert gases
Pressure range :	Vacuum to 120 PSI
Lubrication :	Not required, if used select a medium aniline point lubricant (between 180°F and 210°F)
Filtration :	40 µ
Temperature range :	0°F to 120°F (-18°C to 50°C)
Orifice :	4.3 mm
Flow (at 6 bar, ΔP=1bar) :	5.2 W : 0.50C _v , 2.4 W : 0.25C _v , 1.8 W : 0.15C _v
Coil :	General purpose class A, continuous duty, encapsulated
Voltage range :	-15% to +10% of nominal voltage
Power :	5.2 W - 2.4 W - 1.8 W - 1.0 W
Response times :	Energize : 17.0 ms
(with 5.2 W coil)	De-energize : 6.0 ms

- Note : • Valve and coil are not interchangeable.
- Spare parts : • Seal between valve and bar : 16630. • Mounting screw (x2) : 35043. • Blanking plate : M-37001. • End plate kit : M-37003-01
- Options : • Base wire plug-in protector : 16520. • Isolator disc between add-a-units : 28438. • Isolation of inlet and/or exhaust. Special bar. Consult factory. • BSPP Threads.

DIMENSIONS

Number of stations	1	2	3	4	5	6	7	8	9	10
"C" w/regulator	-	53.6	71.6	89.6	107.6	125.6	143.6	161.6	179.6	197.6
"C" w/o regulator	-	51.85	69.85	87.85	105.85	123.85	141.85	159.85	177.85	195.85
"D"	21.7	39.7	57.7	75.7	-	-	-	-	-	-

Dimensions are based on 18 mm centerline spacing
Note: Bottom & side cylinder ports not available on the same station

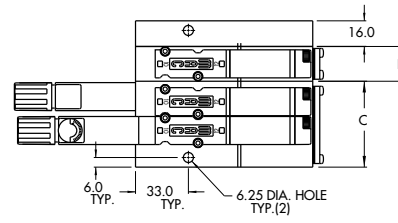
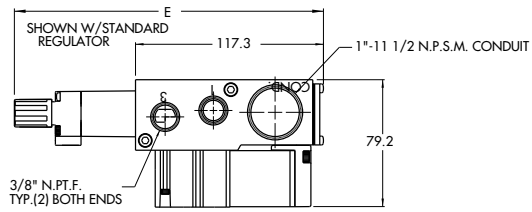
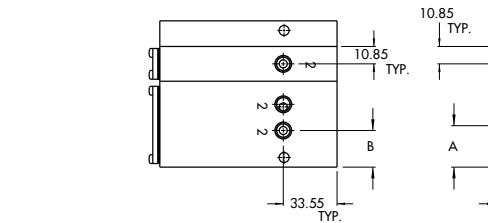

Dim.	1/8"	1/4"	6 mm Legris	1/8" w/regulator	1/4" w/regulator
"A"	22.65	24.20	22.85	-	-
"B"	22.85	22.85	25.85	21.20	22.60

Dim.	Regulator with locking adjusting screw	Regulator with adjusting screw	Regulator with adjusting knob
"E"	188.8	184.7	191.7
"F"	182.5	178.4	185.4

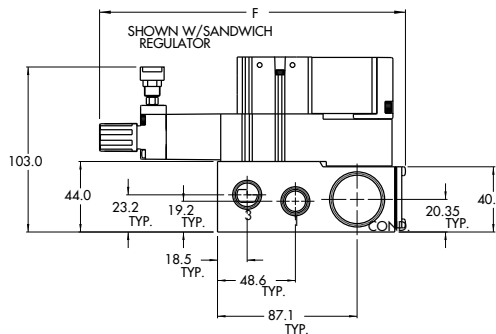

Function	Port size	Flow [Max]	Circuit bar mounting	Profile
3/2 NO-NC	1/8" - 1/4" 6 mm tube receptacle	0.5C_v	plug-in add-a-unit stations	44 mm

OPERATIONAL BENEFITS

1. Direct solenoid operated valve.
2. Balanced poppet, immune to variations of pressure.
3. Short stroke with high flow.
4. The patented solenoid develops high shifting forces.
5. Powerful return spring.
6. Manual operator standard on all valves.



HOW TO ORDER

37A-xxx-HxxP-xxx

HOW TO ORDER VALVE FOR CIRCUIT BAR MOUNTING

Port size (see base)	Universal valve	NC only valve
Valve less base	<input type="radio"/> 37A-C1O-HxxP-xxx	<input type="radio"/> 37A-D1O-HxxP-xxx

SOLENOID OPERATOR >

H XX P- X XX*

XX Voltage	X Manual operator	XX Electrical connection
<input type="radio"/> DC 24VDC (1.8 W)	<input type="radio"/> 1 Non-locking	<input type="radio"/> FA Plug-in
<input type="radio"/> DB 24VDC (2.4 W)		<input type="radio"/> FC Plug-in with light
<input type="radio"/> DA 24VDC (5.2 W)		<input type="radio"/> FE Plug-in with suppression diode
<input type="radio"/> AA 120VAC (Mod. No. required see below)		<input type="radio"/> FG Plug-in with suppression diode with LED light
<input type="radio"/> xx Other Options		<input type="radio"/> xx Other Options

HOW TO ORDER "PLUG-IN" CIRCUIT BAR**

ECD37A-xxxxx-xxxx

Port size	Spacing mm	Side cylinder ports	Bottom cylinder ports
1/8" NPTF	18	<input type="radio"/> ECD37A-00AFA-A0xx	<input type="radio"/> ECD37A-00BFA-A0xx
1/4" NPTF	18	<input type="radio"/> ECD37A-00AFB-A0xx	<input type="radio"/> ECD37A-00BFB-A0xx
6 mm tube receptacle	18	<input type="radio"/> ECD37A-00AFG-A0xx	<input type="radio"/> ECD37A-00BFG-A0xx
1/8" NPTF	30	<input type="radio"/> ECD37A-01AFA-C0xx	<input type="radio"/> ECD37A-01BFA-C0xx
1/4" NPTF	30	<input type="radio"/> ECD37A-01AFB-C0xx	<input type="radio"/> ECD37A-01BFB-C0xx
6 mm tube receptacle	30	<input type="radio"/> ECD37A-01AFG-C0xx	<input type="radio"/> ECD37A-01BFG-C0xx

Number of stations (03=3 stations) - maximum length is 4 stations.

** Other options available, consult factory.

Note : clic for valves mounted on base at the factory, add - 9 to the model number.
for AC voltage use mod. FWR2 after circuit bar model number.
when add-a-unit stations are added to bars with a multi-pin connector, mod SD03 should be included with add-a-unit model number.

- A0 = without light
- AA = with light (120V)
- AB = with light (240V)
- AD = with light (24V)
- C0 = terminal strip
- CA = terminal strip with light (120V)
- CB = terminal strip with light (240V)
- CD = terminal strip with light (24V)

**TECHNICAL
DATA**

Fluid :	Compressed air, vacuum, inert gases
Pressure range :	Vacuum to 120 PSI
Lubrication :	Not required, if used select a medium aniline point lubricant (between 180°F and 210°F)
Filtration :	40 µ
Temperature range :	0°F to 120°F (-18°C to 50°C)
Orifice :	4.3 mm
Flow (at 6 bar, ΔP=1bar) :	5.2 W : 0.50C _v , 2.4 W : 0.25C _v , 1.8 W : 0.15C _v
Coil :	General purpose class A, continuous duty, encapsulated
Voltage range :	-15% to +10% of nominal voltage
Power :	5.2 W - 2.4 W - 1.8 W - 1.0 W
Response times :	Energize : 17.0 ms
(with 5.2 W coil)	De-energize : 6.0 ms

- Note : • Valve and coil are not interchangeable.
- Spare parts : • Seal between valve and bar : 16630. • Mounting screw (x2) : 35043. • Blanking plate : M-37001.
• O-ring port seal (x2) : 17015-01 • Tie rod (x2) : 79007-01 (one station length).
- Options : • Isolation of inlet and/or exhaust. Special bar. Consult factory. • BSPP Threads.

DIMENSIONS

Number of stations	1	2	3	4	5	6	7	8	9	10
"C" w/regulator	-	53.6	71.6	89.6	107.6	125.6	143.6	161.6	179.6	197.6
"C" w/o regulator	-	51.85	69.85	87.85	105.85	123.85	141.85	159.85	177.85	195.85
"D"	21.7	39.7	57.7	75.7	-	-	-	-	-	-

Dimensions are based on 18 mm centerline spacing
Note: Bottom & side cylinder ports not available on the same station

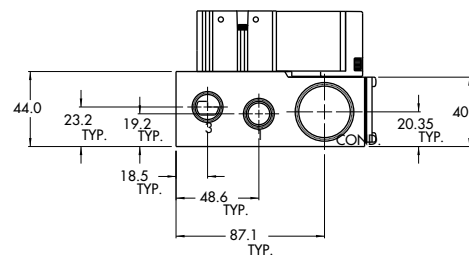
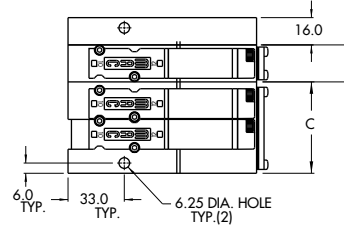
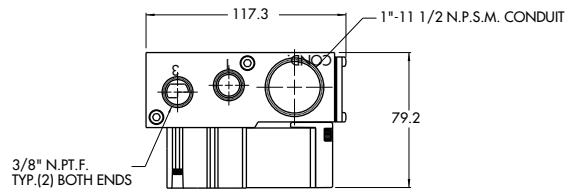
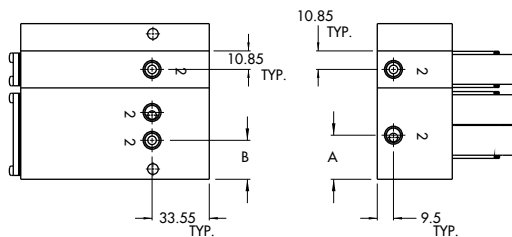

Dim.	1/8"	1/4"	6 mm Legris	1/8" w/regulator	1/4" w/regulator
"A"	22.65	24.20	22.85	-	-
"B"	22.85	22.85	25.85	21.20	22.60

Function	Port size	Flow [Max]	Circuit bar mounting	Profile
3/2 NO-NC	1/8" - 1/4"	0.5C_v	plug-in add-a-unit stations with Pr. Reg.	44 mm

OPERATIONAL BENEFITS

1. Direct solenoid operated valve.
2. Balanced poppet, immune to variations of pressure.
3. Short stroke with high flow.
4. The patented solenoid develops high shifting forces.
5. Powerful return spring.
6. Manual operator standard on all valves.



HOW TO ORDER

37A-xxx-HxxP-xxx

HOW TO ORDER VALVE FOR CIRCUIT BAR MOUNTING

Port size (see base)	Universal valve	NC only valve
Valve less base	<input type="radio"/> 37A-C1O-HxxP-xxx	<input type="radio"/> 37A-D1O-HxxP-xxx

SOLENOID OPERATOR >

H XX P- X XX*

XX Voltage	X Manual operator	XX Electrical connection
<input type="radio"/> DC 24VDC (1.8 W)	<input type="radio"/> 1 Non-locking	<input type="radio"/> FA Plug-in
<input type="radio"/> DB 24VDC (2.4 W)		<input type="radio"/> FC Plug-in with light
<input type="radio"/> DA 24VDC (5.2 W)		<input type="radio"/> FE Plug-in with suppression diode
<input type="radio"/> AA 120VAC (Mod. No. required see below)		<input type="radio"/> FG Plug-in with suppression diode with LED light
<input type="radio"/> xx Other Options		<input type="radio"/> xx Other Options

HOW TO ORDER "PLUG-IN" CIRCUIT BAR (REGULATORS ORDERED SEPARATELY)**

ECD37A-xxxxxx-xxxx

Port size	Spacing mm	Bottom cylinder ports
1/8" NPTF	18	<input type="radio"/> ECD37A-00CFA-A0xx
1/4" NPTF	18	<input type="radio"/> ECD37A-00CFB-A0xx
1/8" NPTF	30	<input type="radio"/> ECD37A-01CFA-C0xx
1/4" NPTF	30	<input type="radio"/> ECD37A-01CFB-C0xx

Number of stations (03=3 stations) - maximum length is 4 stations.

** Other options available, consult factory.

Note : clic for valves mounted on base at the factory, add - 9 to the model number.
for AC voltage use mod. FWR2 after circuit bar model number.
when add-a-unit stations are added to bars with a multi-pin connector, mod SD03 should be included with add-a-unit model number.

** Pressure Regulators :

PR37A-GOAx

- X=A (0 to 120 PSI)
- X=B (0 to 80 PSI)
- X=C (0 to 30 PSI)

- A0 = without light
- AA = with light (120V)
- AB = with light (240V)
- AD = with light (24V)
- C0 = terminal strip
- CA = terminal strip with light (120V)
- CB = terminal strip with light (240V)
- CD = terminal strip with light (24V)

**TECHNICAL
DATA**

Fluid :	Compressed air, vacuum, inert gases
Pressure range :	Vacuum to 120 PSI
Lubrication :	Not required, if used select a medium aniline point lubricant (between 180°F and 210°F)
Filtration :	40 µ
Temperature range :	0°F to 120°F (-18°C to 50°C)
Orifice :	4.3 mm
Flow (at 6 bar, ΔP=1bar) :	5.2 W : 0.50C _v , 2.4 W : 0.25C _v , 1.8 W : 0.15C _v
Coil :	General purpose class A, continuous duty, encapsulated
Voltage range :	-15% to +10% of nominal voltage
Power :	5.2 W - 2.4 W - 1.8 W - 1.0 W
Response times :	Energize : 17.0 ms
(with 5.2 W coil)	De-energize : 6.0 ms

Note : • Valve and coil are not interchangeable.

Spare parts : • Seal between valve and bar : 16630. • Mounting screw (x2) : 35043. • Blanking plate : M-37001.
• O-ring port seal (x2) : 17015-01 • Tie rod (x2) : 79007-01 (one station length). • Regulator blanking plate : R-47003.

Options : • Isolation of inlet and/or exhaust. Special bar. Consult factory. • BSPP Threads.

DIMENSIONS

Number of stations	1	2	3	4	5	6	7	8	9	10
"C" w/regulator	-	53.6	71.6	89.6	107.6	125.6	143.6	161.6	179.6	197.6
"C" w/o regulator	-	51.85	69.85	87.85	105.85	123.85	141.85	159.85	177.85	195.85
"D"	21.7	39.7	57.7	75.7	-	-	-	-	-	-

Dimensions are based on 18 mm centerline spacing
Note: Bottom & side cylinder ports not available on the same station

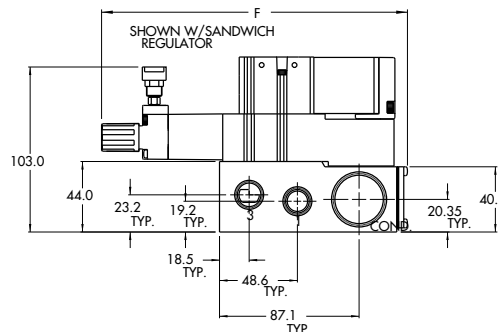
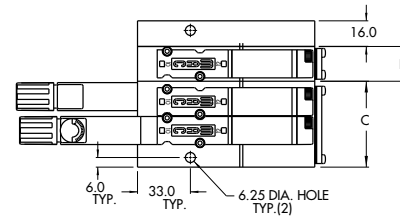
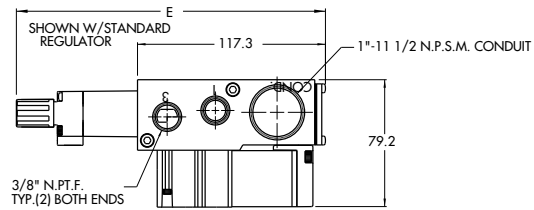
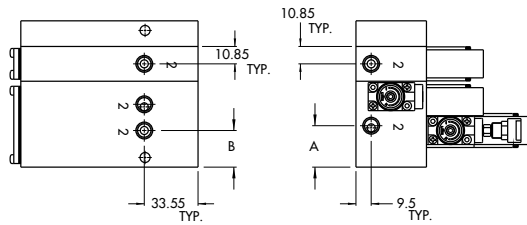

Dim.	1/8"	1/4"	6 mm Legris	1/8" w/regulator	1/4" w/regulator
"A"	22.65	24.20	22.85	-	-
"B"	22.85	22.85	25.85	21.20	22.60

Dim.	Regulator with locking adjusting screw	Regulator with adjusting screw	Regulator with adjusting knob
"E"	188.8	184.7	191.7
"F"	182.5	178.4	185.4



Section 2

Options



Codification table for voltages / Wire length / Manual operators / Electrical connections

VALVE CODE ► **-HXX X - X XX**
1 2 3 4

OPTIONS AVAILABLE FOR

- Solenoid valves 37 & 47 Series

1. VOLTAGE

- H XX	X - X XX	VOLTAGE
DC Options		
<input type="radio"/>	DA	24 VDC (5.2 W)
<input type="radio"/>	DB	24 VDC (2.4 W)
<input type="radio"/>	DC	24 VDC (1.8 W)
<input type="radio"/>	DD	24 VDC (1.0 W)
<input type="radio"/>	DF	12 VDC (5.2 W)
<input type="radio"/>	DG	12 VDC (2.4 W)
<input type="radio"/>	DH	12 VDC (1.8 W)
<input type="radio"/>	DJ	12 VDC (1.0 W)
<input type="radio"/>	DL	120 VDC (6.3 W)
AC Options (50/60hz)		
<input type="radio"/>	AA	120 VAC (6.7 W)
<input type="radio"/>	AB	220 VAC (5.6 W)
<input type="radio"/>	AC	240 VAC (5.8 W)
<input type="radio"/>	AD	24 VAC (7.8 W)

Note : AC Voltages only available with "H" & "F" type connectors. MOD FWR2 must be used with the "F" type connectors.

2. WIRE LENGTH

- H XX	X - X XX	WIRE LENGTH
<input type="radio"/>	O	No lead wire
<input type="radio"/>	A	18"
<input type="radio"/>	B	24"
<input type="radio"/>	C	36"
<input type="radio"/>	D	48"
<input type="radio"/>	E	72"
<input type="radio"/>	F	96"
<input type="radio"/>	G	120"
<input type="radio"/>	H	144"
<input type="radio"/>	P	Plug-in (used only with "F" type connector Opts.)

Use "O" with MJ & MM Opts.

3. MANUAL OPERATOR

- H XX	X - X XX	MANUAL OPERATOR
<input type="radio"/>	0	No operator
<input type="radio"/>	1	Non-locking recessed
<input type="radio"/>	2	Locking recessed
<input type="radio"/>	3	Non-locking extended
<input type="radio"/>	4	Locking extended



4. ELECTRICAL CONNECTION

- H XX	X - X XX	ELECTRICAL CONNECTION
<input type="radio"/>	BA	Flying leads
<input type="radio"/>	BB	Flying leads with ground wire
<input type="radio"/>	BC	Flying leads with led light
<input type="radio"/>	BD	Flying leads with led light & ground wire
<input type="radio"/>	BE	Flying leads with suppression diode
<input type="radio"/>	BF	Flying leads with suppression diode & ground wire
<input type="radio"/>	BG	Flying leads with suppression diode plus led light
<input type="radio"/>	BH	Flying leads with suppression diode plus led light & ground wire
<input type="radio"/>	*BN	Flying leads with suppression diode plus blocking diode
<input type="radio"/>	*BP	Flying leads with suppression diode plus blocking diode & ground wire
<input type="radio"/>	*BR	Flying leads with suppression diode plus blocking diode & led light
<input type="radio"/>	*BS	Flying leads with suppression diode plus blocking diode & led light & ground wire
<input type="radio"/>	FA	Plug-in
<input type="radio"/>	FB	Plug-in with ground wire
<input type="radio"/>	FC	Plug-in with led light
<input type="radio"/>	FD	Plug-in with led light & ground wire
<input type="radio"/>	FE	Plug-in with suppression diode
<input type="radio"/>	FF	Plug-in with suppression diode & ground wire
<input type="radio"/>	FG	Plug-in with suppression diode plus led light
<input type="radio"/>	FH	Plug-in with suppression diode plus led light & ground wire
		Note : FA ---- FH options for use with ECD type circuit bars
<input type="radio"/>	HA	Circuit board plug-in with full wave rectifier & led light
<input type="radio"/>	HB	Circuit board with full wave rectifier & led with ground wire
<input type="radio"/>	HC	Same as "HA" without lead wires
<input type="radio"/>	HD	Same as "HB" without lead wires
<input type="radio"/>	HL	Circuit board plug-in with suppression diode plus blocking diode & led light
<input type="radio"/>	HN	Same as "HL" without lead wires
<input type="radio"/>	MA	Plug-in wire assembly
<input type="radio"/>	MB	Plug-in wire assembly with ground wire
<input type="radio"/>	MC	Plug-in wire assembly with led light
<input type="radio"/>	MD	Plug-in wire assembly led light & ground wire
<input type="radio"/>	ME	Plug-in wire assembly with suppression diode
<input type="radio"/>	MF	Plug-in wire assembly with suppression diode & ground wire
<input type="radio"/>	*MG	Plug-in wire assembly suppression diode plus led light
<input type="radio"/>	*MH	Plug-in wire assembly suppression diode plus led light & ground wire
<input type="radio"/>	*MN	Plug-in wire assembly with suppression diode plus blocking diode
<input type="radio"/>	*MP	Plug-in wire assembly with suppression diode plus blocking diode & ground wire
<input type="radio"/>	MR	Plug-in wire assembly with suppression diode plus blocking diode & led light
<input type="radio"/>	MS	Plug-in wire assembly with suppression diode plus blocking diode & led light & ground wire
<input type="radio"/>	MJ	Plug-in housing w/o wire assembly ("MA" option without wire assembly)
<input type="radio"/>	MM	Plug-in housing w/o wire assembly ("MB" option without wire assembly)

* Blocking diode is in lead wire.

MOD. S009

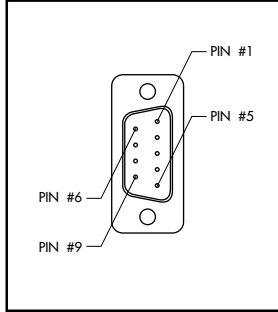

TECHNICAL DATA

- Type «SUB_D»
- Number of contacts : 9
- Solder termination (Dia. 0.6 mm/0.14 mm²/26-22 AWG)
- Operating current 5 A/contact
- Rated voltage 125 V~
- Temp. range -40° to +125°C
- Insulation resistance ≥ 5.0⁹ Ω
- Protection class IP40 (DIN 40050)
- Number of solenoids : 7 max.
- Max. 24 V=/5.4 W per solenoid
- 2 common wires

MOD. S015

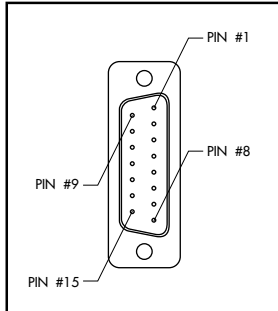

TECHNICAL DATA

- Type «SUB_D»
- Number of contacts : 15
- Solder termination (Dia. 0.6 mm/0.14 mm²/26-22 AWG)
- Operating current 5 A/contact
- Rated voltage 125 V~
- Temp. range -40° to +125°C
- Insulation resistance ≥ 5.0⁹ Ω
- Protection class IP40 (DIN 40050)
- Number of solenoids : 12 max.
- Max. 24 V=/5.4 W per solenoid
- 3 common wires

MOD. S025

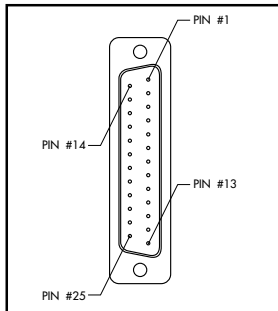

TECHNICAL DATA

- Type «SUB_D»
- Number of contacts : 25
- Solder termination (Dia. 0.6 mm/0.14 mm²/26-22 AWG)
- Operating current 5 A/contact
- Rated voltage 125 V~
- Temp. range -40° to +125°C
- Insulation resistance ≥ 5.0⁹ Ω
- Protection class IP40 (DIN 40050)
- Number of solenoids : 20 max.
- Max. 24 V=/5.4 W per solenoid
- 5 common wires

Note : Use desired MOD. number after circuit bar part number

Connector termination details

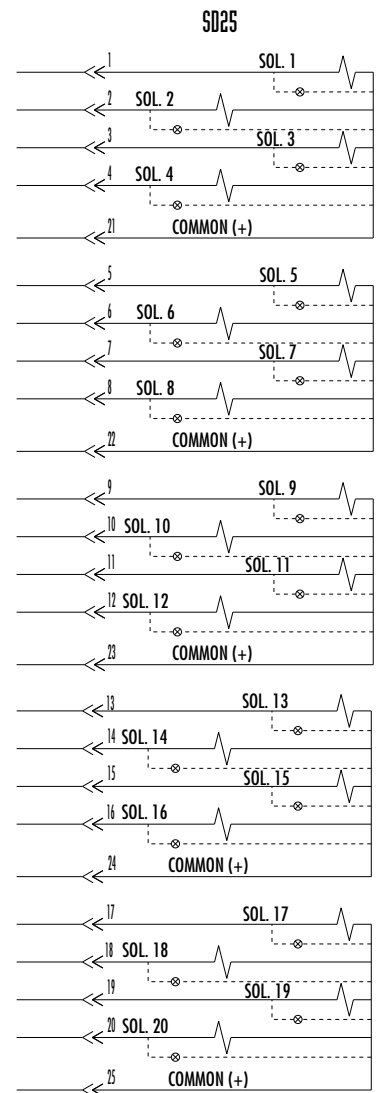
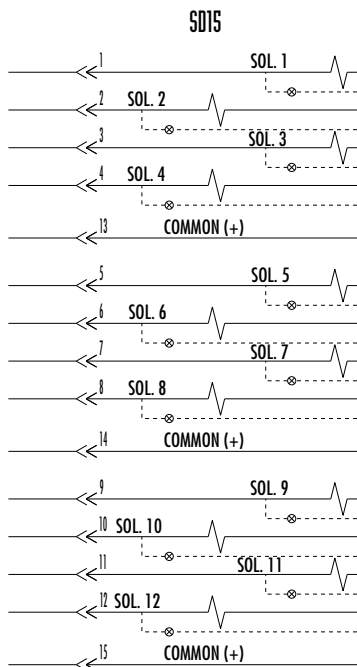
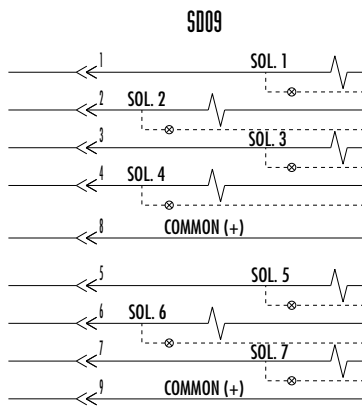
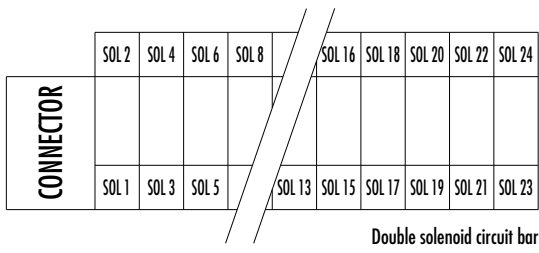
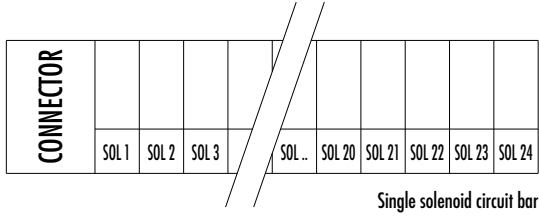

Circuit bar mounting

cylinder ports in valve	add-on style cylinder ports in valve	cylinder ports in base	add-on style cylinder ports in base	add-a-unit stations for CBM052A bar	add-a-unit stations for CBP052A bar
-------------------------	--------------------------------------	------------------------	-------------------------------------	-------------------------------------	-------------------------------------

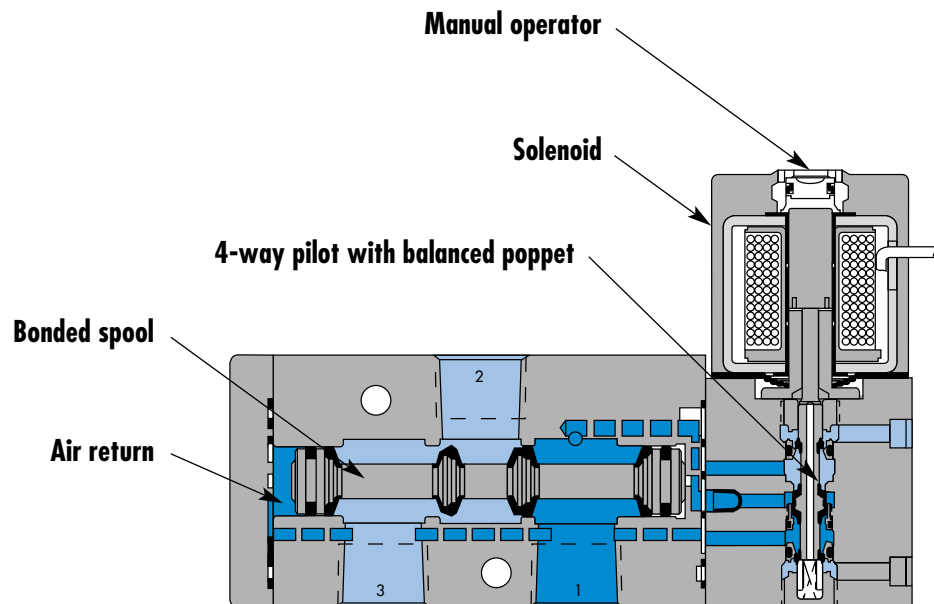

SERIES FEATURES

- Patented MACSOLENOID[®] for fastest possible response times and virtually burn-out proof AC solenoid operation.
- Optional low watt DC solenoids.
- Various manual operators.
- Optional memory spring.
- Normally closed or normally open valve function.
- May be plugged for 2-way operation.
- Internal or external pilot.

Function	Port size	Flow [Max]	Circuit bar mounting
3/2 NO-NC	1/8" - 1/4"	1.2C_v	cylinder ports in valve

OPERATIONAL BENEFITS

1. The 4-way pilot develops maximum shifting forces both ways.
2. Memory spring available.
3. Balanced spool, immune to variations of pressure, also provides high flow.
4. Short stroke with high flow.
5. Bonded spool with minimum friction, shifting in a glass-like finished bore.
6. Pilot with balanced poppet, high flow, short and consistent response times.
7. Wiping effect eliminates sticking.
8. Long service life.



HOW TO ORDER

52A-xx-xxx-DM-Dxxx-xxx

SOLENOID OPERATOR

Port size	Pilot air	Single operator		Double operator	
		NO valve	NC valve	NO valve	NC valve
1/8" NPTF	Internal	<input type="radio"/> 52A-31-AOA-DM-Dxxx-xxx	<input type="radio"/> 52A-11-AOA-DM-Dxxx-xxx	<input type="radio"/> 52A-41-AOA-DM-Dxxx-xxx	<input type="radio"/> 52A-21-AOA-DM-Dxxx-xxx
1/4" NPTF		<input type="radio"/> 52A-31-BOA-DM-Dxxx-xxx	<input type="radio"/> 52A-11-BOA-DM-Dxxx-xxx	<input type="radio"/> 52A-41-BOA-DM-Dxxx-xxx	<input type="radio"/> 52A-21-BOA-DM-Dxxx-xxx
1/8" NPTF	External	<input type="radio"/> 52A-31-AOC-DM-Dxxx-xxx	<input type="radio"/> 52A-11-AOC-DM-Dxxx-xxx	<input type="radio"/> 52A-41-AOC-DM-Dxxx-xxx	<input type="radio"/> 52A-21-AOC-DM-Dxxx-xxx
1/4" NPTF		<input type="radio"/> 52A-31-BOC-DM-Dxxx-xxx	<input type="radio"/> 52A-11-BOC-DM-Dxxx-xxx	<input type="radio"/> 52A-41-BOC-DM-Dxxx-xxx	<input type="radio"/> 52A-21-BOC-DM-Dxxx-xxx

SOLENOID OPERATOR >

D **XX X - X XX***

XX	Voltage	X	Wire length	X	Manual operator	XX	Electrical connection
<input type="radio"/> JA	120/60, 110/50	<input type="radio"/> A	18" (Flying leads)	<input type="radio"/> 1	Non-locking	<input type="radio"/> KA	Square connector
<input type="radio"/> JB	240/60, 220/50	<input type="radio"/> J	Connector	<input type="radio"/> 2	Locking	<input type="radio"/> KD	Square connector with light
<input type="radio"/> JC	24/60, 24/50	<input type="radio"/> x	Other Options	<input type="radio"/> x	Other Options	<input type="radio"/> JB	Rectangular connector
<input type="radio"/> DA	24VDC (5.4 W)					<input type="radio"/> JD	Rectangular connector with light
<input type="radio"/> FB	24VDC (1.8 W)					<input type="radio"/> BA	Flying leads
<input type="radio"/> DF	24VDC (12.7 W)					<input type="radio"/> xx	Other Options
<input type="radio"/> xx	Other Options						

CBM052A-xxxxx-xx

HOW TO ORDER CIRCUIT BAR **

Port size	Pilot air	Spacing standard 19,5 mm	Spacing 26 mm (Rectangular connector)
3/8" NPTF	Internal	<input type="radio"/> CBM052A-00AAA-xx	<input type="radio"/> CBM052A-02AAA-xx
	External	<input type="radio"/> CBM052A-00CAA-xx	<input type="radio"/> CBM052A-02CAA-xx

Number of stations (03=3 stations)
 ** Other options available. Consult factory.

OPTIONS

52A-31-AOA-DM-Dxxx-xxx

clic for memory spring (replace by 4).

**T E C H N I C A L
D A T A**

Fluid :	Compressed air, vacuum, inert gases
Pressure range :	Internal pilot : 20 - 150 PSI External pilot : vacuum to 150 PSI
Pilot pressure :	20 - 150 PSI
Lubrication :	Not required, if used select a medium aniline point lubricant (between 180°F to 210°F)
Filtration :	40 µ
Temperature range :	0°F to 120°F (-18°C to +50°C)
Orifice :	7.3 mm
Flow :	1.2C _v
Coil :	General purpose class A, continuous duty, encapsulated
Voltage range :	-15% to +10% of nominal voltage
Protection :	NEMA 4
Power :	~ Inrush : 10.9 VA Holding : 7.7 VA = 1.8 to 12.7 W
Response times :	24 V= / 5.4 W Energize : 7.3 ms De-energize : 5.3ms 60Hz/6 W Energize : 8-12 ms De-energize : 7-11 ms

- Spare parts : • Pilot valve : DMB-DXXX-XXX-1, including mounting screws 35043 and seal 16524.
- Accessories • Blanking plate : M-04001. • Seal (x3) : 17015-01. • Mounting screw (x2) : 35043.
- Options : • BSPP threads. • Isolation of inlet and/or exhaust.

D I M E N S I O N S

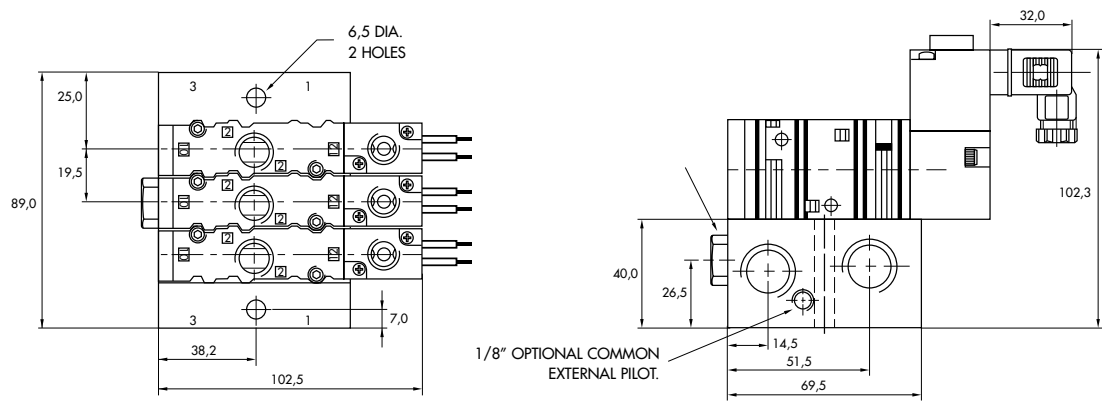

Function	Port size	Flow [Max]	Circuit bar mounting
3/2 NO-NC	1/8" - 1/4"	1.2C_v	add-on style cylinder ports in valve

OPERATIONAL BENEFITS

1. The 4-way pilot develops maximum shifting forces both ways.
2. Memory spring available.
3. Balanced spool, immune to variations of pressure, also provides high flow.
4. Short stroke with high flow.
5. Bonded spool with minimum friction, shifting in a glass-like finished bore.
6. Pilot with balanced poppet, high flow, short and consistent response times.
7. Wiping effect eliminates sticking.
8. Long service life.

Reset



HOW TO ORDER

52A-xx-xxx-DM-Dxxx-xxx

SOLENOID OPERATOR

Port size	Pilot air	Single operator		Double operator	
		NO valve	NC valve	NO valve	NC valve
1/8" NPTF	Internal	<input type="radio"/> 52A-31-AOA-DM-Dxxx-xxx	<input type="radio"/> 52A-11-AOA-DM-Dxxx-xxx	<input type="radio"/> 52A-41-AOA-DM-Dxxx-xxx	<input type="radio"/> 52A-21-AOA-DM-Dxxx-xxx
1/4" NPTF		<input type="radio"/> 52A-31-BOA-DM-Dxxx-xxx	<input type="radio"/> 52A-11-BOA-DM-Dxxx-xxx	<input type="radio"/> 52A-41-BOA-DM-Dxxx-xxx	<input type="radio"/> 52A-21-BOA-DM-Dxxx-xxx
1/8" NPTF	External	<input type="radio"/> 52A-31-AOC-DM-Dxxx-xxx	<input type="radio"/> 52A-11-AOC-DM-Dxxx-xxx	<input type="radio"/> 52A-41-AOC-DM-Dxxx-xxx	<input type="radio"/> 52A-21-AOC-DM-Dxxx-xxx
1/4" NPTF		<input type="radio"/> 52A-31-BOC-DM-Dxxx-xxx	<input type="radio"/> 52A-11-BOC-DM-Dxxx-xxx	<input type="radio"/> 52A-41-BOC-DM-Dxxx-xxx	<input type="radio"/> 52A-21-BOC-DM-Dxxx-xxx

SOLENOID OPERATOR >

D XX X - X XX*

XX Voltage	X Wire length	X Manual operator	XX Electrical connection
<input type="radio"/> JA 120/60, 110/50	<input type="radio"/> A 18" (Flying leads)	<input type="radio"/> 1 Non-locking	<input type="radio"/> KA Square connector
<input type="radio"/> JB 240/60, 220/50	<input type="radio"/> J Connector	<input type="radio"/> 2 Locking	<input type="radio"/> KD Square connector with light
<input type="radio"/> JC 24/60, 24/50	<input type="radio"/> x Other Options	<input type="radio"/> x Other Options	<input type="radio"/> JB Rectangular connector
<input type="radio"/> DA 24VDC (5.4 W)			<input type="radio"/> JD Rectangular connector with light
<input type="radio"/> FB 24VDC (1.8 W)			<input type="radio"/> BA Flying leads
<input type="radio"/> DF 24VDC (12.7 W)			<input type="radio"/> xx Other Options
<input type="radio"/> xx Other Options			

CBM052A-xxxxx-xx

HOW TO ORDER CIRCUIT BAR **

Port size	Pilot air	Spacing standard 19,5 mm	Spacing 26 mm (Rectangular connector)
3/8" NPTF	Internal	<input type="radio"/> CBM052A-00ABA-xx	<input type="radio"/> CBM052A-02ABA-xx
	External	<input type="radio"/> CBM052A-00CBA-xx	<input type="radio"/> CBM052A-02CBA-xx

Number of stations (03=3 stations)
 ** Other options available. Consult factory.

Note : add-a-unit stations may be added to above bars. Click here for model numbers.

OPTIONS

52A-31-AOA-DM-Dxxx-xxx

clic for memory spring (replace by 4).

**TECHNICAL
DATA**

Fluid :	Compressed air, vacuum, inert gases		
Pressure range :	Internal pilot : 20 - 150 PSI External pilot : vacuum to 150 PSI		
Pilot pressure :	20 - 150 PSI		
Lubrication :	Not required, if used select a medium aniline point lubricant (between 180°F to 210°F)		
Filtration :	40 µ		
Temperature range :	0°F to 120°F (-18°C to +50°C)		
Orifice :	7.3 mm		
Flow :	1.2C _v		
Coil :	General purpose class A, continuous duty, encapsulated		
Voltage range :	-15% to +10% of nominal voltage		
Protection :	NEMA 4		
Power :	- Inrush : 10.9 VA Holding : 7.7 VA = 1.8 to 12.7 W		
Response times :	24 V= /5.4 W	Energize : 7.3 ms	De-energize : 5.3ms
	60Hz/6 W	Energize : 8-12 ms	De-energize : 7-11 ms

- Spare parts : • Pilot valve : DMB-DXXX-XXX-1, including mounting screws 35043 and seal 16524.
- Accessories • Blanking plate : M-04001. • Seal (x3) : 17015-01. • Mounting screw (x2) : 35043. • End plate kit (Internal) : M-52001-01.
• End plate kit (External) : M-52002-01.
- Options : • BSPP threads. • Isolation of inlet and/or exhaust.

DIMENSIONS

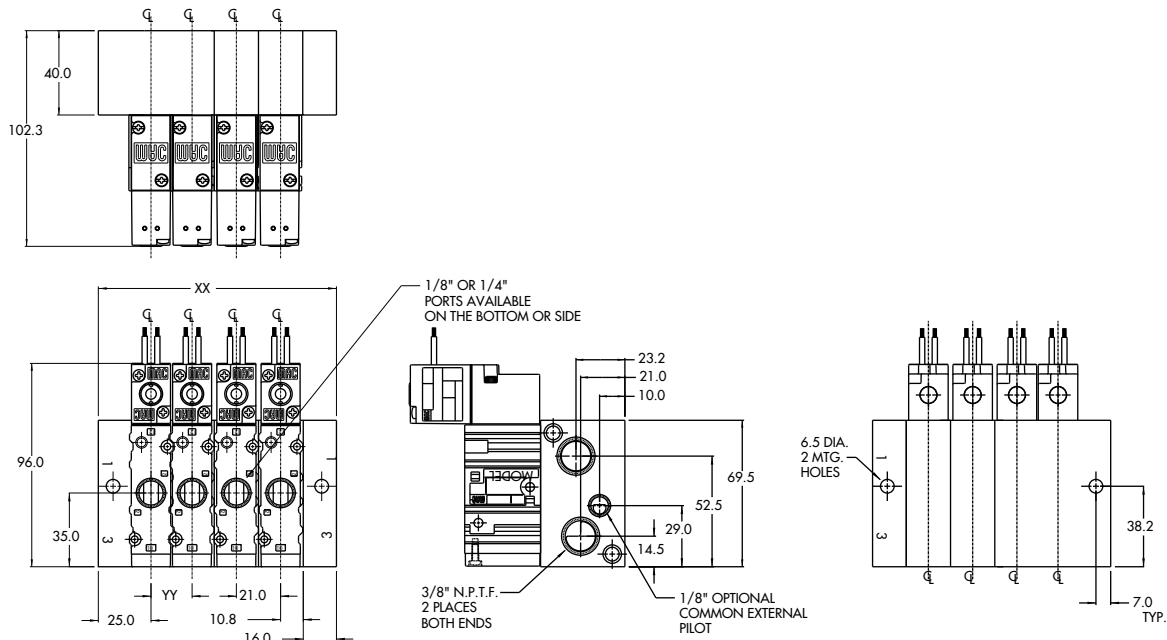

YY	XX
19.5	113
26	119.5

Function	Port size	Flow [Max]	Individual mounting
3/2 NO-NC	1/8" - 1/4"	1.2C_v	cylinder ports in base

OPERATIONAL BENEFITS

1. The 4-way pilot develops maximum shifting forces both ways.
2. Memory spring available.
3. Balanced spool, immune to variations of pressure, also provides high flow.
4. Short stroke with high flow.
5. Bonded spool with minimum friction, shifting in a glass-like finished bore.
6. Pilot with balanced poppet, high flow, short and consistent response times.
7. Wiping effect eliminates sticking.
8. Long service life.

Reset

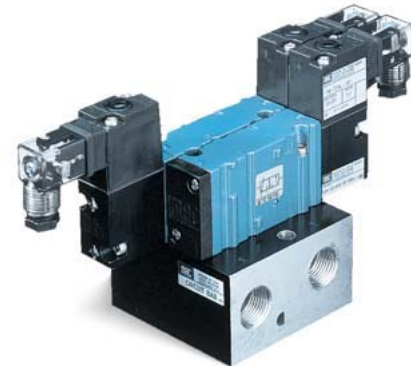

HOW TO ORDER

52A-xx-xxx-DM-Dxxx-xxx

HOW TO ORDER VALVE FOR CIRCUIT BAR MOUNTING

Pilot air	Single operator		Double operator	
	NO valve	NC valve	NO valve	NC valve
Internal				
External				
	<input type="radio"/> 52A-33-OOA-DM-Dxxx-xxx	<input type="radio"/> 52A-13-OOA-DM-Dxxx-xxx	<input type="radio"/> 52A-43-OOA-DM-Dxxx-xxx	<input type="radio"/> 52A-23-OOA-DM-Dxxx-xxx
	<input type="radio"/> 52A-33-OOC-DM-Dxxx-xxx	<input type="radio"/> 52A-13-OOC-DM-Dxxx-xxx	<input type="radio"/> 52A-43-OOC-DM-Dxxx-xxx	<input type="radio"/> 52A-23-OOC-DM-Dxxx-xxx

SOLENOID OPERATOR >

D **XX X - X XX***

XX	Voltage	X	Wire length	X	Manual operator	XX	Electrical connection
<input type="radio"/> JA	120/60, 110/50	<input type="radio"/> A	18" (Flying leads)	<input type="radio"/> 1	Non-locking	<input type="radio"/> KA	Square connector
<input type="radio"/> JB	240/60, 220/50	<input type="radio"/> J	Connector	<input type="radio"/> 2	Locking	<input type="radio"/> KD	Square connector with light
<input type="radio"/> JC	24/60, 24/50	<input type="radio"/> x	Other Options	<input type="radio"/> x	Other Options	<input type="radio"/> JB	Rectangular connector
<input type="radio"/> DA	24VDC (5.4 W)					<input type="radio"/> JD	Rectangular connector with light
<input type="radio"/> FB	24VDC (1.8 W)					<input type="radio"/> BA	Flying leads
<input type="radio"/> DF	24VDC (12.7 W)					<input type="radio"/> xx	Other Options
<input type="radio"/> xx	Other Options						

CBP052A-xxxxx-xx

HOW TO ORDER CIRCUIT BAR **

Port size (NPTF)	Pilot air	Spacing standard 19,5 mm	Spacing 26 mm (Rectangular connector)
1/8" SIDE PORT	Internal	<input type="radio"/> CBP052A-00AAA-xx	<input type="radio"/> CBP052A-02AAA-xx
1/4" SIDE PORT		<input type="radio"/> CBP052A-00AAD-xx	<input type="radio"/> CBP052A-02AAD-xx
1/8" SIDE PORT	External	<input type="radio"/> CBP052A-00EAA-xx	<input type="radio"/> CBP052A-02EAA-xx
1/4" SIDE PORT		<input type="radio"/> CBP052A-00EAD-xx	<input type="radio"/> CBP052A-02EAD-xx
1/8" BOTTOM PORT	Internal	<input type="radio"/> CBP052A-00BAA-xx	<input type="radio"/> CBP052A-02BAA-xx
1/4" BOTTOM PORT		<input type="radio"/> CBP052A-00BAD-xx	<input type="radio"/> CBP052A-02BAD-xx
1/8" BOTTOM PORT	External	<input type="radio"/> CBP052A-00FAA-xx	<input type="radio"/> CBP052A-02FAA-xx
1/4" BOTTOM PORT		<input type="radio"/> CBP052A-00FAD-xx	<input type="radio"/> CBP052A-02FAD-xx

Number of stations (03=3 stations) **

Other options available. Consult factory.

OPTIONS

52A-33-OOA-DM-Dxxx-xxx

clic for memory spring (replace by 6).

**TECHNICAL
DATA**

Fluid :	Compressed air, vacuum, inert gases
Pressure range :	Internal pilot : 20 - 150 PSI External pilot : vacuum to 150 PSI
Pilot pressure :	20 - 150 PSI
Lubrication :	Not required, if used select a medium aniline point lubricant (between 180°F to 210°F)
Filtration :	40 µ
Temperature range :	0°F to 120°F (-18°C to +50°C)
Orifice :	7.3 mm
Coil :	General purpose class A, continuous duty, encapsulated
Voltage range :	-15% to +10% of nominal voltage
Protection :	NEMA 4
Power :	~ Inrush : 10.9 VA Holding : 7.7 VA = 1.8 to 12.7 W
Response times :	24 V=/5.4 W Energize : 7.3 ms De-energize : 5.3ms 60Hz/6 W Energize : 8-12 ms De-energize : 7-11 ms

- Spare parts : • Pilot valve : DMB-DXXX-XXX-1, including mounting screws 35043 and seal 16524.
- Accessories • Blanking plate : M-52003. • Seal (x3) : 17013-01. • Mounting screw (x2) : 35043.
- Options : • BSPP threads. • Isolation of inlet and/or exhaust.

DIMENSIONS

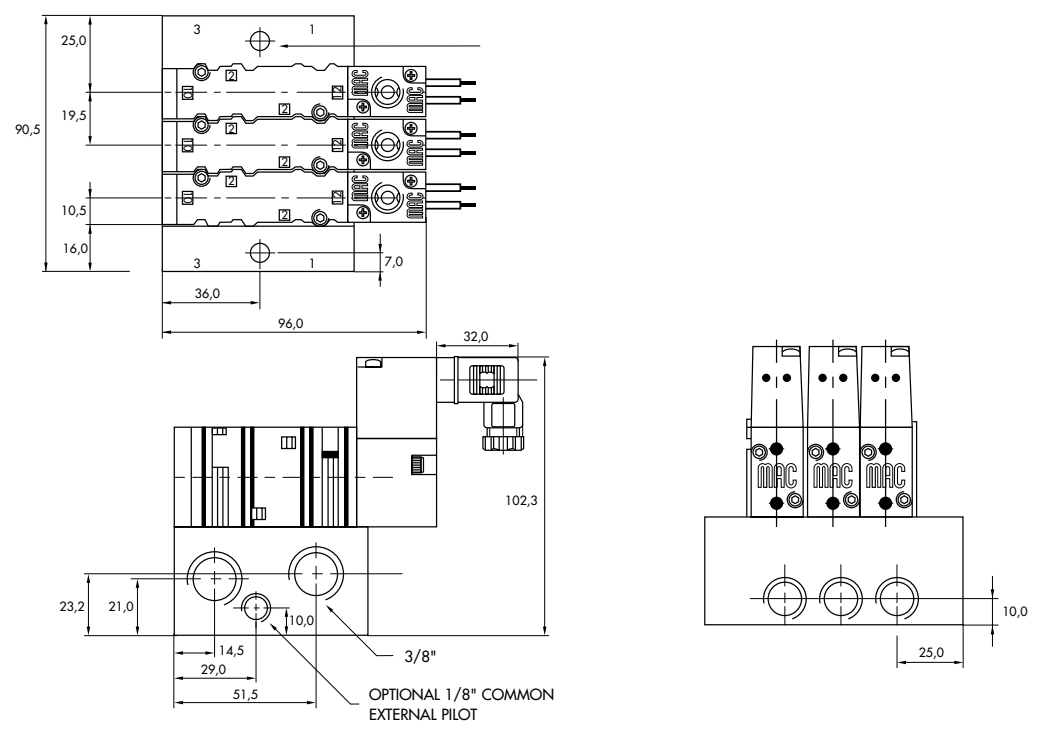

Function	Port size	Flow [Max]	Individual mounting
3/2 NO-NC	1/8" - 1/4"	1.2C_v	add-on style cylinder ports in base

OPERATIONAL BENEFITS

1. The 4-way pilot develops maximum shifting forces both ways.
2. Memory spring available.
3. Balanced spool, immune to variations of pressure, also provides high flow.
4. Short stroke with high flow.
5. Bonded spool with minimum friction, shifting in a glass-like finished bore.
6. Pilot with balanced poppet, high flow, short and consistent response times.
7. Wiping effect eliminates sticking.
8. Long service life.

Reset

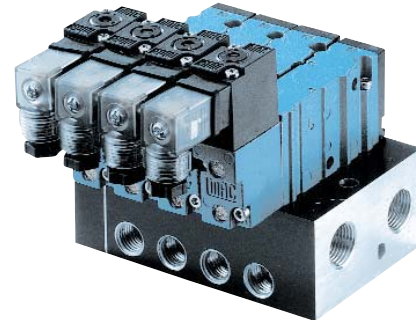

HOW TO ORDER

52A-xx-xxx-DM-Dxxx-xxx

HOW TO ORDER VALVE FOR CIRCUIT BAR MOUNTING

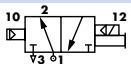
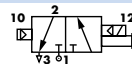
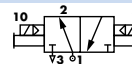
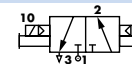
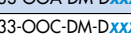
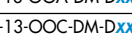
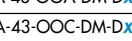
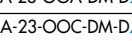
Pilot air	Single operator		Double operator	
	NO valve	NC valve	NO valve	NC valve
Internal	 52A-33-OOA-DM-Dxxx-xxx	 52A-13-OOA-DM-Dxxx-xxx	 52A-43-OOA-DM-Dxxx-xxx	 52A-23-OOA-DM-Dxxx-xxx
External	 52A-33-OOC-DM-Dxxx-xxx	 52A-13-OOC-DM-Dxxx-xxx	 52A-43-OOC-DM-Dxxx-xxx	 52A-23-OOC-DM-Dxxx-xxx

SOLENOID OPERATOR >

D **XX X - X XX**

XX Voltage	X Wire length	X Manual operator	XX Electrical connection
<input type="radio"/> JA 120/60, 110/50	<input type="radio"/> A 18" (Flying leads)	<input type="radio"/> 1 Non-locking	<input type="radio"/> KA Square connector
<input type="radio"/> JB 240/60, 220/50	<input type="radio"/> J Connector	<input type="radio"/> 2 Locking	<input type="radio"/> KD Square connector with light
<input type="radio"/> JC 24/60, 24/50	<input type="radio"/> x Other Options	<input type="radio"/> x Other Options	<input type="radio"/> JB Rectangular connector
<input type="radio"/> DA 24VDC (5.4 W)			<input type="radio"/> JD Rectangular connector with light
<input type="radio"/> FB 24VDC (1.8 W)			<input type="radio"/> BA Flying leads
<input type="radio"/> DF 24VDC (12.7 W)			<input type="radio"/> xx Other Options
<input type="radio"/> xx Other Options			

CBP052A-xxxxx-xx

HOW TO ORDER CIRCUIT BAR **

Port size (NPTF)	Pilot air	Spacing standard 19,5 mm	Spacing 26 mm (Rectangular connector)
1/8" SIDE PORT	Internal	<input type="radio"/> CBP052A-00ABA-xx	<input type="radio"/> CBP052A-02ABA-xx
1/4" SIDE PORT	Internal	<input type="radio"/> CBP052A-00ABD-xx	<input type="radio"/> CBP052A-02ABD-xx
1/8" SIDE PORT	External	<input type="radio"/> CBP052A-00EBA-xx	<input type="radio"/> CBP052A-02EBA-xx
1/4" SIDE PORT	External	<input type="radio"/> CBP052A-00EBD-xx	<input type="radio"/> CBP052A-02EBD-xx
1/8" BOTTOM PORT	Internal	<input type="radio"/> CBP052A-00BBA-xx	<input type="radio"/> CBP052A-02BBA-xx
1/4" BOTTOM PORT	Internal	<input type="radio"/> CBP052A-00BBD-xx	<input type="radio"/> CBP052A-02BBD-xx
1/8" BOTTOM PORT	External	<input type="radio"/> CBP052A-00FBA-xx	<input type="radio"/> CBP052A-02FBA-xx
1/4" BOTTOM PORT	External	<input type="radio"/> CBP052A-00FBD-xx	<input type="radio"/> CBP052A-02FBD-xx

Number of stations (03=3 stations) **

Other options available. Consult factory.

Note : add-a-unit stations may be added to above bars. Click here for model numbers.

OPTIONS

52A-33-OOA-DM-Dxxx-xxx

clic for memory spring (replace by 6).

Consult "Precautions" before use, installation or service of MAC Valves.

**TECHNICAL
DATA**

Fluid :	Compressed air, vacuum, inert gases		
Pressure range :	Internal pilot : 20 - 150 PSI External pilot : vacuum to 150 PSI		
Pilot pressure :	20 - 150 PSI		
Lubrication :	Not required, if used select a medium aniline point lubricant (between 180°F to 210°F)		
Filtration :	40 µ		
Temperature range :	0°F to 120°F (-18°C to +50°C)		
Orifice :	7.3 mm		
Flow :	1.2C _v		
Coil :	General purpose class A, continuous duty, encapsulated		
Voltage range :	-15% to +10% of nominal voltage		
Protection :	NEMA 4		
Power :	- Inrush : 10.9 VA Holding : 7.7 VA = 1.8 to 12.7 W		
Response times :	24 V=/5.4 W	Energize : 7.3 ms	De-energize : 5.3ms
	60Hz/6 W	Energize : 8-12 ms	De-energize : 7-11 ms

- Spare parts : • Pilot valve : DMB-DXXX-XXX-1, including mounting screws 35043 and seal 16524.
- Accessories • Blanking plate : M-52003. • Seal (x3) : 17013-01. • Mounting screw (x2) : 35043. • End plate kit (Internal) : M-52001-01.
• End plate kit (External) : M-52002-01.
- Options : • BSPP threads. • Isolation of inlet and/or exhaust.

DIMENSIONS

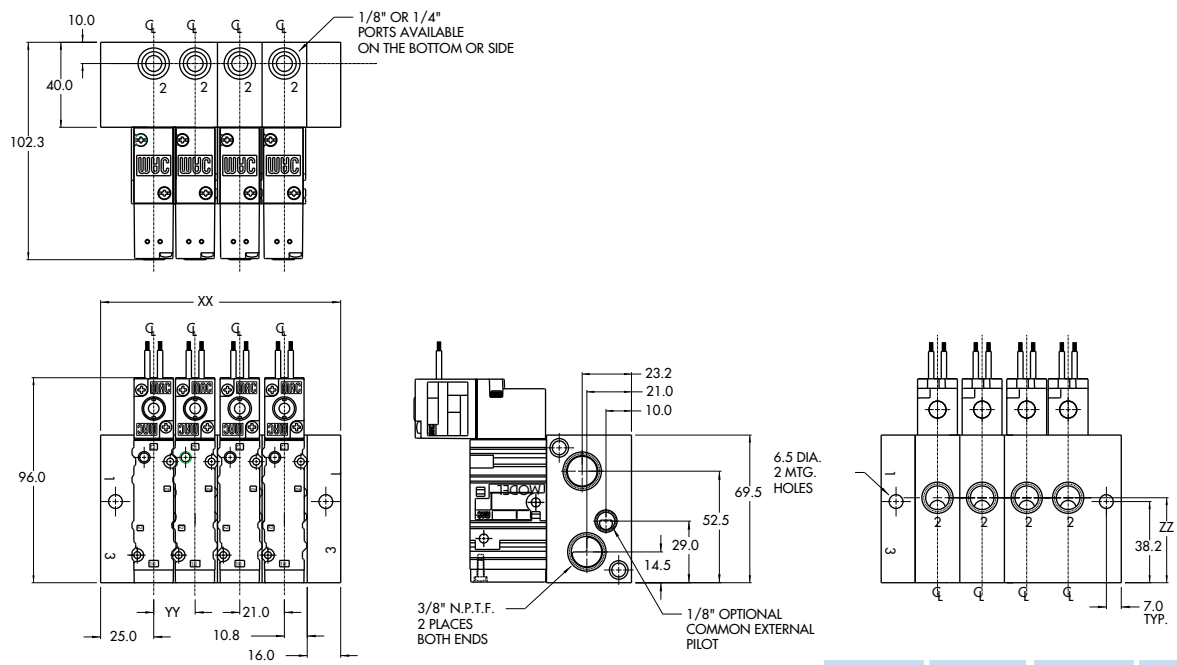

YY	XX	PORT	ZZ
19.5	113	1/8"	36.0
26	119.5	1/4"	40.0

Note: Bottom & side cylinder ports not available on the same station

Function	Port size	Flow [Max]	Circuit bar mounting
3/2 NO-NC	1/8" - 1/4"	1.2C_v	add-a-unit stations for CBM052A bar

OPERATIONAL BENEFITS

1. The 4-way pilot develops maximum shifting forces both ways.
2. Memory spring available.
3. Balanced spool, immune to variations of pressure, also provides high flow.
4. Short stroke with high flow.
5. Bonded spool with minimum friction, shifting in a glass-like finished bore.
6. Pilot with balanced poppet, high flow, short and consistent response times.
7. Wiping effect eliminates sticking.
8. Long service life.



HOW TO ORDER

52A-xx-xxx-DM-Dxxx-xxx

SOLENOID OPERATOR

Port size	Pilot air	Single operator		Double operator	
		NO valve	NC valve	NO valve	NC valve
1/8" NPTF	Internal	<input type="radio"/> 52A-31-AOA-DM-Dxxx-xxx	<input type="radio"/> 52A-11-AOA-DM-Dxxx-xxx	<input type="radio"/> 52A-41-AOA-DM-Dxxx-xxx	<input type="radio"/> 52A-21-AOA-DM-Dxxx-xxx
1/4" NPTF		<input type="radio"/> 52A-31-BOA-DM-Dxxx-xxx	<input type="radio"/> 52A-11-BOA-DM-Dxxx-xxx	<input type="radio"/> 52A-41-BOA-DM-Dxxx-xxx	<input type="radio"/> 52A-21-BOA-DM-Dxxx-xxx
1/8" NPTF	External	<input type="radio"/> 52A-31-AOC-DM-Dxxx-xxx	<input type="radio"/> 52A-11-AOC-DM-Dxxx-xxx	<input type="radio"/> 52A-41-AOC-DM-Dxxx-xxx	<input type="radio"/> 52A-21-AOC-DM-Dxxx-xxx
1/4" NPTF		<input type="radio"/> 52A-31-BOC-DM-Dxxx-xxx	<input type="radio"/> 52A-11-BOC-DM-Dxxx-xxx	<input type="radio"/> 52A-41-BOC-DM-Dxxx-xxx	<input type="radio"/> 52A-21-BOC-DM-Dxxx-xxx

SOLENOID OPERATOR >

D **XX X - X XX***

XX Voltage	X Wire length	X Manual operator	XX Electrical connection
<input type="radio"/> JA 120/60, 110/50	<input type="radio"/> A 18" (Flying leads)	<input type="radio"/> 1 Non-locking	<input type="radio"/> KA Square connector
<input type="radio"/> JB 240/60, 220/50	<input type="radio"/> J Connector	<input type="radio"/> 2 Locking	<input type="radio"/> KD Square connector with light
<input type="radio"/> JC 24/60, 24/50	<input type="radio"/> x Other Options	<input type="radio"/> x Other Options	<input type="radio"/> JB Rectangular connector
<input type="radio"/> DA 24VDC (5.4 W)			<input type="radio"/> JD Rectangular connector with light
<input type="radio"/> FB 24VDC (1.8 W)			<input type="radio"/> BA Flying leads
<input type="radio"/> DF 24VDC (12.7 W)			<input type="radio"/> xx Other Options
<input type="radio"/> xx Other Options			

HOW TO ORDER CIRCUIT BAR **

CBM052A-xxxxx-xx

Port size	Pilot air	Spacing standard 21 mm	Spacing 26 mm (Rectangular connector)
3/8" NPTF	Internal	<input type="radio"/> CBM052A-01AEA-xx	<input type="radio"/> CBM052A-02AEA-xx
	External	<input type="radio"/> CBM052A-01CEA-xx	<input type="radio"/> CBM052A-02CEA-xx

Number of stations (01=1 station)
 ** Other options available. Consult factory.

Note : add-a-unit stations available in lengths up to 4 stations (01, 02, 03 or 04).

OPTIONS

52A-31-AOA-DM-Dxxx-xxx

clic for memory spring (replace by 4).

**TECHNICAL
DATA**

Fluid :	Compressed air, vacuum, inert gases		
Pressure range :	Internal pilot : 20 - 150 PSI External pilot : vacuum to 150 PSI		
Pilot pressure :	20 - 150 PSI		
Lubrication :	Not required, if used select a medium aniline point lubricant (between 180°F to 210°F)		
Filtration :	40 µ		
Temperature range :	0°F to 120°F (-18°C to +50°C)		
Orifice :	7.3 mm		
Flow :	1.2C _v		
Coil :	General purpose class A, continuous duty, encapsulated		
Voltage range :	-15% to +10% of nominal voltage		
Protection :	NEMA 4		
Power :	- Inrush : 10.9 VA Holding : 7.7 VA = 1.8 to 12.7 W		
Response times :	24 V=/5.4 W	Energize : 7.3 ms	De-energize : 5.3ms
	60Hz/6 W	Energize : 8-12 ms	De-energize : 7-11 ms

- Spare parts : • Pilot valve : DMB-DXXX-XXX-1, including mounting screws 35043 and seal 16524.
- Accessories • Blanking plate : M-04001. • Seal (x3) : 17015-01. • Mounting screw (x2) : 35043.
- Options : • BSPP threads. • Isolation of inlet and/or exhaust.

DIMENSIONS

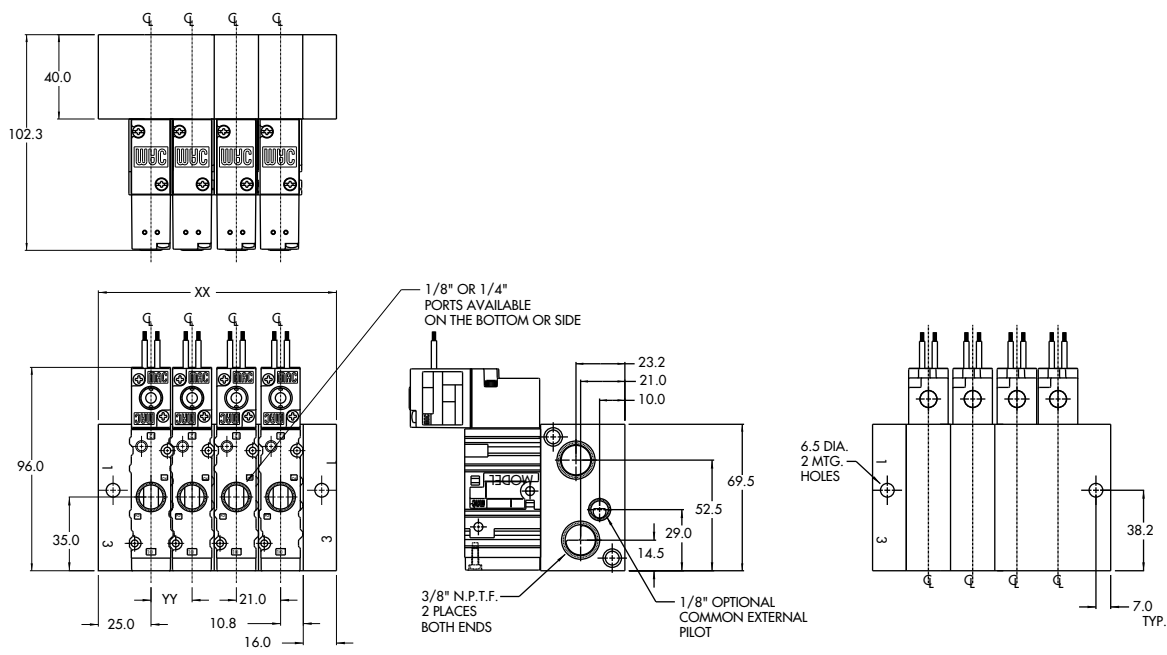

YY	XX
19.5	113
26	119.5

Function	Port size	Flow [Max]	Individual mounting
3/2 NO-NC	1/8" - 1/4"	1.2C_v	add-a-unit stations for CBP052A bar

OPERATIONAL BENEFITS

1. The 4-way pilot develops maximum shifting forces both ways.
2. Memory spring available.
3. Balanced spool, immune to variations of pressure, also provides high flow.
4. Short stroke with high flow.
5. Bonded spool with minimum friction, shifting in a glass-like finished bore.
6. Pilot with balanced poppet, high flow, short and consistent response times.
7. Wiping effect eliminates sticking.
8. Long service life.



HOW TO ORDER

52A-xx-xxx-DM-Dxxx-xxx

HOW TO ORDER VALVE FOR CIRCUIT BAR MOUNTING

Pilot air	Single operator		Double operator	
	NO valve	NC valve	NO valve	NC valve
Internal	52A-33-OOA-DM-Dxxx-xxx	52A-13-OOA-DM-Dxxx-xxx	52A-43-OOA-DM-Dxxx-xxx	52A-23-OOA-DM-Dxxx-xxx
External	52A-33-OOC-DM-Dxxx-xxx	52A-13-OOC-DM-Dxxx-xxx	52A-43-OOC-DM-Dxxx-xxx	52A-23-OOC-DM-Dxxx-xxx

SOLENOID OPERATOR >

D **XXX - XXX**

XX Voltage	X Wire length	X Manual operator	XX Electrical connection
<input type="radio"/> JA 120/60, 110/50	<input type="radio"/> A 18" (Flying leads)	<input type="radio"/> 1 Non-locking	<input type="radio"/> KA Square connector
<input type="radio"/> JB 240/60, 220/50	<input type="radio"/> J Connector	<input type="radio"/> 2 Locking	<input type="radio"/> KD Square connector with light
<input type="radio"/> JC 24/60, 24/50	<input type="radio"/> x Other Options	<input type="radio"/> x Other Options	<input type="radio"/> JB Rectangular connector
<input type="radio"/> DA 24VDC (5.4 W)			<input type="radio"/> JD Rectangular connector with light
<input type="radio"/> FB 24VDC (1.8 W)			<input type="radio"/> BA Flying leads
<input type="radio"/> DF 24VDC (12.7 W)			<input type="radio"/> xx Other Options
<input type="radio"/> xx Other Options			

CBP052A-xxxxx-xx

HOW TO ORDER CIRCUIT BAR **

Port size (NPTF)	Pilot air	Spacing standard 21 mm	Spacing 26 mm (Rectangular connector)
1/8" SIDE PORT	Internal	<input type="radio"/> CBP052A-01AEA-xx	<input type="radio"/> CBP052A-02AEA-xx
1/4" SIDE PORT		<input type="radio"/> CBP052A-01AED-xx	<input type="radio"/> CBP052A-02AED-xx
1/8" SIDE PORT	External	<input type="radio"/> CBP052A-01EEA-xx	<input type="radio"/> CBP052A-02EEA-xx
1/4" SIDE PORT		<input type="radio"/> CBP052A-01EED-xx	<input type="radio"/> CBP052A-02EED-xx
1/8" BOTTOM PORT	Internal	<input type="radio"/> CBP052A-01BEA-xx	<input type="radio"/> CBP052A-02BEA-xx
1/4" BOTTOM PORT		<input type="radio"/> CBP052A-01BED-xx	<input type="radio"/> CBP052A-02BED-xx
1/8" BOTTOM PORT	External	<input type="radio"/> CBP052A-01FEA-xx	<input type="radio"/> CBP052A-02FEA-xx
1/4" BOTTOM PORT		<input type="radio"/> CBP052A-01FED-xx	<input type="radio"/> CBP052A-02FED-xx

Number of stations (03=3 stations) **

Other options available. Consult factory.

Note : add-a-unit stations available in lengths up to 4 stations (01, 02, 03 or 04).

OPTIONS

52A-33-OOA-DM-Dxxx-xxx

clic for memory spring (replace by 6).

Consult "Precautions" before use, installation or service of MAC Valves.

**TECHNICAL
DATA**

Fluid :	Compressed air, vacuum, inert gases		
Pressure range :	Internal pilot : 20 - 150 PSI External pilot : vacuum to 150 PSI		
Pilot pressure :	20 - 150 PSI		
Lubrication :	Not required, if used select a medium aniline point lubricant (between 180°F to 210°F)		
Filtration :	40 µ		
Temperature range :	0°F to 120°F (-18°C to +50°C)		
Orifice :	7.3 mm		
Flow :	50 cm ³ /min		
Coil :	General purpose class A, continuous duty, encapsulated		
Voltage range :	-15% to +10% of nominal voltage		
Protection :	NEMA 4		
Power :	~ Inrush : 10.9 VA Holding : 7.7 VA = 1.8 to 12.7 W		
Response times :	24 V=5.4 W	Energize : 7.3 ms	De-energize : 5.3ms
	60Hz/6 W	Energize : 8-12 ms	De-energize : 7-11 ms

- Spare parts : • Pilot valve : DMB-DXXX-XXX-1, including mounting screws 35043 and seal 16524.
- Accessories • Blanking plate : M-52003. • Seal (x3) : 17013-01. • Mounting screw (x2) : 35043.
- Options : • BSPP threads. • Isolation of inlet and/or exhaust.

DIMENSIONS

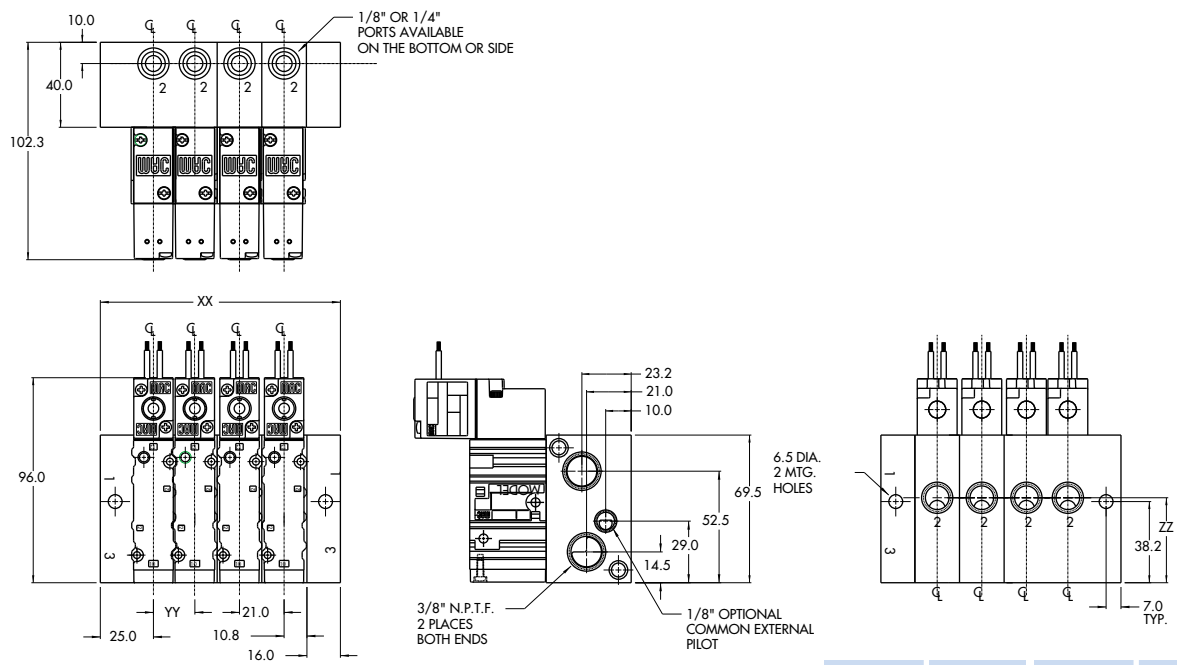

YY	XX	PORT	ZZ
19.5	113	1/8"	36.0
26	119.5	1/4"	40.0

Note: Bottom & side cylinder ports not available on the same station



Section 2

Options



0 p t i o n s

Codification table for voltages / Wire length / Manual operator / Electrical connection

VALVE CODE ➤

DM-DXX X - X XX
1 2 3 4

OPTIONS AVAILABLE FOR

- pilot operated valves 400, 52 & 92 Series

1. VOLTAGE

- D XX	X - X XX	VOLTAGE
<input type="radio"/>	DB	12 VDC (5.4 W)
<input type="radio"/>	DC	12 VDC (7.5 W)
<input type="radio"/>	DD	24 VDC (7.3 W)
<input type="radio"/>	DE	12 VDC (12.7 W)
<input type="radio"/>	DK	110 VDC (5.8 W)
<input type="radio"/>	DJ	28 VDC (5.7 W)
<input type="radio"/>	DL	64 VDC (6.0 W)
<input type="radio"/>	DM	36 VDC (5.8 W)
<input type="radio"/>	DN	6 VDC (6.0 W)
<input type="radio"/>	DR	90 VDC (6.6 W)
<input type="radio"/>	DS	110 VDC (7.3 W), 100 VDC (6.0 W)
<input type="radio"/>	DT	75 VDC (5.6 W)
<input type="radio"/>	DP	48 VDC (5.8 W)
<input type="radio"/>	FA	12 VDC (1.8 W)
<input type="radio"/>	FE	12 VDC (2.4 W)
<input type="radio"/>	FF	24 VDC (2.4 W)
<input type="radio"/>	JD	100/60, 100/50, 110/60

2. WIRE LENGTH

- D XX	X - X XX	WIRE LENGTH
<input type="radio"/>	B	24"
<input type="radio"/>	C	36"
<input type="radio"/>	D	48"
<input type="radio"/>	E	72"
<input type="radio"/>	F	96"



3. MANUAL OPERATOR

- D XX X - X XX	MANUAL OPERATOR
<input type="radio"/> 0	No operator
<input type="radio"/> 1	Non-locking recessed
<input type="radio"/> 2	Locking recessed
<input type="radio"/> 3	Non-locking extended
<input type="radio"/> 4	Locking extended

4. ELECTRICAL CONNECTION

- D XX X - X XX	ELECTRICAL CONNECTION
<input type="radio"/> BA	Flying leads
<input type="radio"/> BK	BA with protection diode
<input type="radio"/> BL	BA with protection varistor
<input type="radio"/> CA	1/2" NPS conduit
<input type="radio"/> JB	Rectangular connector
<input type="radio"/> JD	Rectangular connector with light
<input type="radio"/> JM	Rectangular connector, male only
<input type="radio"/> KA	Square connector
<input type="radio"/> KB	Square connector with protection diode
<input type="radio"/> KC	Square connector with protection varistor
<input type="radio"/> KD	Square connector with light
<input type="radio"/> KE	Square connector with light and protection diode
<input type="radio"/> KF	Square connector with light and protection varistor
<input type="radio"/> KJ	Square connector (male only)
<input type="radio"/> KK	Square connector with protection diode (male only)
<input type="radio"/> KL	Square connector with protection varistor (male only)
<input type="radio"/> TA	Dual tabs
<input type="radio"/> TB	TA with protection diode
<input type="radio"/> TD	TA with light
<input type="radio"/> TE	TA with light and protection diode
<input type="radio"/> TJ	Dual tabs (male only)
<input type="radio"/> TK	TJ with protection diode
<input type="radio"/> TM	TJ with light
<input type="radio"/> TN	TJ with light and protection diode
<input type="radio"/> *DN	Plug-in with diode
<input type="radio"/> *DP	Plug-in with M.O.V.
<input type="radio"/> *DH	Plug-in with diode & ground
<input type="radio"/> *DJ	Plug-in with M.O.V & ground

* These options only apply to the 92 series. All others are for the 400 and 52 series.

MOD. S009

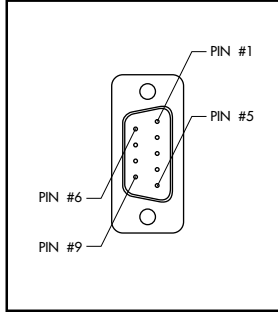

TECHNICAL DATA

- Type «SUB_D»
- Number of contacts : 9
- Solder termination (Dia. 0.6 mm/0.14 mm²/26-22 AWG)
- Operating current 5 A/contact
- Rated voltage 125 V~
- Temp. range -40° to +125°C
- Insulation resistance ≥ 5.0⁹ Ω
- Protection class IP40 (DIN 40050)
- Number of solenoids : 7 max.
- Max. 24 V=/5.4 W per solenoid
- 2 common wires

MOD. S015

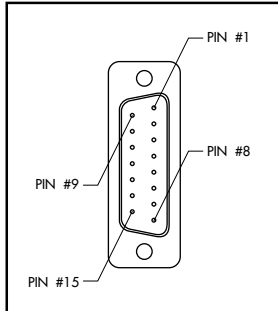

TECHNICAL DATA

- Type «SUB_D»
- Number of contacts : 15
- Solder termination (Dia. 0.6 mm/0.14 mm²/26-22 AWG)
- Operating current 5 A/contact
- Rated voltage 125 V~
- Temp. range -40° to +125°C
- Insulation resistance ≥ 5.0⁹ Ω
- Protection class IP40 (DIN 40050)
- Number of solenoids : 12 max.
- Max. 24 V=/5.4 W per solenoid
- 3 common wires

MOD. S025

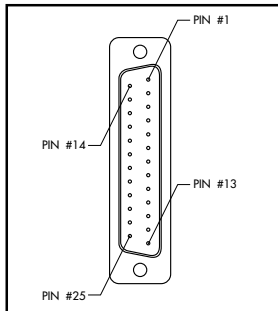

TECHNICAL DATA

- Type «SUB_D»
- Number of contacts : 25
- Solder termination (Dia. 0.6 mm/0.14 mm²/26-22 AWG)
- Operating current 5 A/contact
- Rated voltage 125 V~
- Temp. range -40° to +125°C
- Insulation resistance ≥ 5.0⁹ Ω
- Protection class IP40 (DIN 40050)
- Number of solenoids : 20 max.
- Max. 24 V=/5.4 W per solenoid
- 5 common wires

Note : Use desired MOD. number after circuit bar part number

Connector termination details

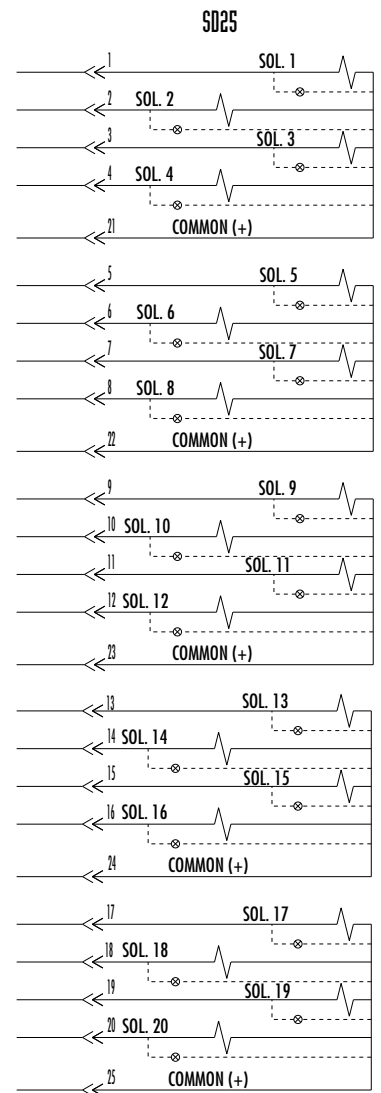
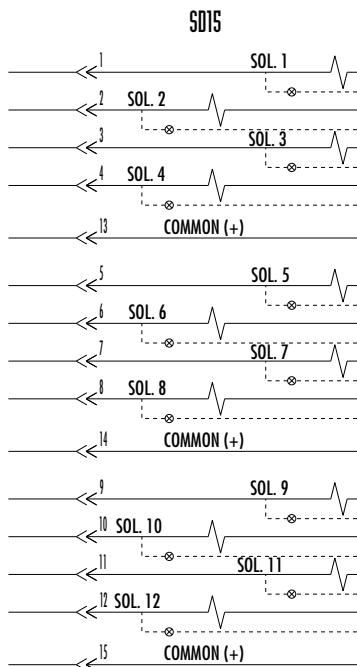
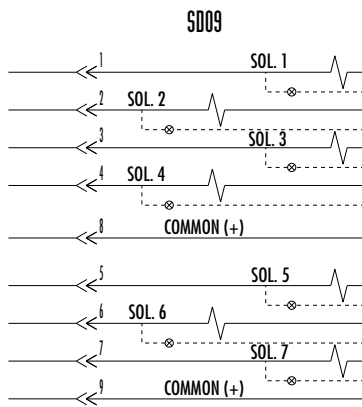
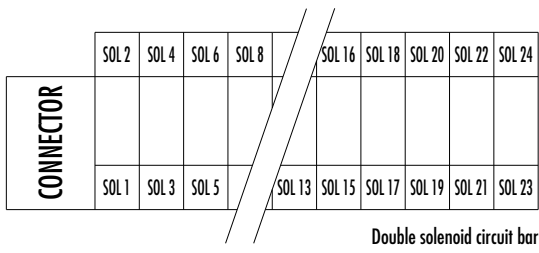
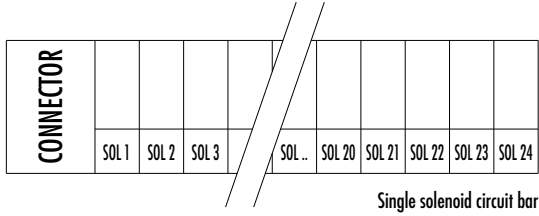

Circuit bar mounting

non plug-in cylinder ports in base	non plug-in cylinder ports in valve	plug-in	plug-in with F. C.	plug-in with Pr. Reg.	plug-in with Pr. Reg. and F. C.	add-on style plug-in	add-on style plug-in with F. C.
add-on style plug-in with Pr. Reg.	add-on style plug-in with Pr. Reg. and F. C.	plug-in add-a-unit stations	plug-in add-a-unit stations with F. C.	plug-in add-a-unit stations with Pr. Reg.	plug-in add-a-unit stations with F. C. and Pr. Reg.	plug-in with pre-wired connector	plug-in with F. C. and pre-wired connector
plug-in with Pr. Reg. and pre-wired connector	din rail, plug-in with pre-wired connector						

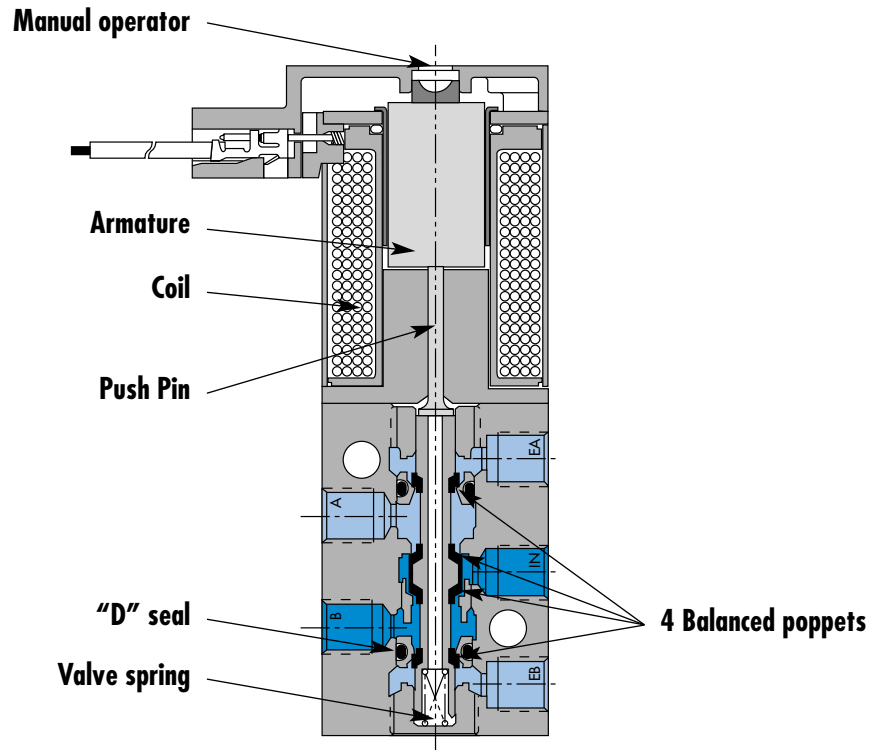

SERIES FEATURES

- High force MACSOLENOID®.
- 10mm direct operated.
- # 10-32 or M5 ports.
- Rated for lubricated or non-lubricated service.
- Cylinder ports in valve or in circuit bar.

Function	Port size	Flow [Max]	Circuit bar mounting
5/2, 3/2 NO-NC	M5 - #10-32	0.093C_v	non plug-in cylinder ports in base

OPERATIONAL BENEFITS

1. 10 mm valve, direct solenoid operated.
2. Balanced poppet, immune to variations of pressure.
3. Short stroke with high flow.
4. The patented solenoid develops high shifting forces.
5. Powerful return spring.
6. Flow is specifically adjusted on each valve.
7. Manual operator standard on all valves.

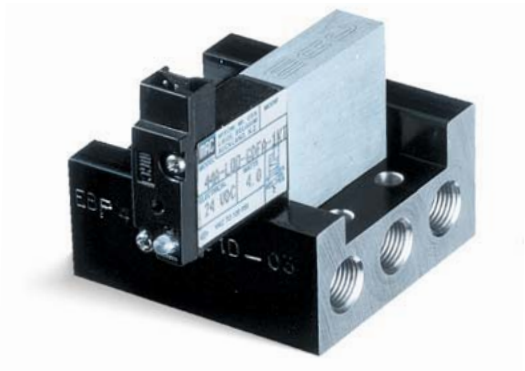

Reset



HOW TO ORDER

44B-xxx-Gxxx-xxx

HOW TO ORDER VALVE FOR CIRCUIT BAR MOUNTING

Port size (see base)	Valve	Valve for use with external flow controls
		
Valve less base	<input type="radio"/> 44B-100-Gxxx-xxx	<input type="radio"/> 44B-M00-Gxxx-xxx

SOLENOID OPERATOR >

G **XX X- X XX**

XX Voltage	X Wire length	X Manual operator	XX Electrical connection
<input type="radio"/> DA 24VDC (1.0 W)	<input type="radio"/> A 18"	<input type="radio"/> 1 Non-locking	<input type="radio"/> BA Flying leads
<input type="radio"/> DC 24VDC (1.8 W)	<input type="radio"/> C 36"		<input type="radio"/> BT Flying leads with light
<input type="radio"/> DD 24VDC (2.5 W)	<input type="radio"/> x Other Options		<input type="radio"/> KA Mini connector
<input type="radio"/> DF 24VDC (4.0 W)			<input type="radio"/> KT Mini connector with light
<input type="radio"/> xx Other Options			<input type="radio"/> xx Other Options

EBP44B-xxxx-xx

HOW TO ORDER CIRCUIT BAR

Port size	Side cylinder ports	Bottom cylinder ports
M5	<input type="radio"/> EBP44B-001D-xx	<input type="radio"/> EBP44B-002D-xx
# 10-32	<input type="radio"/> EBP44B-001B-xx	<input type="radio"/> EBP44B-002B-xx

Number of stations (03=3 stations)

Note : clic for valves mounted on base at the factory (add - 9 to the model number).

**TECHNICAL
DATA**

Fluid :	Compressed air, vacuum, inert gases
Pressure range :	Vacuum to 120 PSI
Lubrication :	Not required, if used select a medium aniline point lubricant (between 180°F and 210°F)
Filtration :	40 µ
Temperature range :	0°F to 120°F (-18°C to +50°C)
Orifice :	1.8 mm
Flow (at 6 bar, ΔP=1bar) :	4 W : 0.093 C _v , 2.5 W : 0.077 C _v , 1,8 W : 0.057 C _v , 1.0 W : 0.048 C _v
Coil :	General purpose class A, continuous duty, encapsulated
Voltage range :	-15% to +10% of nominal voltage
Power :	4 W - 2.5 W - 1.8 W - 1.0 W
Response times :	Energize : 3.4 ms
(with 4 W coil)	De-energize : 1.5 ms

- Note : • Valve and coil are not interchangeable.
- Spare parts : • Valve mounting kit : N-44001-03. • Blanking plate : M-44003.
- Options : • Isolation of inlet and/or exhaust. Special bar. Consult Factory.

DIMENSIONS

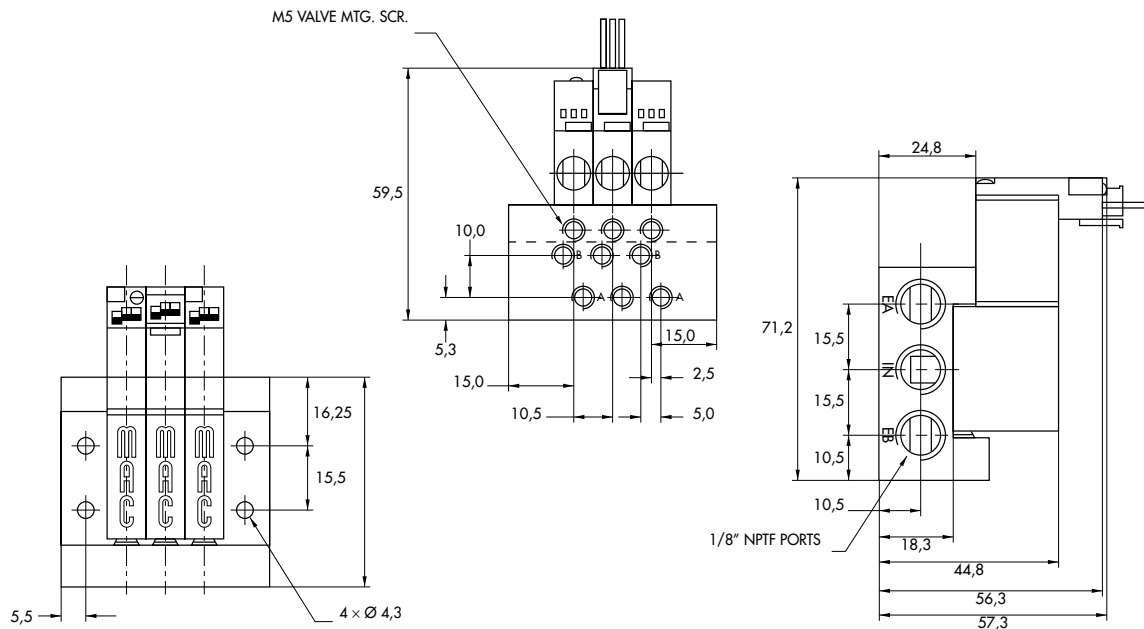

Function	Port size (Inlet & Exhaust)	Flow (Max)	Circuit bar mounting
5/2, 3/2 NO-NC	# 10-32 - 1/8"	0.093C_v	non plug-in cylinder ports in valve

OPERATIONAL BENEFITS

1. 10 mm valve, direct solenoid operated.
2. Balanced poppet, immune to variations of pressure.
3. Short stroke with high flow.
4. The patented solenoid develops high shifting forces.
5. Powerful return spring.
6. Flow is specifically adjusted on each valve.
7. Manual operator standard on all valves.

Reset



HOW TO ORDER

44B-xxx-Gxxx-xxx

HOW TO ORDER VALVE FOR CIRCUIT BAR MOUNTING

Valve port size	Valve	Valve for use with external flow controls
M5	<input type="radio"/> 44B-ABA-Gxxx-xxx	<input type="radio"/> 44B-BBA-Gxxx-xxx
# 10-32	<input type="radio"/> 44B-AAA-Gxxx-xxx	<input type="radio"/> 44B-BAA-Gxxx-xxx

SOLENOID OPERATOR >

G XX X- X XX*

XX Voltage	X Wire length	X Manual operator	XX Electrical connection
<input type="radio"/> DA 24VDC (1.0 W)	<input type="radio"/> A 18"	<input type="radio"/> I Non-locking	<input type="radio"/> BA Flying leads
<input type="radio"/> DC 24VDC (1.8 W)	<input type="radio"/> c 36"		<input type="radio"/> BT Flying leads with light
<input type="radio"/> DD 24VDC (2.5 W)	<input type="radio"/> x Other Options		<input type="radio"/> KA Mini connector
<input type="radio"/> DF 24VDC (4.0 W)			<input type="radio"/> KT Mini connector with light
<input type="radio"/> xx Other Options			<input type="radio"/> xx Other Options

EBM44A-xxxx-xx

HOW TO ORDER CIRCUIT BAR

Port size COMMON INLET & EXHAUST	
# 10-32	<input type="radio"/> EBM44A-001B-xx
1/8" NPTF	<input type="radio"/> EBM44A-002A-xx

Number of stations (03=3 stations)

Note: clic for valves mounted on base at the factory (add - 9 to the model number).

**TECHNICAL
DATA**

Fluid :	Compressed air, vacuum, inert gases
Pressure range :	Vacuum to 120 PSI
Lubrication :	Not required, if used select a medium aniline point lubricant (between 180°F and 210°F)
Filtration :	40 µ
Temperature range :	0°F to 120°F (-18°C to +50°C)
Orifice :	1.8 mm
Flow (at 6 bar, ΔP=1bar) :	4 W : 0.093 C _v , 2.5 W : 0.077 C _v , 1,8 W : 0.057 C _v , 1.0 W : 0.048 C _v
Coil :	General purpose class A, continuous duty, encapsulated
Voltage range :	-15% to +10% of nominal voltage
Power :	4 W - 2.5 W - 1.8 W - 1.0 W
Response times :	Energize : 3.5 ms
(with 4 W coil)	De-energize : 1.5 ms

- Note : • Valve and coil are not interchangeable.
- Spare parts : • Valve mounting kit (M5) : M-44001-21. • Valve mounting kit (1/8") : M-44001-01. • Blanking plate : 30426-A.
- Options : • Isolation of inlet and/or exhaust. Special bar. Consult Factory.

DIMENSIONS

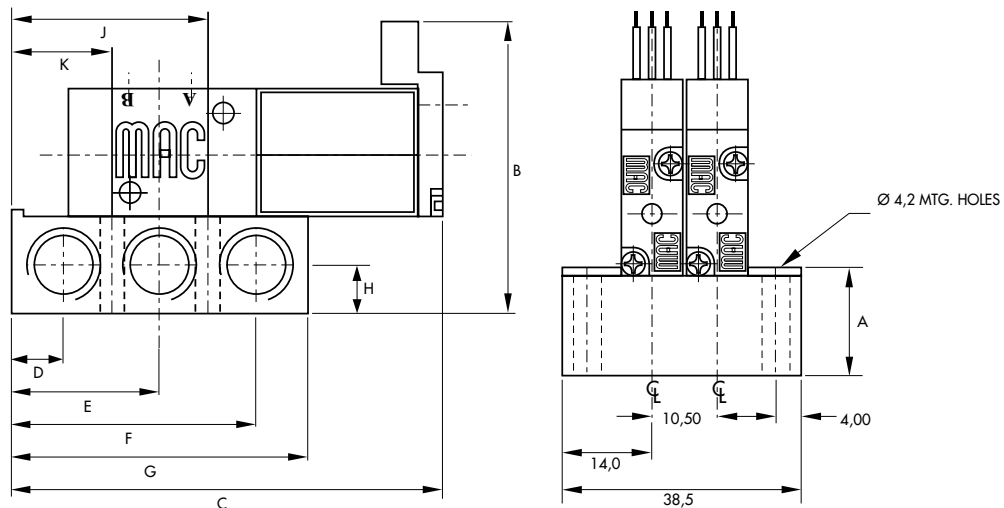

Port size	A	B	C	D	E	F	G	H	J	K
1/8"	16.0	47.5	69.2	8.5	24.0	39.5	48.0	8.0	31.85	16.15
M5	12.0	43.5	63.2	5.0	17.0	29.0	34.0	6.0	23.00	11.00

Function	Port size	Flow [Max]	Circuit bar mounting
5/2, 3/2 NO-NC	M5 - #10-32	0.09C_v	plug-in

OPERATIONAL BENEFITS

1. 10 mm valve, direct solenoid operated.
2. Balanced poppet, immune to variations of pressure.
3. Short stroke with high flow.
4. The patented solenoid develops high shifting forces.
5. Powerful return spring.
6. Flow is specifically adjusted on each valve.
7. Manual operator standard on all valves.

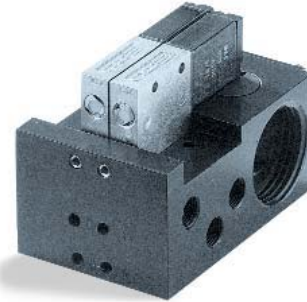

HOW TO ORDER

44B-xxx-GxxO-xxx

HOW TO ORDER VALVE FOR CIRCUIT BAR MOUNTING

Port size (see base)	Single operator
Valve less base	 <input type="radio"/> 44B-LOO-GxxO-xxx

SOLENOID OPERATOR >

G XX O - X XX*

XX Voltage	X Manual operator	XX Electrical connection
<input type="radio"/> DA 24VDC (1.0 W)	<input type="radio"/> 1 Non-locking	<input type="radio"/> DJ Plug-in
<input type="radio"/> DC 24VDC (1.8 W)		<input type="radio"/> DT Plug-in with light
<input type="radio"/> DD 24VDC (2.5 W)		<input type="radio"/> DE Plug-in with suppression diode
<input type="radio"/> DF 24VDC (4.0 W)		<input type="radio"/> DV Plug-in with light and suppression diode
<input type="radio"/> xx Other Options		<input type="radio"/> xx Other Options

ECD044B-00xxx-AOxx

HOW TO ORDER CIRCUIT BAR

Port size	Side cylinder ports (10.5 mm)	Bottom cylinder ports (10.5 mm)
M5	<input type="radio"/> ECD044B-001AD-AOxx	<input type="radio"/> ECD044B-002AD-AOxx
# 10-32	<input type="radio"/> ECD044B-001AB-AOxx	<input type="radio"/> ECD044B-002AB-AOxx

Number of stations (03=3 stations)

Note : clic for valves mounted on base at the factory (add - 9 to the model number).
 clic for multi-pin connector option (9, 15 or 25).

**TECHNICAL
D A T A**

Fluid :	Compressed air, vacuum, inert gases
Pressure range :	Vacuum to 120 PSI
Lubrication :	Not required, if used select a medium aniline point lubricant (between 180°F and 210°F)
Filtration :	40 µ
Temperature range :	0°F to 120°F (-18°C to +50°C)
Orifice :	1.8 mm
Flow (at 6 bar, ΔP=1bar) :	4 W : 0.09 C _v , 2.5 W : 0.08 C _v , 1.8 W : 0.06 C _v , 1.0 W : 0.05 C _v
Coil :	General purpose class A, continuous duty, encapsulated
Voltage range :	-15% to +10% of nominal voltage
Power :	4 W - 2.5 W - 1.8 W - 1.0 W
Response times :	Energize : 4 ms
(with 4 W coil)	De-energize : 1.5 ms

- Note : • Valve and coil are not interchangeable.
- Spare parts : • Valve mounting kit : N-44001-03. • Blanking plate : M-44003.
- Options : • Isolation of inlet and/or exhaust. • BSPP Threads.

D I M E N S I O N S

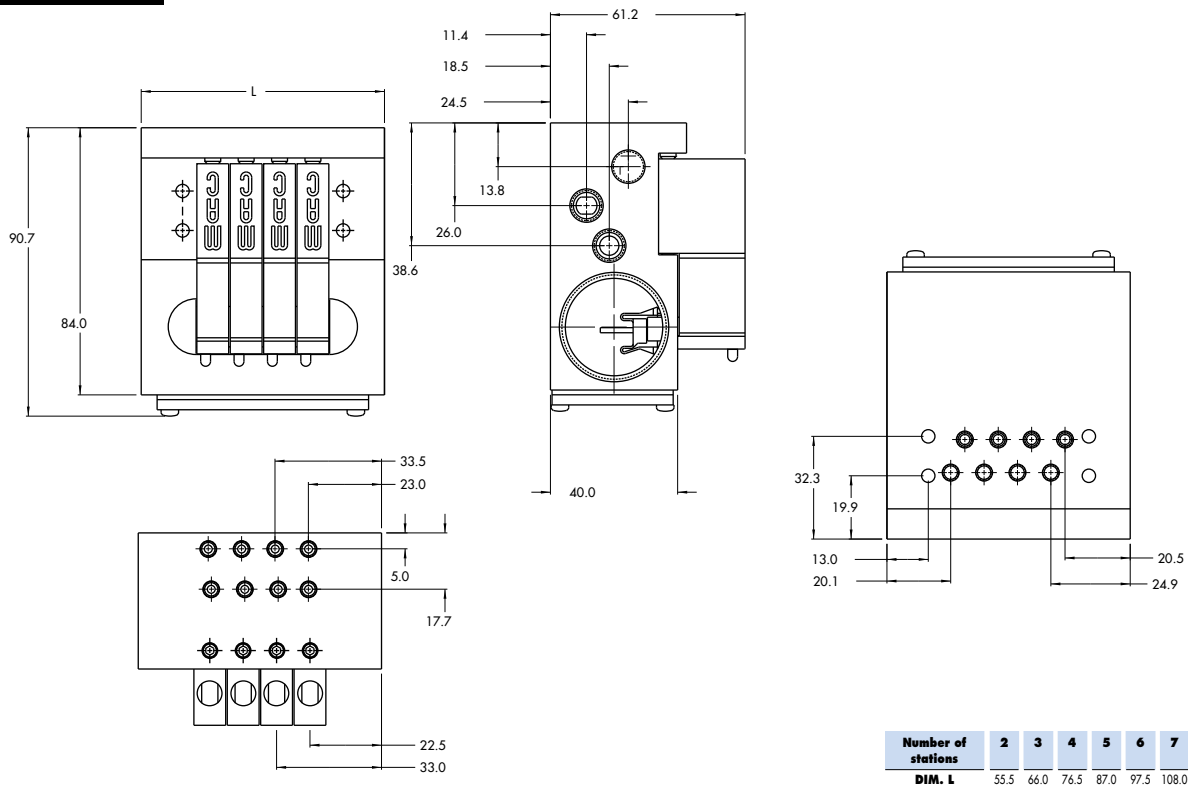

Function	Port size	Flow [Max]	Circuit bar mounting
5/2, 3/2 NO-NC	M5 - #10-32	0.08C_v	plug-in with F. C.

OPERATIONAL BENEFITS

1. 10 mm valve, direct solenoid operated.
2. Balanced poppet, immune to variations of pressure.
3. Short stroke with high flow.
4. The patented solenoid develops high shifting forces.
5. Powerful return spring.
6. Flow is specifically adjusted on each valve.
7. Manual operator standard on all valves.

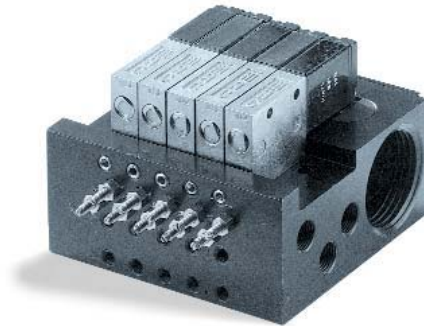

HOW TO ORDER

44B-xxx-GxxO-xxx

HOW TO ORDER VALVE FOR CIRCUIT BAR MOUNTING

Port size (see base)	Single operator
Valve less base	 <input type="radio"/> 44B-MOO-GxxO-xxx

SOLENOID OPERATOR >

G XX O - X XX*

XX Voltage	X Manual operator	XX Electrical connection
<input type="radio"/> DA 24VDC (1.0 W)	<input type="radio"/> 1 Non-locking	<input type="radio"/> DJ Plug-in
<input type="radio"/> DC 24VDC (1.8 W)		<input type="radio"/> DT Plug-in with light
<input type="radio"/> DD 24VDC (2.5 W)		<input type="radio"/> DE Plug-in with suppression diode
<input type="radio"/> DF 24VDC (4.0 W)		<input type="radio"/> DV Plug-in with light and suppression diode
<input type="radio"/> xx Other Options		<input type="radio"/> xx Other Options

ECD044B-00xxx-AOxx

HOW TO ORDER CIRCUIT BAR WITH FLOW CONTROLS

Port size	Side cylinder ports (10.5 mm)	Bottom cylinder ports (10.5 mm)
M5	<input type="radio"/> ECD044B-005AD-AOxx	<input type="radio"/> ECD044B-006AD-AOxx
# 10-32	<input type="radio"/> ECD044B-005AB-AOxx	<input type="radio"/> ECD044B-006AB-AOxx

Number of stations (03=3 stations)

Note : clic for valves mounted on base at the factory (add - 9 to the model number).
 clic for multi-pin connector option (9, 15 or 25).

**TECHNICAL
DATA**

Fluid :	Compressed air, vacuum, inert gases
Pressure range :	Vacuum to 120 PSI
Lubrication :	Not required, if used select a medium aniline point lubricant (between 180°F and 210°F)
Filtration :	40 µ
Temperature range :	0°F to 120°F (-18°C to +50°C)
Orifice :	1.8 mm
Flow (at 6 bar, ΔP=1bar) :	4 W : 0.09 C _v , 2.5 W : 0.08 C _v , 1.8 W : 0.06 C _v , 1.0 W : 0.05 C _v
Coil :	General purpose class A, continuous duty, encapsulated
Voltage range :	-15% to +10% of nominal voltage
Power :	4 W - 2.5 W - 1.8 W - 1.0 W
Response times :	Energize : 4 ms
(with 4 W coil)	De-energize : 1.5 ms

- Note :
 - Valve and coil are not interchangeable.
- Spare parts :
 - Valve mounting kit : N-44001-03. • Blanking plate : M-44003. • Flow control needle (x2): N-44002.
 - Base wire Plug-in protector : 24180.
- Options :
 - Isolation of inlet and/or exhaust. • BSPP Threads.

DIMENSIONS

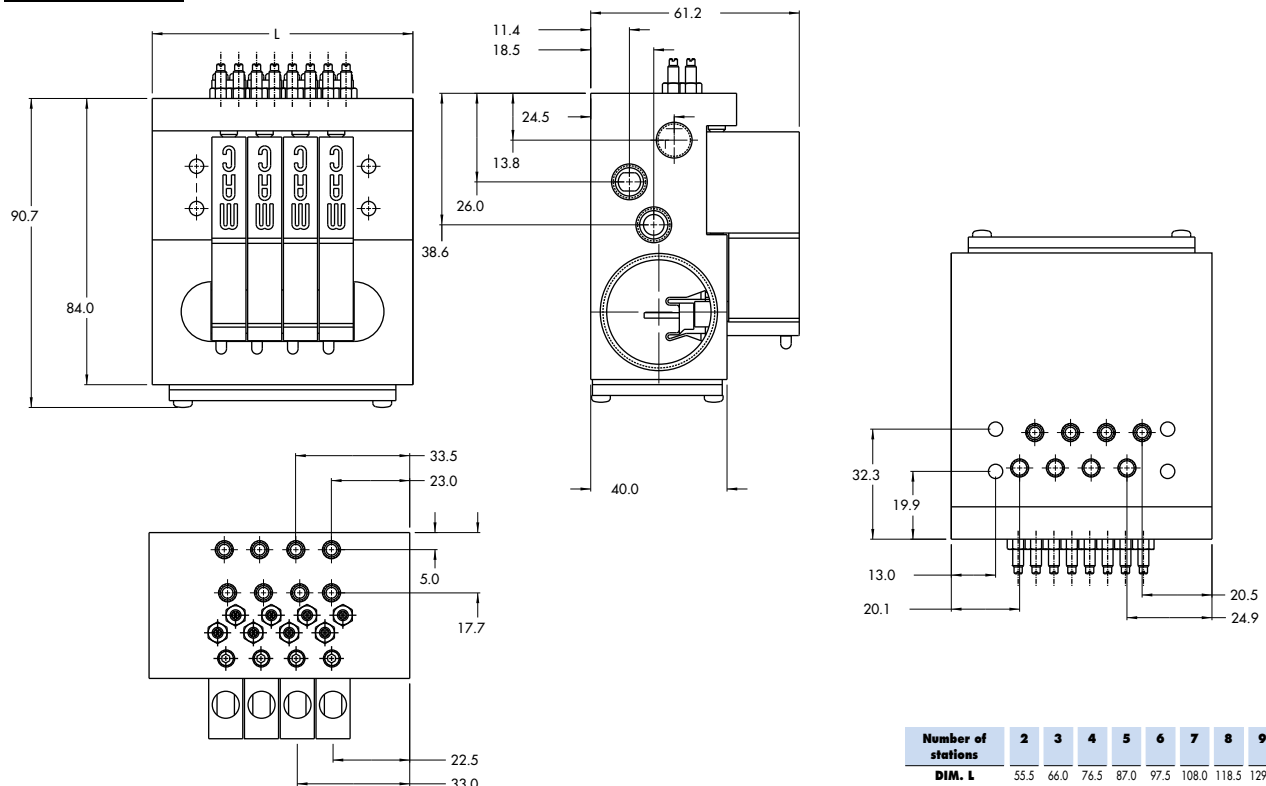

Consult "Precautions" before use, installation or service of MAC Valves.

Function	Port size	Flow [Max]	Circuit bar mounting
5/2, 3/2 NO-NC	M5 - #10-32	0.08C_v	plug-in with Pr. Reg.

OPERATIONAL BENEFITS

1. 10 mm valve, direct solenoid operated.
2. Balanced poppet, immune to variations of pressure.
3. Short stroke with high flow.
4. The patented solenoid develops high shifting forces.
5. Powerful return spring.
6. Flow is specifically adjusted on each valve.
7. Manual operator standard on all valves.

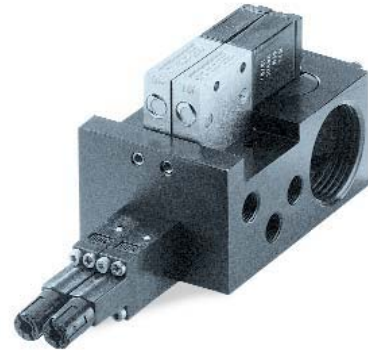

HOW TO ORDER

44B-xxx-GxxO-xxx

HOW TO ORDER VALVE FOR CIRCUIT BAR MOUNTING

Port size (see base)	Single operator
Valve less base	 <input type="radio"/> 44B-LOO-GxxxO-xxx

SOLENOID OPERATOR >

G **XX** O- X **XX***

XX Voltage	X Manual operator	XX Electrical connection
<input type="radio"/> DA 24VDC (1.0 W)	<input type="radio"/> 1 Non-locking	<input type="radio"/> DJ Plug-in
<input type="radio"/> DC 24VDC (1.8 W)		<input type="radio"/> DT Plug-in with light
<input type="radio"/> DD 24VDC (2.5 W)		<input type="radio"/> DE Plug-in with suppression diode
<input type="radio"/> DF 24VDC (4.0 W)		<input type="radio"/> DV Plug-in with light and suppression diode
<input type="radio"/> xx Other Options		<input type="radio"/> xx Other Options

ECD044B-00xxx-AOxx

HOW TO ORDER CIRCUIT BAR FOR PRESSURE REGULATORS** (to be ordered separately)

Port size	Bottom cylinder ports (10,5 mm)
M5	<input type="radio"/> ECD044B-004AD-AO-xx
# 10-32	<input type="radio"/> ECD044B-004AB-AO-xx

Number of stations (03=3 stations)

Note : clic for valves mounted on base at the factory (add - 9 to the model number).
 clic for multi-pin connector option (9, 15 or 25).

** Pressure Regulators :

- PR44A-AOxx**
- Y=A (no gage port)
 - Y=B (with gage port)
 - X=A (0 to 100 PSI)
 - X=B (0 to 60 PSI)
 - X=C (0 to 40 PSI)
 - X=D (0 to 15 PSI)

**TECHNICAL
DATA**

Fluid :	Compressed air, vacuum, inert gases
Pressure range :	Vacuum to 120 PSI
Lubrication :	Not required, if used select a medium aniline point lubricant (between 180°F and 210°F)
Filtration :	40 µ
Temperature range :	0°F to 120°F (-18°C to +50°C)
Orifice :	1.8 mm
Flow (at 6 bar, ΔP=1bar) :	4 W : 0.09 C _v , 2.5 W : 0.08 C _v , 1.8 W : 0.06 C _v , 1.0 W : 0.05 C _v
Coil :	General purpose class A, continuous duty, encapsulated
Voltage range :	-15% to +10% of nominal voltage
Power :	4 W - 2.5 W - 1.8 W - 1.0 W
Response times :	Energize : 4 ms
(with 4 W coil)	De-energize : 1.5 ms

- Note :
- Valve and coil are not interchangeable.
 - Pressure range regulators : (0-100 PSI).
- Spare parts :
- Valve mounting kit : N-44001-03. • Blanking plate : M-44003. • Blanking plate regulator: N-44003.
 - Base wire Plug-in protector : 24180.
- Options :
- Isolation of inlet and/or exhaust. • BSPP Threads.

DIMENSIONS

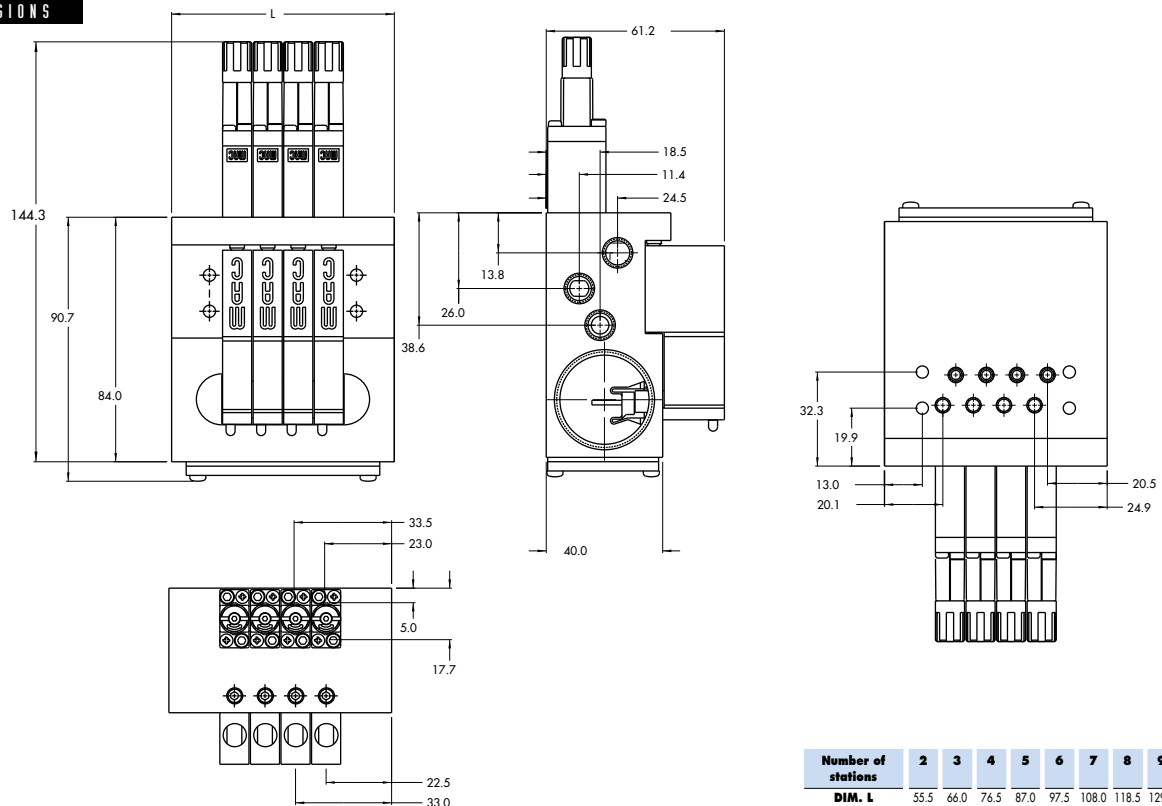

Consult "Precautions" before use, installation or service of MAC Valves.

Function	Port size	Flow [Max]	Circuit bar mounting
5/2, 3/2 NO-NC	M5 - #10-32	0.07C_v	plug-in with Pr. Reg. and F. C.

OPERATIONAL BENEFITS

1. 10 mm valve, direct solenoid operated.
2. Balanced poppet, immune to variations of pressure.
3. Short stroke with high flow.
4. The patented solenoid develops high shifting forces.
5. Powerful return spring.
6. Flow is specifically adjusted on each valve.
7. Manual operator standard on all valves.

Reset

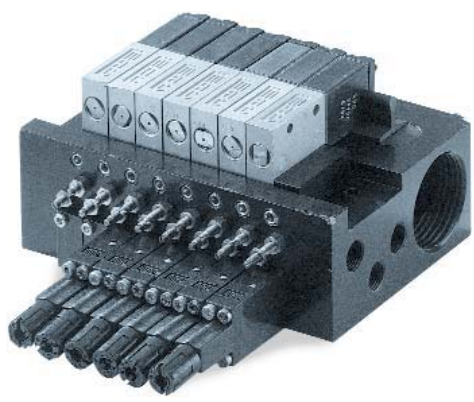

HOW TO ORDER

44B-xxx-GxxO-xxx

HOW TO ORDER VALVE FOR CIRCUIT BAR MOUNTING

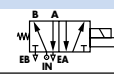
Port size (see base)	Single operator
Valve less base	 <input type="radio"/> 44B-MOO-GxxO-xxx

SOLENOID OPERATOR >

G XX O- X XX		
XX Voltage	X Manual operator	XX Electrical connection
<input type="radio"/> DA 24VDC (1.0 W)	<input type="radio"/> 1 Non-locking	<input type="radio"/> DJ Plug-in
<input type="radio"/> DC 24VDC (1.8 W)		<input type="radio"/> DT Plug-in with light
<input type="radio"/> DD 24VDC (2.5 W)		<input type="radio"/> DE Plug-in with suppression diode
<input type="radio"/> DF 24VDC (4.0 W)		<input type="radio"/> DV Plug-in with light and suppression diode
<input type="radio"/> xx Other Options		<input type="radio"/> xx Other Options

ECD044B-00xxx-AOxx

HOW TO ORDER CIRCUIT BAR WITH FLOW CONTROLS AND PRESSURE REGULATORS** (pressure regulators to be ordered separately)

Port size	Bottom cylinder ports (10,5 mm)
M5	<input type="radio"/> ECD044B-007AD-AO-xx
# 10-32	<input type="radio"/> ECD044B-007AB-AO-xx

Number of stations (03=3 stations)

Note : clic for valves mounted on base at the factory (add - 9 to the model number).
 clic for multi-pin connector option (9, 15 or 25).

PR44A-AOxx

- ** Pressure Regulators :
- Y=A (no gage port)
 - Y=B (with gage port)
 - X=A (0 to 100 PSI)
 - X=B (0 to 60 PSI)
 - X=C (0 to 40 PSI)
 - X=D (0 to 15 PSI)

**TECHNICAL
DATA**

Fluid :	Compressed air, vacuum, inert gases
Pressure range :	Vacuum to 120 PSI
Lubrication :	Not required, if used select a medium aniline point lubricant (between 180°F and 210°F)
Filtration :	40 µ
Temperature range :	0°F to 120°F (-18°C to +50°C)
Orifice :	1.8 mm
Flow (at 6 bar, ΔP=1bar) :	4 W : 0.07 C _v , 2.5 W : 0.06 C _v , 1.8 W : 0.06 C _v , 1.0 W : 0.05 C _v
Coil :	General purpose class A, continuous duty, encapsulated
Voltage range :	-15% to +10% of nominal voltage
Power :	4 W - 2.5 W - 1.8 W - 1.0 W
Response times :	Energize : 4 ms
(with 4 W coil)	De-energize : 1.5 ms

- Note :
- Valve and coil are not interchangeable.
 - Pressure range regulators : (0-100 PSI).
- Spare parts :
- Valve mounting kit : N-44001-03. • Blanking plate : M-44003. • Blanking plate regulator: N-44003.
 - Base wire Plug-in protector : 24180.
- Options :
- Isolation of inlet and/or exhaust. • BSPP Threads.

DIMENSIONS

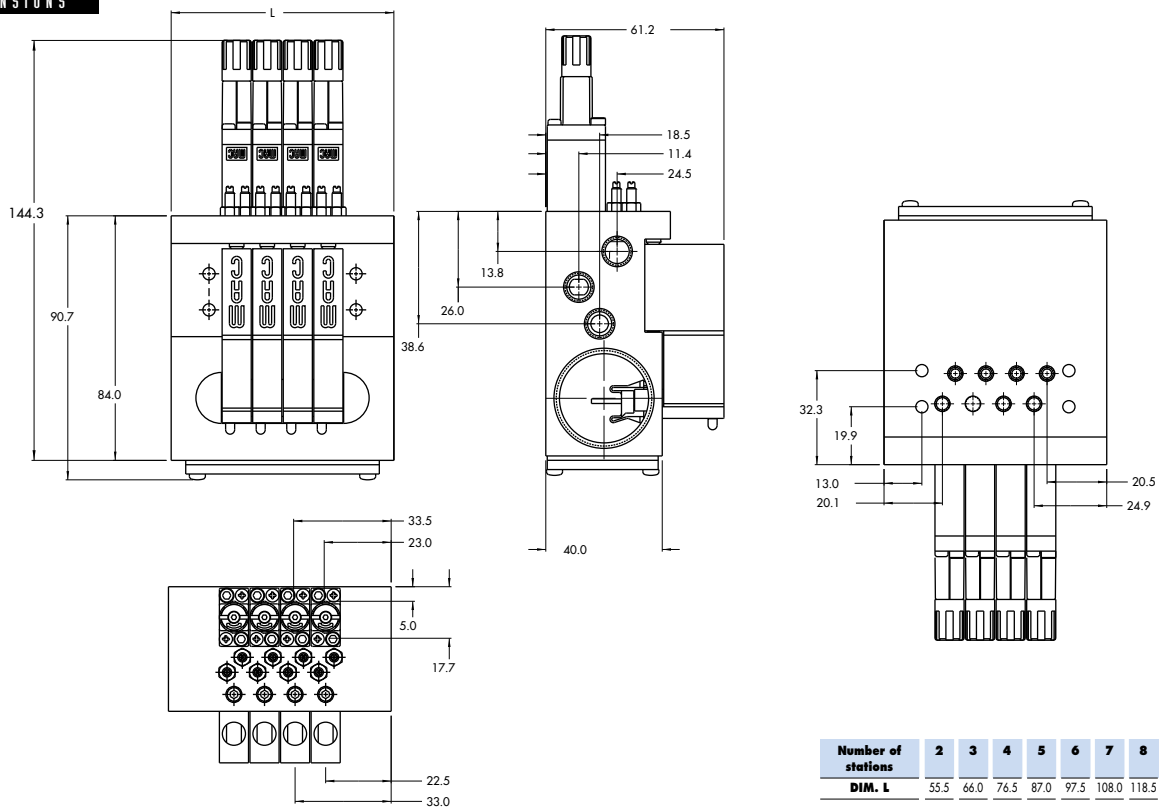

Consult "Precautions" before use, installation or service of MAC Valves.

Function	Port size	Flow [Max]	Circuit bar mounting
5/2, 3/2 NO-NC	M5 - #10-32	0.09C_v	add-on style plug-in

OPERATIONAL BENEFITS

1. 10 mm valve, direct solenoid operated.
2. Balanced poppet, immune to variations of pressure.
3. Short stroke with high flow.
4. The patented solenoid develops high shifting forces.
5. Powerful return spring.
6. Flow is specifically adjusted on each valve.
7. Manual operator standard on all valves.

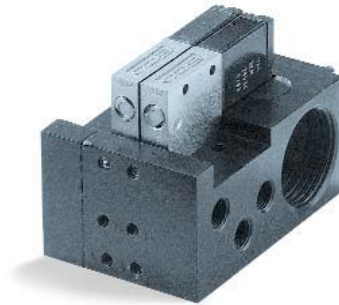

HOW TO ORDER

44B-xxx-GxxO-xxx

HOW TO ORDER VALVE FOR CIRCUIT BAR MOUNTING

Port size (see base)	Single operator
Valve less base	 <input type="radio"/> 44B-LOO-GxxO-xxx

SOLENOID OPERATOR >

G **XX** O- **X** **XX***

XX Voltage	X Manual operator	XX Electrical connection
<input type="radio"/> DA 24VDC (1.0 W)	<input type="radio"/> 1 Non-locking	<input type="radio"/> DJ Plug-in
<input type="radio"/> DC 24VDC (1.8 W)		<input type="radio"/> DT Plug-in with light
<input type="radio"/> DD 24VDC (2.5 W)		<input type="radio"/> DE Plug-in with suppression diode
<input type="radio"/> DF 24VDC (4.0 W)		<input type="radio"/> DV Plug-in with light and suppression diode
<input type="radio"/> xx Other Options		<input type="radio"/> xx Other Options

ECD044B-00xxx-AOxx

HOW TO ORDER CIRCUIT BAR

Port size	Side cylinder ports (10.5 mm)	Bottom cylinder ports (10.5 mm)
M5	<input type="radio"/> ECD044B-001BD-AOxx	<input type="radio"/> ECD044B-002BD-AOxx
# 10-32	<input type="radio"/> ECD044B-001BB-AOxx	<input type="radio"/> ECD044B-002BB-AOxx

Number of stations (03=3 stations)

Note : clic for valves mounted on base at the factory (add - 9 to the model number).
 clic for multi-pin connector option (9, 15 or 25).
 add-a-unit stations may be added to above bars.

**TECHNICAL
DATA**

Fluid :	Compressed air, vacuum, inert gases
Pressure range :	Vacuum to 120 PSI
Lubrication :	Not required, if used select a medium aniline point lubricant (between 180°F and 210°F)
Filtration :	40 µ
Temperature range :	0°F to 120°F (-18°C to +50°C)
Orifice :	1.8 mm
Flow (at 6 bar, ΔP=1bar) :	4 W : 0.09 C _v , 2.5 W : 0.08 C _v , 1.8 W : 0.06 C _v , 1.0 W : 0.05 C _v
Coil :	General purpose class A, continuous duty, encapsulated
Voltage range :	-15% to +10% of nominal voltage
Power :	4 W - 2.5 W - 1.8 W - 1.0 W
Response times :	Energize : 4 ms
(with 4 W coil)	De-energize : 1.5 ms

- Note : • Valve and coil are not interchangeable.
- Spare parts : • Valve mounting kit : N-44001-03. • Blanking plate : M-44003.
- Options : • Isolation of inlet and/or exhaust. • BSPP Threads.

DIMENSIONS

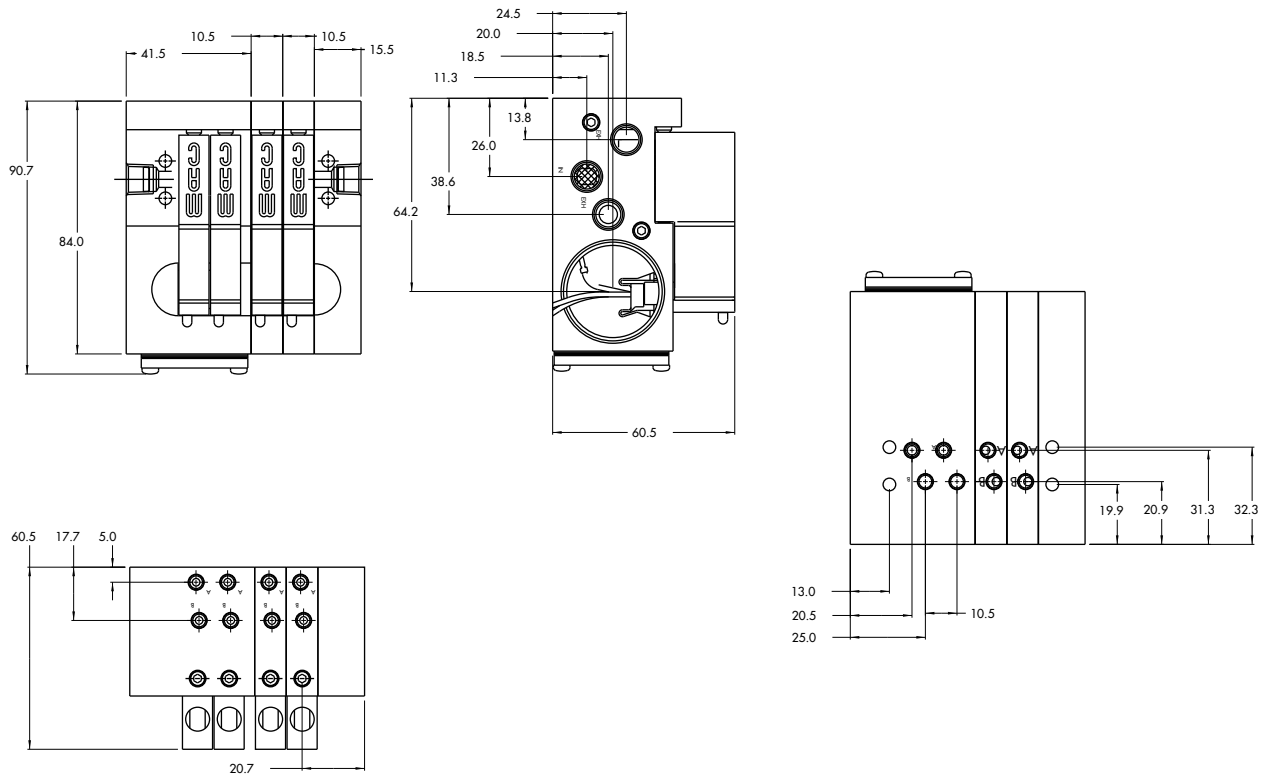

Function	Port size	Flow [Max]	Circuit bar mounting
5/2, 3/2 NO-NC	M5 - #10-32	0.08C_v	add-on style plug-in with F. C.

OPERATIONAL BENEFITS

1. 10 mm valve, direct solenoid operated.
2. Balanced poppet, immune to variations of pressure.
3. Short stroke with high flow.
4. The patented solenoid develops high shifting forces.
5. Powerful return spring.
6. Flow is specifically adjusted on each valve.
7. Manual operator standard on all valves.

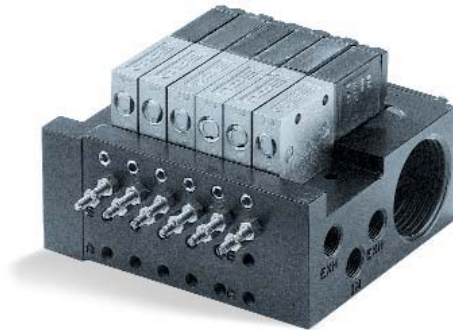

HOW TO ORDER

44B-xxx-GxxO-xxx

HOW TO ORDER VALVE FOR CIRCUIT BAR MOUNTING

Port size (see base)	Single operator
Valve less base	 <input type="radio"/> 44B-MOO-GxxO-xxx

SOLENOID OPERATOR >

G **XX** O- **X** **XX***

XX Voltage	X Manual operator	XX Electrical connection
<input type="radio"/> DA 24VDC (1.0 W)	<input type="radio"/> 1 Non-locking	<input type="radio"/> DJ Plug-in
<input type="radio"/> DC 24VDC (1.8 W)		<input type="radio"/> DT Plug-in with light
<input type="radio"/> DD 24VDC (2.5 W)		<input type="radio"/> DE Plug-in with suppression diode
<input type="radio"/> DF 24VDC (4.0 W)		<input type="radio"/> DV Plug-in with light and suppression diode
<input type="radio"/> xx Other Options		<input type="radio"/> xx Other Options

ECD044B-00xxx-AOxx

HOW TO ORDER CIRCUIT BAR WITH FLOW CONTROLS

Port size	Side cylinder ports (10.5 mm)	Bottom cylinder ports (10.5 mm)
M5	<input type="radio"/> ECD044B-005BD-AOxx	<input type="radio"/> ECD044B-006BD-AOxx
# 10-32	<input type="radio"/> ECD044B-005BB-AOxx	<input type="radio"/> ECD044B-006BB-AOxx

Number of stations (03=3 stations)

Note : clic for valves mounted on base at the factory (add - 9 to the model number).
 clic for multi-pin connector option (9, 15 or 25).
 add-a-unit stations may be added to above bars.

**TECHNICAL
DATA**

Fluid :	Compressed air, vacuum, inert gases
Pressure range :	Vacuum to 120 PSI
Lubrication :	Not required, if used select a medium aniline point lubricant (between 180°F and 210°F)
Filtration :	40 µ
Temperature range :	0°F to 120°F (-18°C to +50°C)
Orifice :	1.8 mm
Flow (at 6 bar, ΔP=1bar) :	4 W : 0.09 C _v , 2.5 W : 0.08 C _v , 1.8 W : 0.06 C _v , 1.0 W : 0.05 C _v
Coil :	General purpose class A, continuous duty, encapsulated
Voltage range :	-15% to +10% of nominal voltage
Power :	4 W - 2.5 W - 1.8 W - 1.0 W
Response times :	Energize : 4 ms
(with 4 W coil)	De-energize : 1.5 ms

- Note :
 - Valve and coil are not interchangeable.
- Spare parts :
 - Valve mounting kit : N-44001-03. • Blanking plate : M-44003. • Flow control needle (x2): N-44002.
 - Base wire Plug-in protector : 24180.
- Options :
 - Isolation of inlet and/or exhaust. • BSPP Threads.

DIMENSIONS

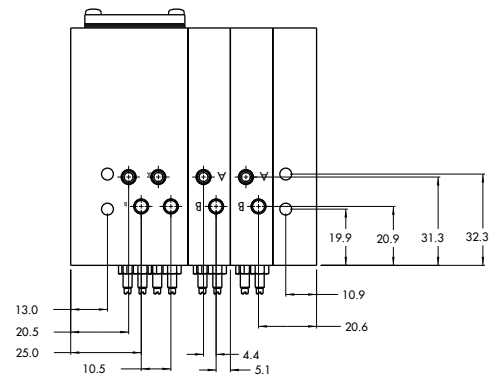
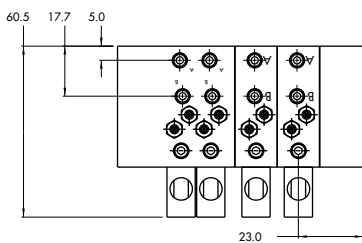
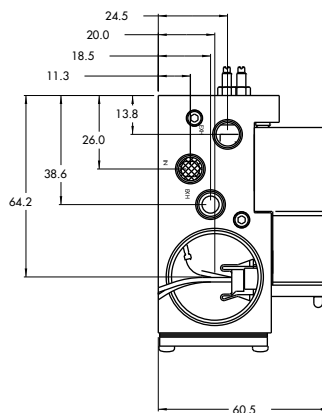
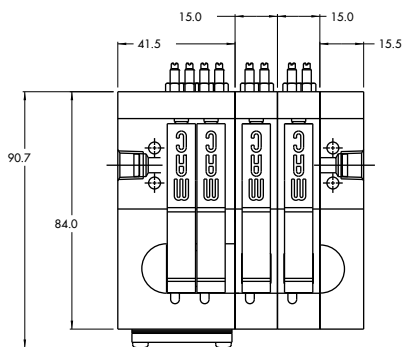

Function	Port size	Flow [Max]	Circuit bar mounting
5/2, 3/2 NO-NC	M5 - #10-32	0.08C_v	add-on style plug-in with Pr. Reg.

OPERATIONAL BENEFITS

1. 10 mm valve, direct solenoid operated.
2. Balanced poppet, immune to variations of pressure.
3. Short stroke with high flow.
4. The patented solenoid develops high shifting forces.
5. Powerful return spring.
6. Flow is specifically adjusted on each valve.
7. Manual operator standard on all valves.



HOW TO ORDER

44B-xxx-GxxO-xxx

HOW TO ORDER VALVE FOR CIRCUIT BAR MOUNTING

Port size (see base)	Single operator
Valve less base	 <input type="radio"/> 44B-LOO-GxxO-xxx

SOLENOID OPERATOR >

G **XX** O- X **XX***

XX Voltage	X Manual operator	XX Electrical connection
<input type="radio"/> DA 24VDC (1.0 W)	<input type="radio"/> 1 Non-locking	<input type="radio"/> DJ Plug-in
<input type="radio"/> DC 24VDC (1.8 W)		<input type="radio"/> DT Plug-in with light
<input type="radio"/> DD 24VDC (2.5 W)		<input type="radio"/> DE Plug-in with suppression diode
<input type="radio"/> DF 24VDC (4.0 W)		<input type="radio"/> DV Plug-in with light and suppression diode
<input type="radio"/> xx Other Options		<input type="radio"/> xx Other Options

ECD044B-00xxx-AOxx

HOW TO ORDER CIRCUIT BAR FOR PRESSURE REGULATORS** (to be ordered separately)

Port size	Bottom cylinder ports (10,5 mm)
M5	<input type="radio"/> ECD044B-004BD-AO-xx
# 10-32	<input type="radio"/> ECD044B-004BB-AO-xx

Number of stations (03=3 stations)
 Note : clic for valves mounted on base at the factory (add - 9 to the model number).
 clic for multi-pin connector option (9, 15 or 25).
 add-a-unit stations may be added to above bars.

- ** Pressure Regulators :
- PR44A-AOxx**
- Y=A (no gage port)
 - Y=B (with gage port)
 - X=A (0 to 100 PSI)
 - X=B (0 to 60 PSI)
 - X=C (0 to 40 PSI)
 - X=D (0 to 15 PSI)

**T E C H N I C A L
D A T A**

Fluid :	Compressed air, vacuum, inert gases
Pressure range :	Vacuum to 120 PSI
Lubrication :	Not required, if used select a medium aniline point lubricant (between 180°F and 210°F)
Filtration :	40 µ
Temperature range :	0°F to 120°F (-18°C to +50°C)
Orifice :	1.8 mm
Flow (at 6 bar, ΔP=1bar) :	4 W : 0.09 C _v , 2.5 W : 0.08 C _v , 1.8 W : 0.06 C _v , 1.0 W : 0.05 C _v
Coil :	General purpose class A, continuous duty, encapsulated
Voltage range :	-15% to +10% of nominal voltage
Power :	4 W - 2.5 W - 1.8 W - 1.0 W
Response times :	Energize : 4 ms
(with 4 W coil)	De-energize : 1.5 ms

- Note :
 - Valve and coil are not interchangeable.
 - Pressure range regulators : (0-100 PSI).
- Spare parts :
 - Valve mounting kit : N-44001-03. • Blanking plate : M-44003. • Blanking plate regulator: N-44003.
 - Base wire Plug-in protector : 24180.
- Options :
 - Isolation of inlet and/or exhaust. • BSPP Threads.

D I M E N S I O N S

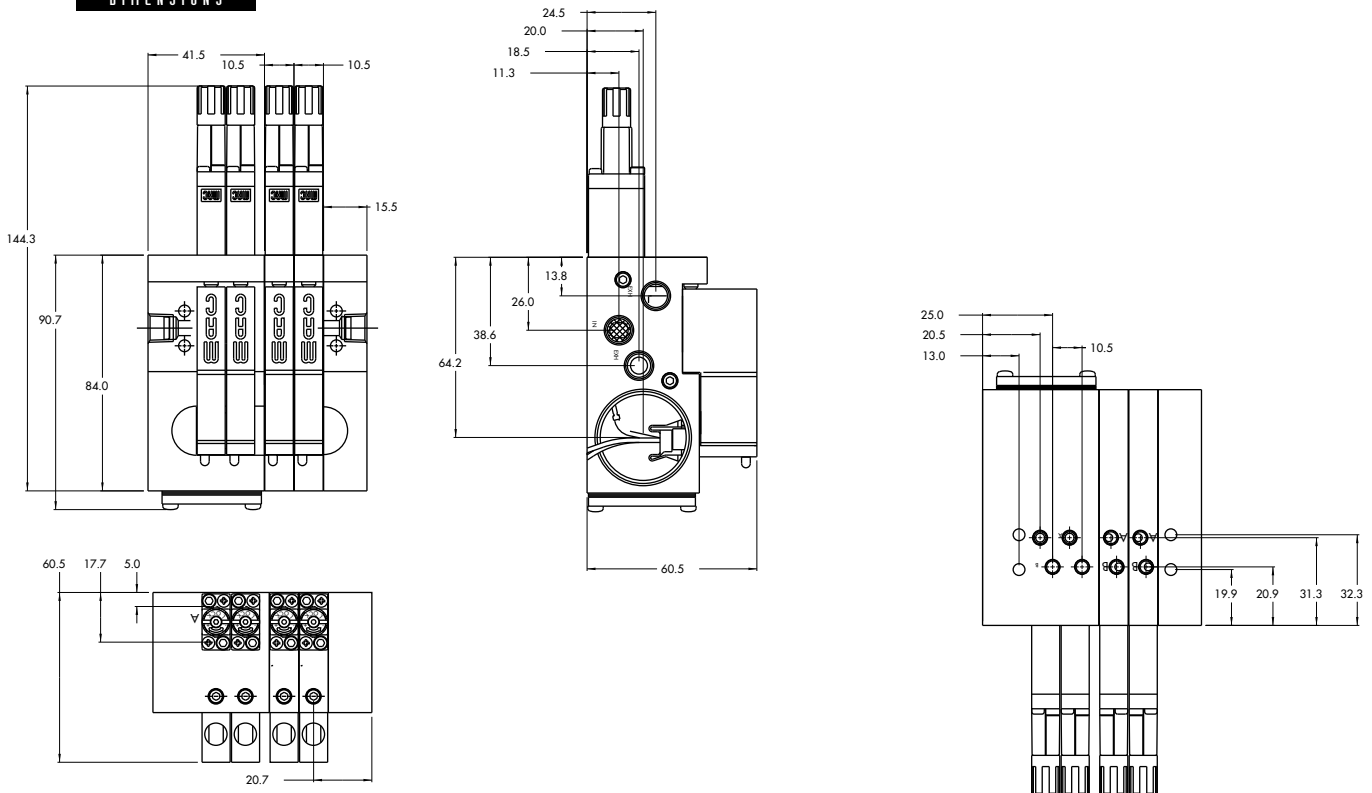

Function	Port size	Flow [Max]	Circuit bar mounting
5/2, 3/2 NO-NC	M5 - #10-32	0.07C_v	add-on style plug-in with Pr. Reg. and F. C.

OPERATIONAL BENEFITS

1. 10 mm valve, direct solenoid operated.
2. Balanced poppet, immune to variations of pressure.
3. Short stroke with high flow.
4. The patented solenoid develops high shifting forces.
5. Powerful return spring.
6. Flow is specifically adjusted on each valve.
7. Manual operator standard on all valves.

Reset

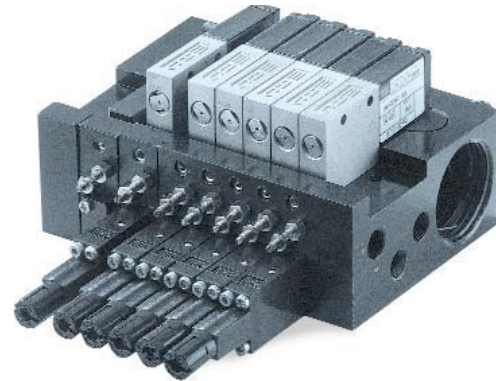

HOW TO ORDER

44B-xxx-GxxO-xxx

HOW TO ORDER VALVE FOR CIRCUIT BAR MOUNTING

Port size (see base)	Single operator
Valve less base	 <input type="radio"/> 44B-MOO-GxxO-xxx

SOLENOID OPERATOR >

G XX O- X XX *		
XX Voltage	X Manual operator	XX Electrical connection
<input type="radio"/> DA 24VDC (1.0 W)	<input type="radio"/> 1 Non-locking	<input type="radio"/> DJ Plug-in
<input type="radio"/> DC 24VDC (1.8 W)		<input type="radio"/> DT Plug-in with light
<input type="radio"/> DD 24VDC (2.5 W)		<input type="radio"/> DE Plug-in with suppression diode
<input type="radio"/> DF 24VDC (4.0 W)		<input type="radio"/> DV Plug-in with light and suppression diode
<input type="radio"/> xx Other Options		<input type="radio"/> xx Other Options

ECD044B-00xxx-AOxx

HOW TO ORDER CIRCUIT BAR WITH FLOW CONTROLS AND PRESSURE REGULATORS** (pressure regulators to be ordered separately)

Port size	Bottom cylinder ports (10,5 mm)
M5	<input type="radio"/> ECD044B-007BD-AO-xx
# 10-32	<input type="radio"/> ECD044B-007BB-AO-xx

Number of stations (03=3 stations)

Note : clic for valves mounted on base at the factory (add - 9 to the model number).
 clic for multi-pin connector option (9, 15 or 25).
 add-a-unit stations may be added to above bars.

** Pressure Regulators :

- PR44A-AOxx**
- Y=A (no gage port)
 - Y=B (with gage port)
 - X=A (0 to 100 PSI)
 - X=B (0 to 60 PSI)
 - X=C (0 to 40 PSI)
 - X=D (0 to 15 PSI)

**TECHNICAL
DATA**

Fluid :	Compressed air, vacuum, inert gases
Pressure range :	Vacuum to 120 PSI
Lubrication :	Not required, if used select a medium aniline point lubricant (between 180°F and 210°F)
Filtration :	40 µ
Temperature range :	0°F to 120°F (-18°C to +50°C)
Orifice :	1.8 mm
Flow (at 6 bar, ΔP=1bar) :	4 W : 0.07 C _v , 2.5 W : 0.06 C _v , 1.8 W : 0.06 C _v , 1.0 W : 0.05 C _v
Coil :	General purpose class A, continuous duty, encapsulated
Voltage range :	-15% to +10% of nominal voltage
Power :	4 W - 2.5 W - 1.8 W - 1.0 W
Response times :	Energize : 4 ms
(with 4 W coil)	De-energize : 1.5 ms

- Note :
- Valve and coil are not interchangeable.
 - Pressure range regulators : (0-100 PSI).
- Spare parts :
- Valve mounting kit : N-44001-03. • Blanking plate : M-44003. • Blanking plate regulator: N-44003.
 - Base wire Plug-in protector : 24180.
- Options :
- Isolation of inlet and/or exhaust. • BSPP Threads.

DIMENSIONS

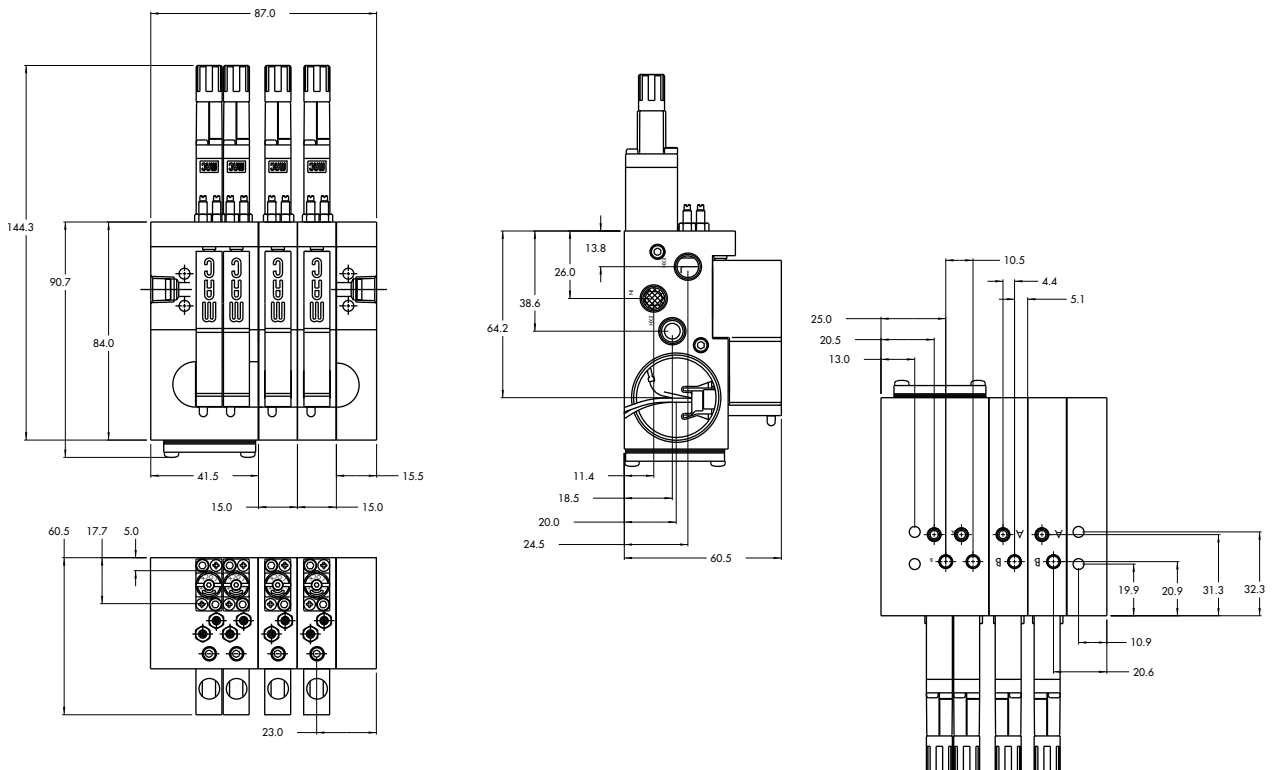



Direct solenoid and solenoid pilot operated valves

Function	Port size	Flow [Max]	Circuit bar mounting
5/2	M5 - #10-32	0.09C_v	plug-in add-a-unit stations

OPERATIONAL BENEFITS

1. 10 mm valve, direct solenoid operated.
2. Balanced poppet, immune to variations of pressure.
3. Short stroke with high flow.
4. The patented solenoid develops high shifting forces.
5. Powerful return spring.
6. Flow is specifically adjusted on each valve.
7. Manual operator standard on all valves.



HOW TO ORDER

44B-xxx-GxxO-xxx

HOW TO ORDER VALVE FOR CIRCUIT BAR MOUNTING

Port size (see base)	Single operator
Valve less base	 <input type="radio"/> 44B-LOO-GxxO-xxx

SOLENOID OPERATOR >

G XX O- X XX*

XX Voltage	X Manual operator	XX Electrical connection
<input type="radio"/> DA 24VDC (1.0 W)	<input type="radio"/> 1 Non-locking	<input type="radio"/> DJ Plug-in
<input type="radio"/> DC 24VDC (1.8 W)		<input type="radio"/> DT Plug-in with light
<input type="radio"/> DD 24VDC (2.5 W)		<input type="radio"/> DE Plug-in with suppression diode
<input type="radio"/> DF 24VDC (4.0 W)		<input type="radio"/> DV Plug-in with light and suppression diode
<input type="radio"/> xx Other Options		<input type="radio"/> xx Other Options

ECD044B-00xxx-AOxx

HOW TO ORDER CIRCUIT BAR

Port size	Side cylinder ports	Bottom cylinder ports
M5	<input type="radio"/> ECD044B-001CD-AOxx	<input type="radio"/> ECD044B-002CD-AOxx
# 10-32	<input type="radio"/> ECD044B-001CB-AOxx	<input type="radio"/> ECD044B-002CB-AOxx

Number of stations (03=3 stations) - Maximum length is 4 stations
 Note: clic for valves mounted on base at the factory (add - 9 to the model number), when add-a-unit stations are added to bars with a multi-pin connector, MOD. SD03 should be included with add-a-unit model number.

**TECHNICAL
DATA**

Fluid :	Compressed air, vacuum, inert gases
Pressure range :	Vacuum to 120 PSI
Lubrication :	Not required, if used select a medium aniline point lubricant (between 180°F and 210°F)
Filtration :	40 µ
Temperature range :	0°F to 120°F (-18°C to +50°C)
Orifice :	1.8 mm
Flow (at 6 bar, ΔP=1bar) :	4 W : 0.09 C _v , 2.5 W : 0.08 C _v , 1.8 W : 0.06 C _v , 1.0 W : 0.05 C _v
Coil :	General purpose class A, continuous duty, encapsulated
Voltage range :	-15% to +10% of nominal voltage
Power :	4 W - 2.5 W - 1.8 W - 1.0 W
Response times :	Energize : 4 ms
(with 4 W coil)	De-energize : 1.5 ms

- Note : • Valve and coil are not interchangeable.
- Spare parts : • Valve mounting kit : N-44001-03. • Blanking plate : M-44003.
- Options : • Isolation of inlet and/or exhaust. • BSPP Threads.

DIMENSIONS

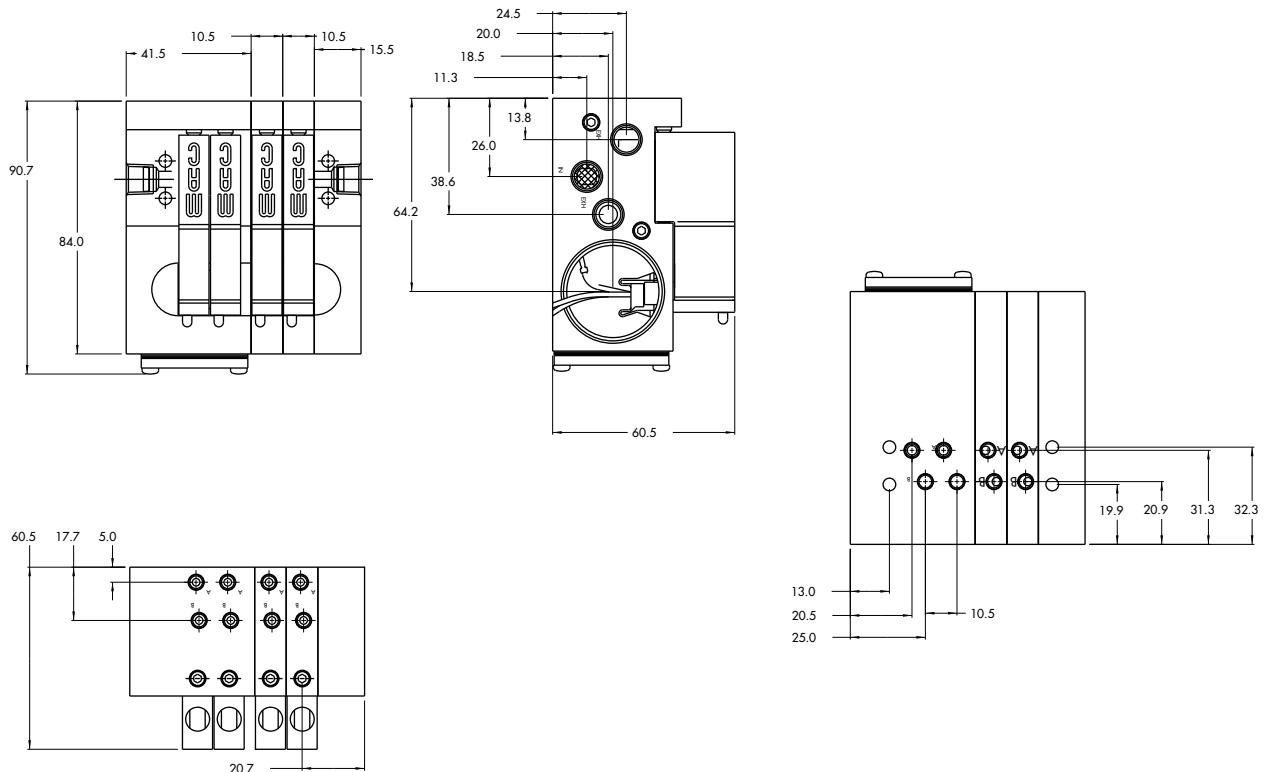

Function	Port size	Flow [Max]	Circuit bar mounting
5/2	M5 - #10-32	0.08C_v	plug-in add-a-unit stations with F. C.

OPERATIONAL BENEFITS

1. 10 mm valve, direct solenoid operated.
2. Balanced poppet, immune to variations of pressure.
3. Short stroke with high flow.
4. The patented solenoid develops high shifting forces.
5. Powerful return spring.
6. Flow is specifically adjusted on each valve.
7. Manual operator standard on all valves.



HOW TO ORDER

44B-xxx-GxxO-xxx

HOW TO ORDER VALVE FOR CIRCUIT BAR MOUNTING

Port size (see base)	Single operator
Valve less base	 <input type="radio"/> 44B-MOO-GxxO-xxx

SOLENOID OPERATOR >

G **XX** O- **X** **XX**

XX Voltage	X Manual operator	XX Electrical connection
<input type="radio"/> DA 24VDC (1.0 W)	<input type="radio"/> 1 Non-locking	<input type="radio"/> DJ Plug-in
<input type="radio"/> DC 24VDC (1.8 W)		<input type="radio"/> DT Plug-in with light
<input type="radio"/> DD 24VDC (2.5 W)		<input type="radio"/> DE Plug-in with suppression diode
<input type="radio"/> DF 24VDC (4.0 W)		<input type="radio"/> DV Plug-in with light and suppression diode
<input type="radio"/> xx Other Options		<input type="radio"/> xx Other Options

ECD044B-00xxx-AOxx

HOW TO ORDER CIRCUIT BAR WITH FLOW CONTROLS

Port size	Side cylinder ports	Bottom cylinder ports
M5	<input type="radio"/> ECD044B-005CD-AOxx	<input type="radio"/> ECD044B-006CD-AOxx
# 10-32	<input type="radio"/> ECD044B-005CB-AOxx	<input type="radio"/> ECD044B-006CB-AOxx

Number of stations (03=3 stations) - Maximum length is 4 stations
 Note : clic for valves mounted on base at the factory (add - 9 to the model number).
 when add-a-unit stations are added to bars with a multi-pin connector,
 MOD. SD03 should be included with add-a-unit model number.

**TECHNICAL
DATA**

Fluid :	Compressed air, vacuum, inert gases
Pressure range :	Vacuum to 120 PSI
Lubrication :	Not required, if used select a medium aniline point lubricant (between 180°F and 210°F)
Filtration :	40 µ
Temperature range :	0°F to 120°F (-18°C to +50°C)
Orifice :	1.8 mm
Flow (at 6 bar, ΔP=1bar) :	4 W : 0.09 C _v , 2.5 W : 0.08 C _v , 1.8 W : 0.06 C _v , 1.0 W : 0.05 C _v
Coil :	General purpose class A, continuous duty, encapsulated
Voltage range :	-15% to +10% of nominal voltage
Power :	4 W - 2.5 W - 1.8 W - 1.0 W
Response times :	Energize : 4 ms
(with 4 W coil)	De-energize : 1.5 ms

- Note :
- Valve and coil are not interchangeable.
- Spare parts :
- Valve mounting kit : N-44001-03. • Blanking plate : M-44003. • Flow control needle (x2): N-44002.
 - Base wire Plug-in protector : 24180.
- Options :
- Isolation of inlet and/or exhaust. • BSPP Threads.

DIMENSIONS

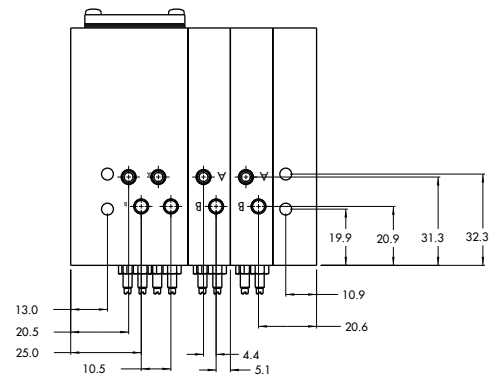
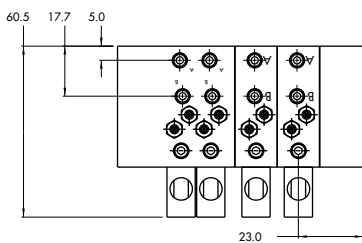
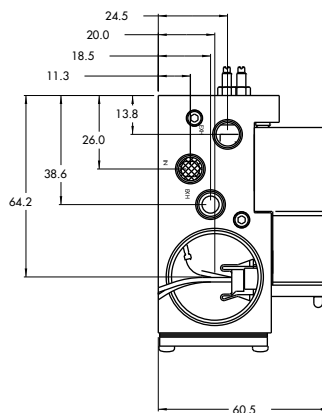
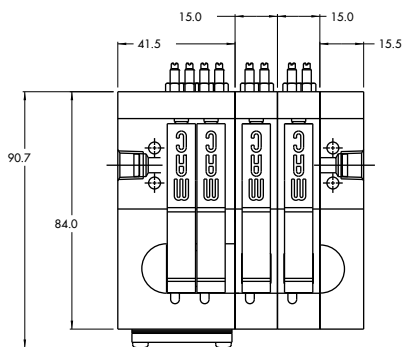

Function	Port size	Flow [Max]	Circuit bar mounting
5/2	M5 - #10-32	0.08C_v	plug-in add-a-unit stations with Pr. Reg.

OPERATIONAL BENEFITS

1. 10 mm valve, direct solenoid operated.
2. Balanced poppet, immune to variations of pressure.
3. Short stroke with high flow.
4. The patented solenoid develops high shifting forces.
5. Powerful return spring.
6. Flow is specifically adjusted on each valve.
7. Manual operator standard on all valves.

Reset

HOW TO ORDER

44B-xxx-GxxO-xxx

HOW TO ORDER VALVE FOR CIRCUIT BAR MOUNTING

Port size (see base)	Single operator
Valve less base	 <input type="radio"/> 44B-LOO-GxxO-xxx

SOLENOID OPERATOR >

G XX O- X XX*

XX Voltage	X Manual operator	XX Electrical connection
<input type="radio"/> DA 24VDC (1.0 W)	<input type="radio"/> 1 Non-locking	<input type="radio"/> DJ Plug-in
<input type="radio"/> DC 24VDC (1.8 W)		<input type="radio"/> DT Plug-in with light
<input type="radio"/> DD 24VDC (2.5 W)		<input type="radio"/> DE Plug-in with suppression diode
<input type="radio"/> DF 24VDC (4.0 W)		<input type="radio"/> DV Plug-in with light and suppression diode
<input type="radio"/> xx Other Options		<input type="radio"/> xx Other Options

ECD044B-00xxx-AOxx

HOW TO ORDER CIRCUIT BAR FOR PRESSURE REGULATORS ** (to be ordered separately)

Port size	Bottom cylinder ports (10,5 mm)
M5	<input type="radio"/> ECD044B-004CD-AOxx
# 10-32	<input type="radio"/> ECD044B-004CB-AOxx

Number of stations (03=3 stations) - Maximum length is 4 stations
 Note: clic for valves mounted on base at the factory (add - 9 to the model number).
 when add-a-unit stations are added to bars with a multi-pin connector,
 MOD. SD03 should be included with add-a-unit model number.

** Regulator ordered separately-see below :

- PR44A-AOxx**
- Y=A (no gage port)
 - Y=B (with gage port)
 - X=A (0 to 100 PSI)
 - X=B (0 to 60 PSI)
 - X=C (0 to 40 PSI)
 - X=D (0 to 15 PSI)

**TECHNICAL
DATA**

Fluid :	Compressed air, vacuum, inert gases
Pressure range :	Vacuum to 120 PSI
Lubrication :	Not required, if used select a medium aniline point lubricant (between 180°F and 210°F)
Filtration :	40 µ
Temperature range :	0°F to 120°F (-18°C to +50°C)
Orifice :	1.8 mm
Flow (at 6 bar, ΔP=1bar) :	4 W : 0.09 C _v , 2.5 W : 0.08 C _v , 1.8 W : 0.06 C _v , 1.0 W : 0.05 C _v
Coil :	General purpose class A, continuous duty, encapsulated
Voltage range :	-15% to +10% of nominal voltage
Power :	4 W - 2.5 W - 1.8 W - 1.0 W
Response times :	Energize : 4 ms
(with 4 W coil)	De-energize : 1.5 ms

- Note :
- Valve and coil are not interchangeable.
 - Pressure range regulators : (0-100 PSI).
- Spare parts :
- Valve mounting kit : N-44001-03. • Blanking plate : M-44003. • Blanking plate regulator: N-44003.
 - Base wire Plug-in protector : 24180.
- Options :
- Isolation of inlet and/or exhaust. • BSPP Threads.

DIMENSIONS

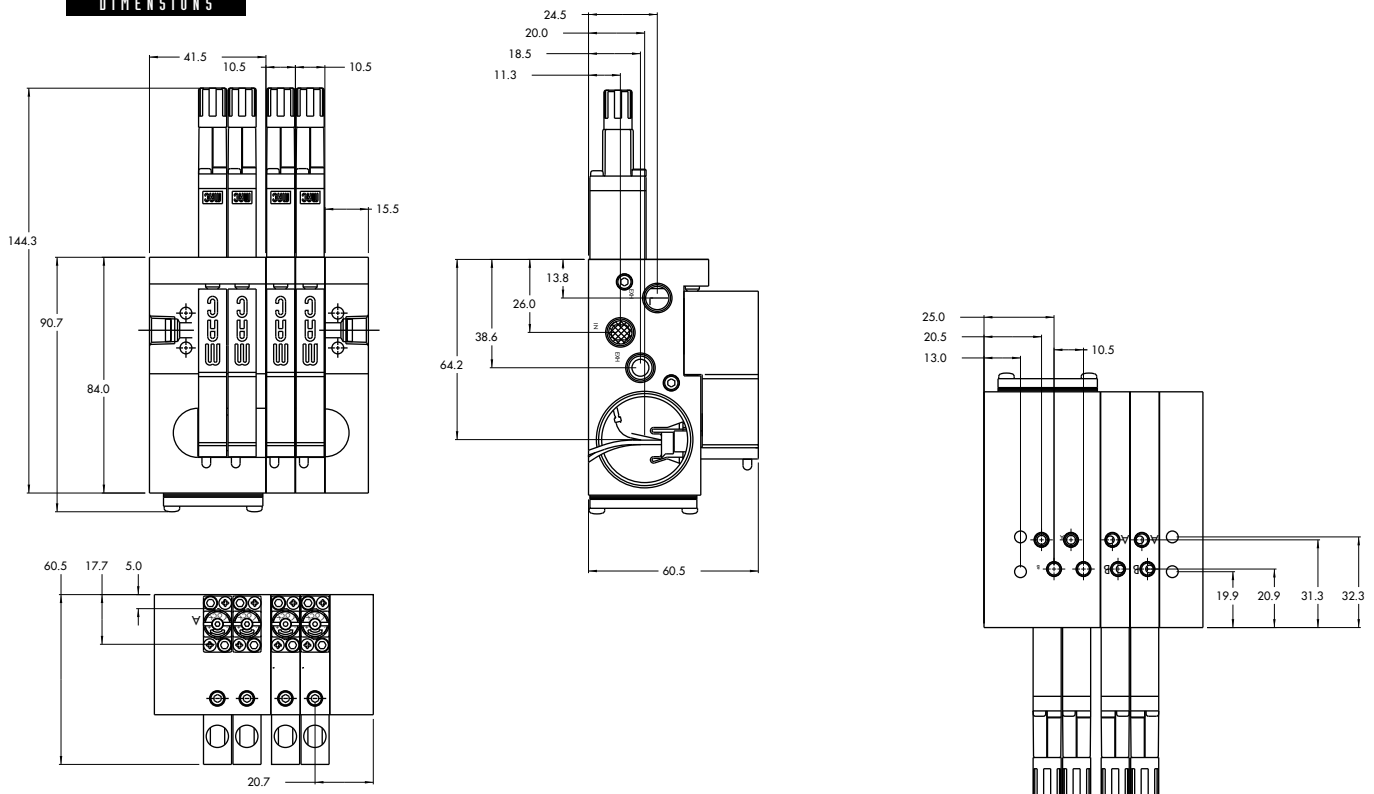

Function	Port size	Flow [Max]	Circuit bar mounting
5/2	M5 - #10-32	0.07C_v	plug-in add-a-unit stations with F. C. and Pr. Reg.

OPERATIONAL BENEFITS

1. 10 mm valve, direct solenoid operated.
2. Balanced poppet, immune to variations of pressure.
3. Short stroke with high flow.
4. The patented solenoid develops high shifting forces.
5. Powerful return spring.
6. Flow is specifically adjusted on each valve.
7. Manual operator standard on all valves.

Reset

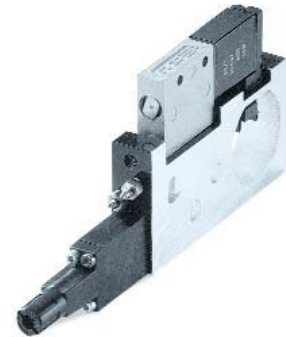

HOW TO ORDER

44B-xxx-GxxO-xxx

HOW TO ORDER VALVE FOR CIRCUIT BAR MOUNTING

Port size (see base)	Single operator
Valve less base	 <input type="radio"/> 44B-MOO-GxxO-xxx

SOLENOID OPERATOR >

XX Voltage		X Manual operator	XX Electrical connection
<input type="radio"/> DA	24VDC (1.0 W)	<input type="radio"/> 1 Non-locking	<input type="radio"/> DJ Plug-in
<input type="radio"/> DC	24VDC (1.8 W)		<input type="radio"/> DT Plug-in with light
<input type="radio"/> DD	24VDC (2.5 W)		<input type="radio"/> DE Plug-in with suppression diode
<input type="radio"/> DF	24VDC (4.0 W)		<input type="radio"/> DV Plug-in with light and suppression diode
<input type="radio"/> xx	Other Options		<input type="radio"/> xx Other Options

ECD044B-00xxx-AOxx

HOW TO ORDER CIRCUIT BAR WITH FLOW CONTROLS AND PRESSURE REGULATORS ** (pressure regulators to be ordered separately)

Port size	Bottom cylinder ports (10,5 mm)
M5	<input type="radio"/> ECD044B-007CD-AOxx
# 10-32	<input type="radio"/> ECD044B-007CB-AOxx

Number of stations (03=3 stations) - Maximum length is 4 stations
 Note : clic for valves mounted on base at the factory (add - 9 to the model number).
 when add-a-unit stations are added to bars with a multi-pin connector, MOD. SD03 should be included with add-a-unit model number.

** Regulator ordered separately-see below :

- PR44A-AOxx**
- Y=A (no gage port)
 - Y=B (with gage port)
 - X=A (0 to 100 PSI)
 - X=B (0 to 60 PSI)
 - X=C (0 to 40 PSI)
 - X=D (0 to 15 PSI)

**TECHNICAL
DATA**

Fluid :	Compressed air, vacuum, inert gases
Pressure range :	Vacuum to 120 PSI
Lubrication :	Not required, if used select a medium aniline point lubricant (between 180°F and 210°F)
Filtration :	40 µ
Temperature range :	0°F to 120°F (-18°C to +50°C)
Orifice :	1.8 mm
Flow (at 6 bar, ΔP=1bar) :	4 W : 0.07 C _v , 2.5 W : 0.06 C _v , 1.8 W : 0.06 C _v , 1.0 W : 0.05 C _v
Coil :	General purpose class A, continuous duty, encapsulated
Voltage range :	-15% to +10% of nominal voltage
Power :	4 W - 2.5 W - 1.8 W - 1.0 W
Response times :	Energize : 4 ms
(with 4 W coil)	De-energize : 1.5 ms

- Note :
- Valve and coil are not interchangeable.
 - Pressure range regulators : (0-100 PSI).
- Spare parts :
- Valve mounting kit : N-44001-03. • Blanking plate : M-44003. • Blanking plate regulator: N-44003.
 - Base wire Plug-in protector : 24180.
- Options :
- Isolation of inlet and/or exhaust. • BSPP Threads.

DIMENSIONS

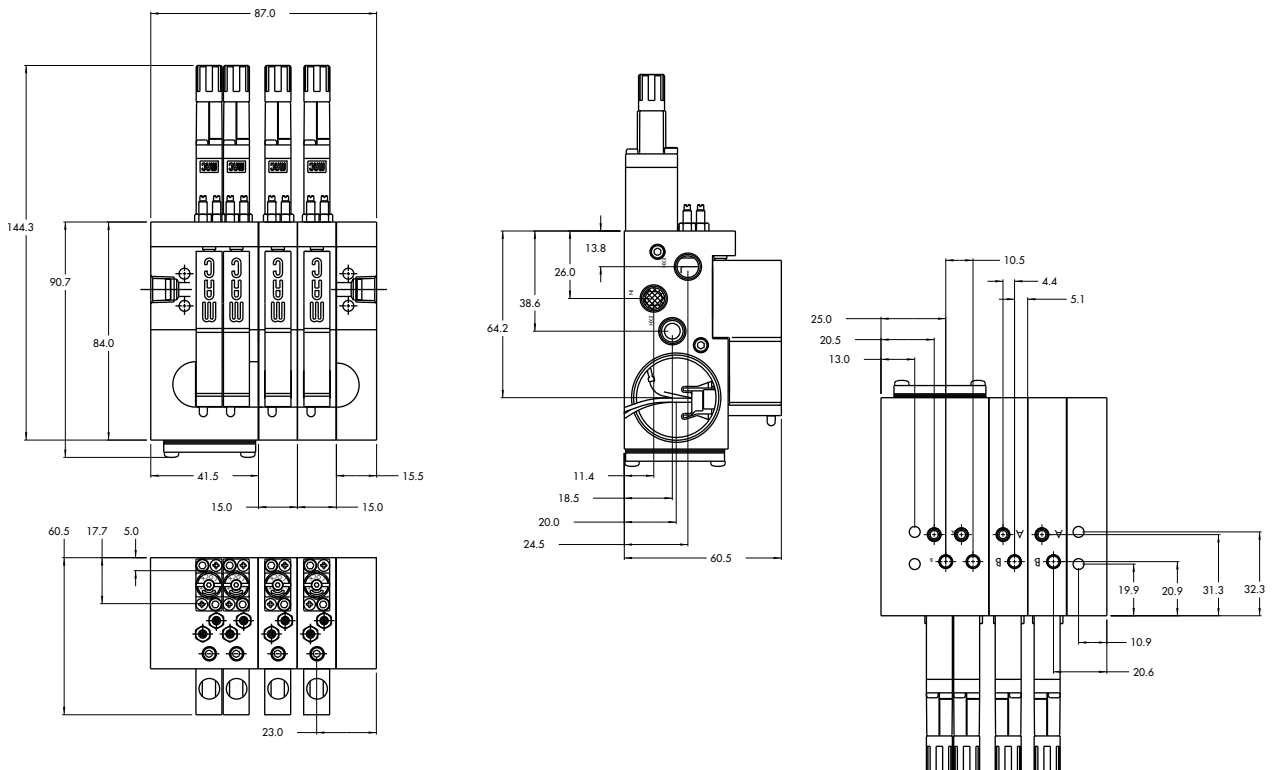

Function	Port size	Flow [Max]	Circuit bar mounting
5/2, 3/2 NO-NC	M5 - #10-32, 4 mm tube receptacle	0.10C_v	plug-in with pre-wired connector

OPERATIONAL BENEFITS

1. 10 mm valve, direct solenoid operated.
2. Balanced poppet, immune to variations of pressure.
3. Short stroke with high flow.
4. The patented solenoid develops high shifting forces.
5. Powerful return spring.
6. Flow is specifically adjusted on each valve.
7. Manual operator standard on all valves.

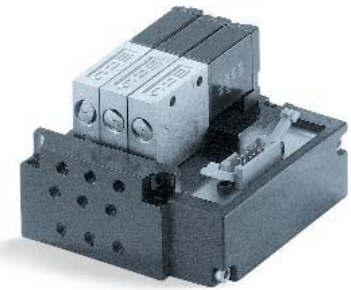

HOW TO ORDER

44B-xxx-GxxO-xxx

HOW TO ORDER VALVE FOR CIRCUIT BAR MOUNTING

Port size (see base)	Single operator
Valve less base	 <input type="radio"/> 44B-LOO-GxxO-xxx

SOLENOID OPERATOR >

G XX O - X XX *

XX Voltage	X Manual operator	XX Electrical connection
<input type="radio"/> DA 24VDC (1.0 W)	<input type="radio"/> 1 Non-locking	<input type="radio"/> DJ Plug-in
<input type="radio"/> DC 24VDC (1.8 W)		<input type="radio"/> DT Plug-in with light
<input type="radio"/> DD 24VDC (2.5 W)		<input type="radio"/> DE Plug-in with suppression diode
<input type="radio"/> DF 24VDC (4.0 W)		<input type="radio"/> DV Plug-in with light and suppression diode
<input type="radio"/> xx Other Options		<input type="radio"/> xx Other Options

ECF44B-00xxx-xxxx

HOW TO ORDER CIRCUIT BAR **

Port size	Side cylinder ports (10.5 mm)	Bottom cylinder ports (10.5 mm)
M5	<input type="radio"/> ECF44B-00BDA-zzxx	<input type="radio"/> ECF44B-00CDA-zzxx
# 10-32	<input type="radio"/> ECF44B-00BBA-zzxx	<input type="radio"/> ECF44B-00CBA-zzxx
4 mm tube receptacle	<input type="radio"/> ECF44B-00BEA-zzxx

Number of stations (03=3 stations)

** Other options available Consult factory.

Note: clic for valves mounted on base at the factory (add - 9 to the model number).

L=Left Side; R=Right Side

ZZ Connector	ZZ Connector
<input type="radio"/> LA 9 Pin Sub D*	<input type="radio"/> RA 9 Pin Sub D*
<input type="radio"/> LB 15 Pin Sub D*	<input type="radio"/> RB 15 Pin Sub D*
<input type="radio"/> LC 25 Pin Sub D*	<input type="radio"/> RC 25 Pin Sub D*
<input type="radio"/> LD 10 Pin Ribbon Cable**	<input type="radio"/> RD 10 Pin Ribbon Cable**
<input type="radio"/> LE 16 Pin Ribbon Cable**	<input type="radio"/> RE 16 Pin Ribbon Cable**
<input type="radio"/> LF 20 Pin Ribbon Cable**	<input type="radio"/> RF 20 Pin Ribbon Cable**
<input type="radio"/> LG 26 Pin Ribbon Cable**	<input type="radio"/> RG 26 Pin Ribbon Cable**
<input type="radio"/> LH 3/8" NPSM Conduit Port Standard Base Wires	<input type="radio"/> RH 3/8" NPSM Conduit Port Standard Base Wires

* MIL. Spec; MIL-C-24308

** MIL. Spec; MIL-C-83503

Note: Left and right end is determined by facing conduit passage.

**TECHNICAL
DATA**

Fluid :	Compressed air, vacuum, inert gases
Pressure range :	Vacuum to 120 PSI
Lubrication :	Not required, if used select a medium aniline point lubricant (between 180°F and 210°F)
Filtration :	40 µ
Temperature range :	0°F to 120°F (-18°C to +50°C)
Orifice :	1.8 mm
Flow (at 6 bar, ΔP=1bar) :	4 W : 0.10 C _v , 2.5 W : 0.08 C _v , 1.8 W : 0.06 C _v , 1.0 W : 0.05 C _v
Coil :	General purpose class A, continuous duty, encapsulated
Voltage range :	-15% to +10% of nominal voltage
Power :	4 W - 2.5 W - 1.8 W - 1.0 W
Response times :	Energize : 4 ms
(with 4 W coil)	De-energize : 1.5 ms

- Note : • Valve and coil are not interchangeable.
- Spare parts : • Valve mounting kit : N-44001-03. • Blanking plate : M-44003. • Base wire Plug-in protector : 24180.
- Options : • Isolation of inlet and/or exhaust. • BSPP threads.

DIMENSIONS

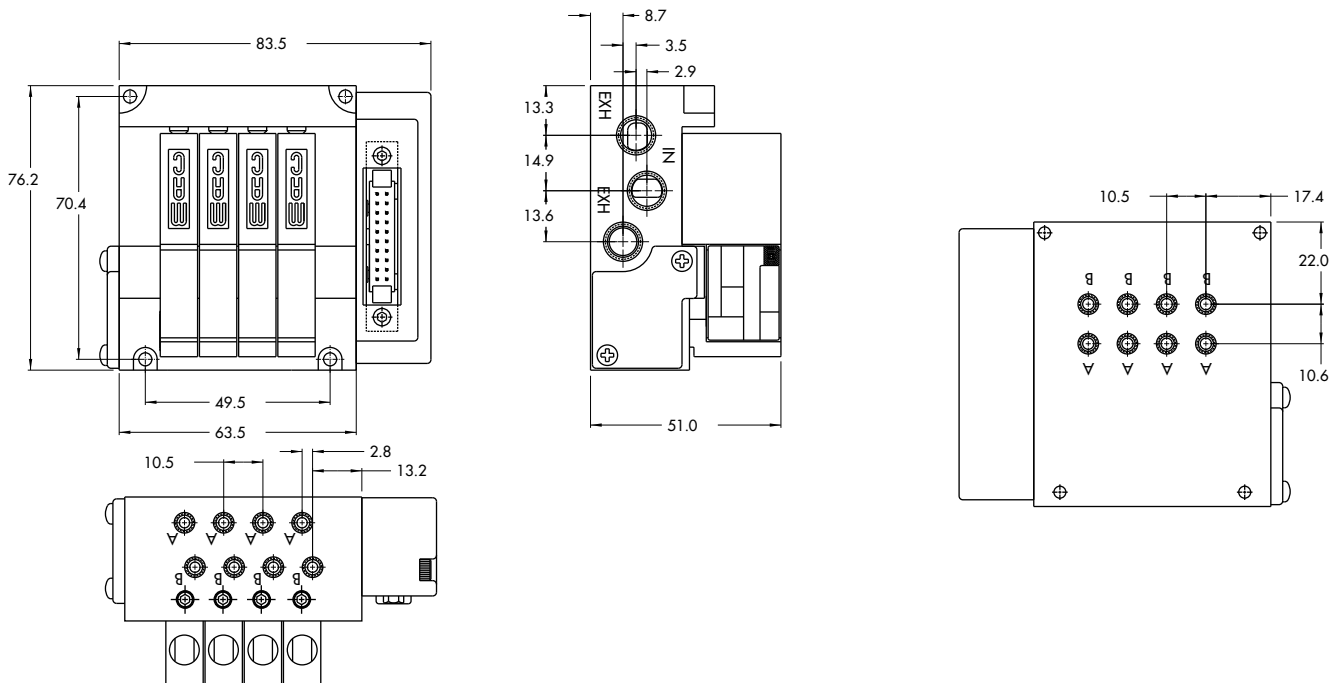



Direct solenoid and solenoid pilot operated valves

Function	Port size	Flow [Max]	Circuit bar mounting
5/2, 3/2 NO-NC	M5 - #10-32	0.09C_v	plug-in with F. C. and pre-wired connector

OPERATIONAL BENEFITS

1. 10 mm valve, direct solenoid operated.
2. Balanced poppet, immune to variations of pressure.
3. Short stroke with high flow.
4. The patented solenoid develops high shifting forces.
5. Powerful return spring.
6. Flow is specifically adjusted on each valve.
7. Manual operator standard on all valves.



HOW TO ORDER

44B-xxx-GxxO-xxx

HOW TO ORDER VALVE FOR CIRCUIT BAR MOUNTING

Port size (see base)	Single operator
Valve less base	 <input type="radio"/> 44B-MOO-GxxO-xxx

SOLENOID OPERATOR ▶

G XX O - X XX *

XX Voltage	X Manual operator	XX Electrical connection
<input type="radio"/> DA 24VDC (1.0 W)	<input type="radio"/> 1 Non-locking	<input type="radio"/> DJ Plug-in
<input type="radio"/> DC 24VDC (1.8 W)		<input type="radio"/> DT Plug-in with light
<input type="radio"/> DD 24VDC (2.5 W)		<input type="radio"/> DE Plug-in with suppression diode
<input type="radio"/> DF 24VDC (4.0 W)		<input type="radio"/> DV Plug-in with light and suppression diode
<input type="radio"/> xx Other Options		<input type="radio"/> xx Other Options

HOW TO ORDER CIRCUIT BAR WITH FLOW CONTROLS **

ECF44B-00xxx-xxxx

Port size	Bottom cylinder ports (10.5 mm)
M5 # 10-32	<input type="radio"/> ECF44B-00EDA-zzxx <input type="radio"/> ECF44B-00EBA-zzxx

Number of stations (03=3 stations)

** Other options available Consult factory.

Note: clic for valves mounted on base at the factory (add - 9 to the model number).

L=Left Side; R=Right Side			
ZZ	Connector	ZZ	Connector
<input type="radio"/> LA	9 Pin Sub D*	<input type="radio"/> RA	9 Pin Sub D*
<input type="radio"/> LB	15 Pin Sub D*	<input type="radio"/> RB	15 Pin Sub D*
<input type="radio"/> LC	25 Pin Sub D*	<input type="radio"/> RC	25 Pin Sub D*
<input type="radio"/> LD	10 Pin Ribbon Cable**	<input type="radio"/> RD	10 Pin Ribbon Cable**
<input type="radio"/> LE	16 Pin Ribbon Cable**	<input type="radio"/> RE	16 Pin Ribbon Cable**
<input type="radio"/> LF	20 Pin Ribbon Cable**	<input type="radio"/> RF	20 Pin Ribbon Cable**
<input type="radio"/> LG	26 Pin Ribbon Cable**	<input type="radio"/> RG	26 Pin Ribbon Cable**
<input type="radio"/> LH	3/8" NPSM Conduit Port Standard Base Wires	<input type="radio"/> RH	3/8" NPSM Conduit Port Standard Base Wires

* MIL. Spec; MIL-C-24308

** MIL. Spec; MIL-C-83503

Note: Left and right end is determined by facing conduit passage.

**TECHNICAL
DATA**

Fluid :	Compressed air, vacuum, inert gases
Pressure range :	Vacuum to 120 PSI
Lubrication :	Not required, if used select a medium aniline point lubricant (between 180°F and 210°F)
Filtration :	40 µ
Temperature range :	0°F to 120°F (-18°C to +50°C)
Orifice :	1.8 mm
Flow (at 6 bar, ΔP=1bar) :	4 W : 0.09 C _v , 2.5 W : 0.08 C _v , 1.8 W : 0.06 C _v , 1.0 W : 0.05 C _v
Coil :	General purpose class A, continuous duty, encapsulated
Voltage range :	-15% to +10% of nominal voltage
Power :	4 W - 2.5 W - 1.8 W - 1.0 W
Response times :	Energize : 4 ms
(with 4 W coil)	De-energize : 1.5 ms

- Note :
 - Valve and coil are not interchangeable.
- Spare parts :
 - Valve mounting kit : N-44001-03. • Blanking plate : M-44003. • Flow control needle (x2) : N-44002. • Base wire Plug-in protector : 24180.
- Options :
 - Isolation of inlet and/or exhaust. • BSPP threads.

DIMENSIONS

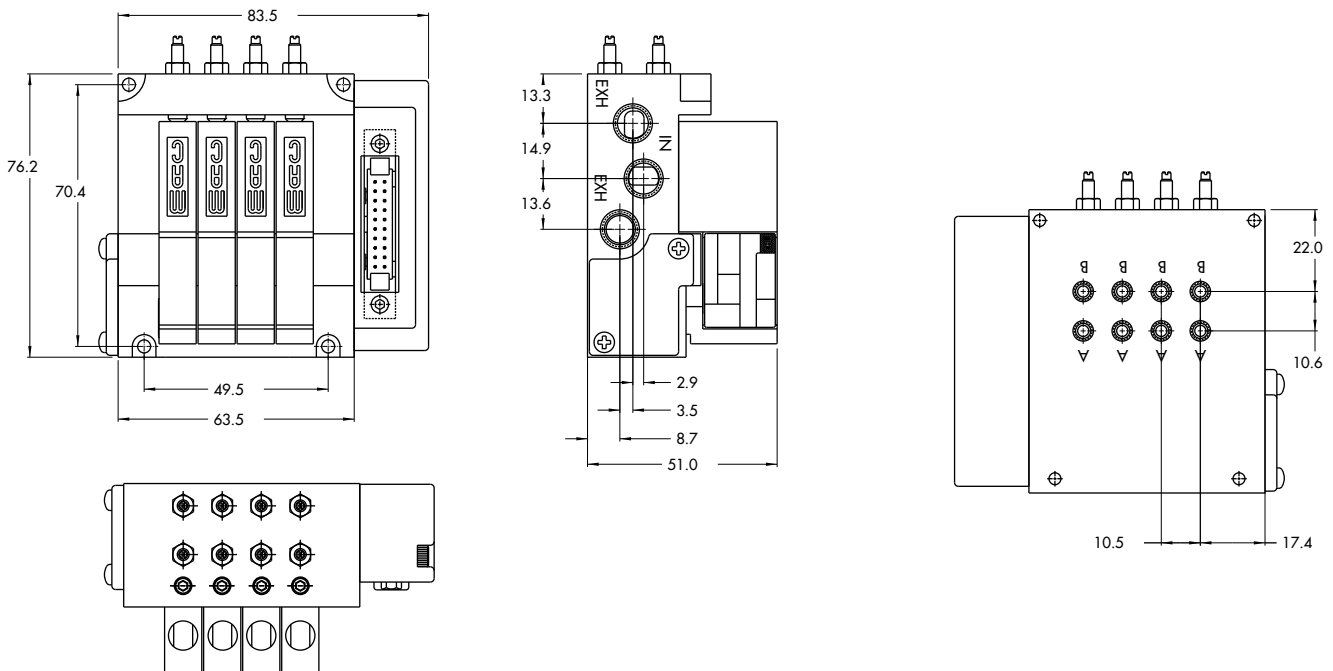

Function	Port size	Flow [Max]	Circuit bar mounting
5/2, 3/2 NO-NC	M5 - #10-32	0.09C_v	plug-in with Pr. Reg. and pre-wired connector

OPERATIONAL BENEFITS

1. 10 mm valve, direct solenoid operated.
2. Balanced poppet, immune to variations of pressure.
3. Short stroke with high flow.
4. The patented solenoid develops high shifting forces.
5. Powerful return spring.
6. Flow is specifically adjusted on each valve.
7. Manual operator standard on all valves.

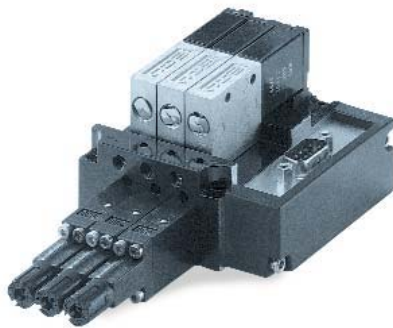

HOW TO ORDER

44B-xxx-GxxO-xxx

HOW TO ORDER VALVE FOR CIRCUIT BAR MOUNTING

Port size (see base)	Single operator
Valve less base	 <input type="radio"/> 44B-LOO-GxxO-xxx

SOLENOID OPERATOR

G XX O - X XX

XX Voltage	X Manual operator	XX Electrical connection
<input type="radio"/> DA 24VDC (1.0 W)	<input type="radio"/> 1 Non-locking	<input type="radio"/> DJ Plug-in
<input type="radio"/> DC 24VDC (1.8 W)		<input type="radio"/> DT Plug-in with light
<input type="radio"/> DD 24VDC (2.5 W)		<input type="radio"/> DE Plug-in with suppression diode
<input type="radio"/> DF 24VDC (4.0 W)		<input type="radio"/> DV Plug-in with light and suppression diode
<input type="radio"/> xx Other Options		<input type="radio"/> xx Other Options

ECF44B-00xxx-xxxx

HOW TO ORDER CIRCUIT BAR FOR PRESSURE REGULATORS ** (to be ordered separately)

Port size	Bottom cylinder ports (10.5 mm)
M5 # 10-32	<input type="radio"/> ECF44B-00GDA-zzxx <input type="radio"/> ECF44B-00GBA-zzxx

Number of stations (03=3 stations)

** Other options available Consult factory.

Note: clic for valves mounted on base at the factory (add - 9 to the model number).

** Pressure Regulators :

- PR44A-AOxx**
- Y=A (no gage port)
 - Y=B (with gage port)
 - X=A (0 to 100 PSI)
 - X=B (0 to 60 PSI)
 - X=C (0 to 40 PSI)
 - X=D (0 to 15 PSI)

L=Left Side; R=Right Side

ZZ	Connector	ZZ	Connector
<input type="radio"/> LA	9 Pin Sub D*	<input type="radio"/> RA	9 Pin Sub D*
<input type="radio"/> LB	15 Pin Sub D*	<input type="radio"/> RB	15 Pin Sub D*
<input type="radio"/> LC	25 Pin Sub D*	<input type="radio"/> RC	25 Pin Sub D*
<input type="radio"/> LD	10 Pin Ribbon Cable**	<input type="radio"/> RD	10 Pin Ribbon Cable**
<input type="radio"/> LE	16 Pin Ribbon Cable**	<input type="radio"/> RE	16 Pin Ribbon Cable**
<input type="radio"/> LF	20 Pin Ribbon Cable**	<input type="radio"/> RF	20 Pin Ribbon Cable**
<input type="radio"/> LG	26 Pin Ribbon Cable**	<input type="radio"/> RG	26 Pin Ribbon Cable**
<input type="radio"/> LH	3/8" NPSM Conduit Port Standard Base Wires	<input type="radio"/> RH	3/8" NPSM Conduit Port Standard Base Wires

* MIL. Spec; MIL-C-24308

** MIL. Spec; MIL-C-83503

Note: Left and right end is determined by facing conduit passage.

**TECHNICAL
DATA**

Fluid :	Compressed air, vacuum, inert gases
Pressure range :	Vacuum to 120 PSI
Lubrication :	Not required, if used select a medium aniline point lubricant (between 180°F and 210°F)
Filtration :	40 µ
Temperature range :	0°F to 120°F (-18°C to +50°C)
Orifice :	1.8 mm
Flow (at 6 bar, ΔP=1bar) :	4 W : 0.09 C _v , 2.5 W : 0.08 C _v , 1.8 W : 0.06 C _v , 1.0 W : 0.05 C _v
Coil :	General purpose class A, continuous duty, encapsulated
Voltage range :	-15% to +10% of nominal voltage
Power :	4 W - 2.5 W - 1.8 W - 1.0 W
Response times :	Energize : 4 ms
(with 4 W coil)	De-energize : 1.5 ms

- Note :
- Valve and coil are not interchangeable.
 - Pressure range regulator (0-100 PSI)
- Spare parts :
- Valve mounting kit : N-44001-03. • Blanking plate : M-44003. • Blanking plate regulator : N-44003.
 - Base wire Plug-in protector : 24180.
- Options :
- Isolation of inlet and/or exhaust. • BSPP threads.

DIMENSIONS

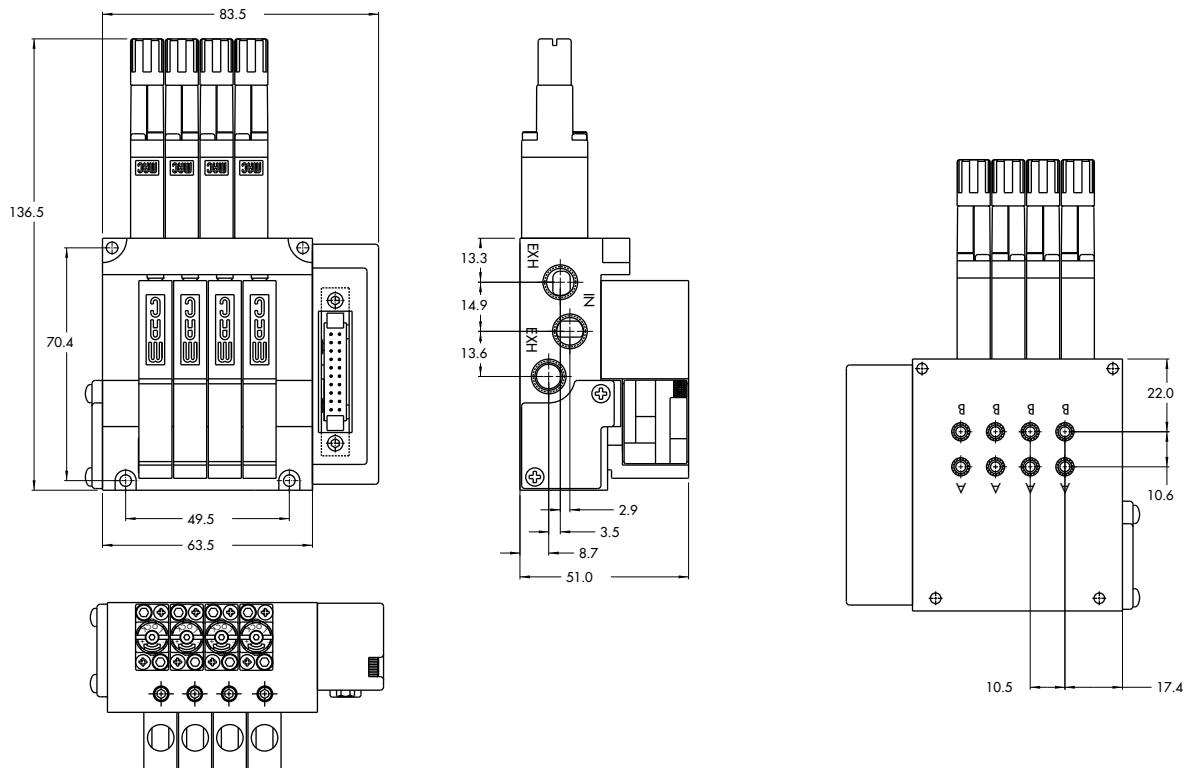

Function	Port size	Flow [Max]	Circuit bar mounting
5/2, 3/2 NO-NC	M5 - #10-32, 4 mm tube receptacle	0.10C_v	din rail, plug-in with pre-wired connector

OPERATIONAL BENEFITS

1. 10 mm valve, direct solenoid operated.
2. Balanced poppet, immune to variations of pressure.
3. Short stroke with high flow.
4. The patented solenoid develops high shifting forces.
5. Powerful return spring.
6. Flow is specifically adjusted on each valve.
7. Manual operator standard on all valves.

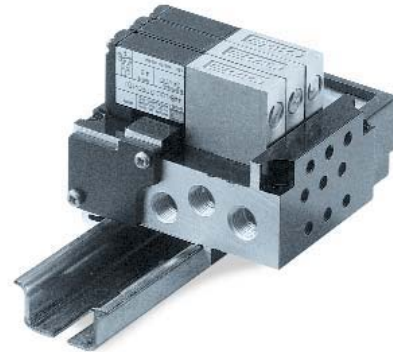

HOW TO ORDER

44B-xxx-GxxO-xxx

HOW TO ORDER VALVE FOR CIRCUIT BAR MOUNTING

Port size (see base)	Single operator
Valve less base	 <input type="radio"/> 44B-LOO-GxxO-xxx

SOLENOID OPERATOR >

G XX O - X XX*

XX Voltage	X Manual operator	XX Electrical connection
<input type="radio"/> DA 24VDC (1.0 W)	<input type="radio"/> 1 Non-locking	<input type="radio"/> DJ Plug-in
<input type="radio"/> DC 24VDC (1.8 W)		<input type="radio"/> DT Plug-in with light
<input type="radio"/> DD 24VDC (2.5 W)		<input type="radio"/> DE Plug-in with suppression diode
<input type="radio"/> DF 24VDC (4.0 W)		<input type="radio"/> DV Plug-in with light and suppression diode
<input type="radio"/> xx Other Options		<input type="radio"/> xx Other Options

ECF44B-00xxx-xxxx

HOW TO ORDER CIRCUIT BAR

Port size	Side cylinder ports (10.5 mm)
M5	<input type="radio"/> ECF44B-00BDB-zzxx
# 10-32	<input type="radio"/> ECF44B-00BBB-zzxx
4 mm tube receptacle	<input type="radio"/> ECF44B-00BEB-zzxx

Number of stations (03=3 stations)

Din rail spec. (EN50 022)

Note: clic for valves mounted on base at the factory (add - 9 to the model number).

L=Left Side; R=Right Side

ZZ Connector	ZZ Connector
<input type="radio"/> LA 9 Pin Sub D*	<input type="radio"/> RA 9 Pin Sub D*
<input type="radio"/> LB 15 Pin Sub D*	<input type="radio"/> RB 15 Pin Sub D*
<input type="radio"/> LC 25 Pin Sub D*	<input type="radio"/> RC 25 Pin Sub D*
<input type="radio"/> LD 10 Pin Ribbon Cable**	<input type="radio"/> RD 10 Pin Ribbon Cable**
<input type="radio"/> LE 16 Pin Ribbon Cable**	<input type="radio"/> RE 16 Pin Ribbon Cable**
<input type="radio"/> LF 20 Pin Ribbon Cable**	<input type="radio"/> RF 20 Pin Ribbon Cable**
<input type="radio"/> LG 26 Pin Ribbon Cable**	<input type="radio"/> RG 26 Pin Ribbon Cable**
<input type="radio"/> LH 3/8" NPSM Conduit Port Standard Base Wires	<input type="radio"/> RH 3/8" NPSM Conduit Port Standard Base Wires

* MIL. Spec; MIL-C-24308

** MIL. Spec; MIL-C-83503

Note: Left and right end is determined by facing conduit passage.

**TECHNICAL
DATA**

Fluid :	Compressed air, vacuum, inert gases
Pressure range :	Vacuum to 120 PSI
Lubrication :	Not required, if used select a medium aniline point lubricant (between 180°F and 210°F)
Filtration :	40 µ
Temperature range :	0°F to 120°F (-18°C to +50°C)
Orifice :	1.8 mm
Flow (at 6 bar, ΔP=1bar) :	4 W : 0.10 C _v , 2.5 W : 0.08 C _v , 1.8 W : 0.06 C _v , 1.0 W : 0.05 C _v
Coil :	General purpose class A, continuous duty, encapsulated
Voltage range :	-15% to +10% of nominal voltage
Power :	4 W - 2.5 W - 1.8 W - 1.0 W
Response times :	Energize : 4 ms
(with 4 W coil)	De-energize : 1.5 ms

- Note : • Valve and coil are not interchangeable.
- Spare parts : • Valve mounting kit : N-44001-03. • Blanking plate : M-44003. • Base wire Plug-in protector : 24180.
- Options : • Isolation of inlet and/or exhaust. • BSPP threads.

DIMENSIONS

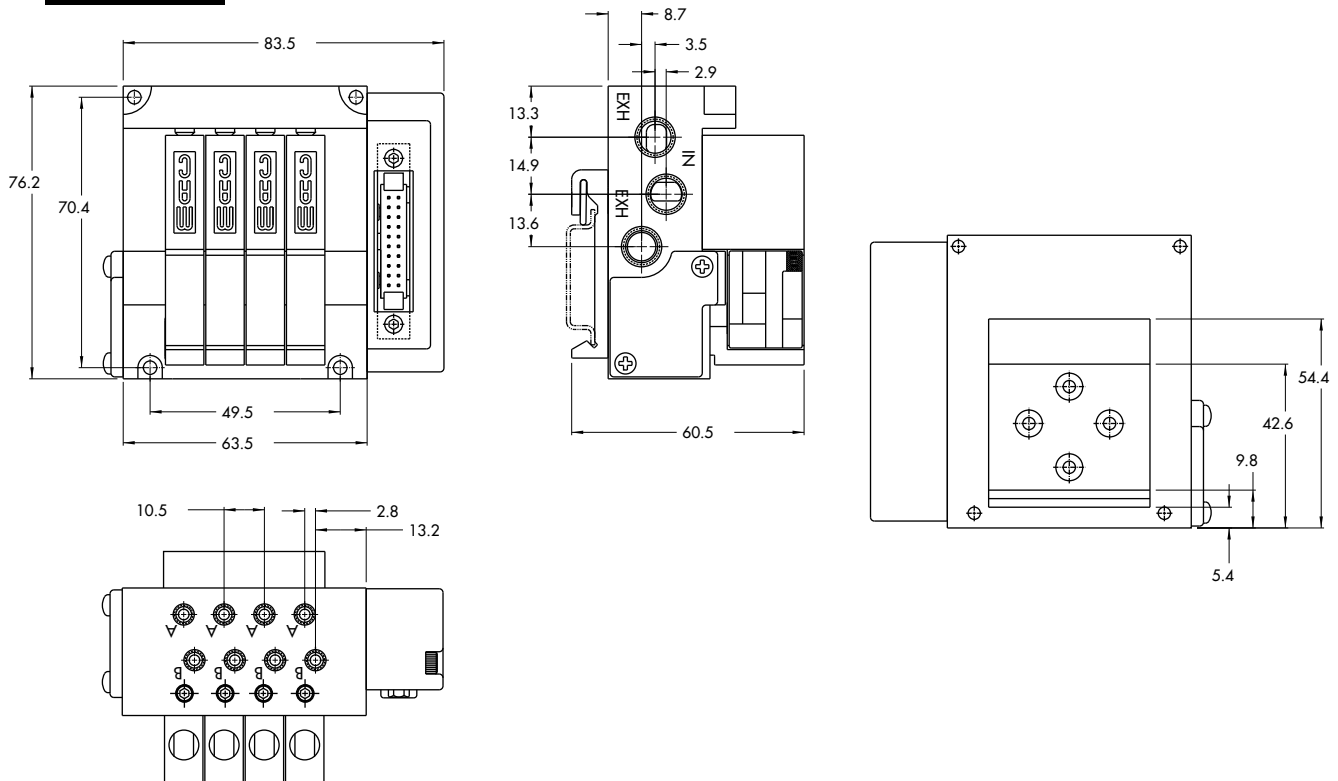



Section 2

Options



0 p t i o n s

Codification table for voltages / Manual operator / Electrical connection

VALVE CODE ► **-GXX X - X XX**
1 2 3 4

OPTIONS AVAILABLE FOR

- solenoid valves 34 & 44 Series

1. VOLTAGE (type 34 Series)		1. VOLTAGE (type 44 Series)	
-G XX X - X XX	VOLTAGE	-G XX X - X XX	VOLTAGE
<input type="radio"/> DC	24 VDC (1,8 W)	<input type="radio"/> DA	24 VDC (1,0 W)
<input type="radio"/> DD	24 VDC (2,5 W)	<input type="radio"/> DC	24 VDC (1,8 W)
<input type="radio"/> DE	24 VDC (3,0 W)	<input type="radio"/> DD	24 VDC (2,5 W)
<input type="radio"/> DF	24 VDC (4,0 W)	<input type="radio"/> DF	24 VDC (4,0 W)
<input type="radio"/> DJ	12 VDC (1,8 W)	<input type="radio"/> DG	12 VDC (1,0 W)
<input type="radio"/> DK	12 VDC (2,5 W)	<input type="radio"/> DJ	12 VDC (1,8 W)
<input type="radio"/> DM	12 VDC (3,0 W)	<input checked="" type="radio"/> DK	12 VDC (2,5 W)
<input type="radio"/> DN	12 VDC (4,0 W)	<input type="radio"/> DN	12 VDC (4,0 W)

2. WIRE LENGTH (Common options for 34 & 44 Series)	
-G XX X - X XX	WIRE LENGTH
<input type="radio"/> A	18"
<input type="radio"/> B	24"
<input type="radio"/> C	36"
<input checked="" type="radio"/> D	48"
<input type="radio"/> E	72"
<input type="radio"/> F	96"
<input type="radio"/> G	120"
<input type="radio"/> H	144"



3. MANUAL OPERATOR (COMMON OPTIONS FOR 34 & 44 SERIES)

-G XX X - X XX	MANUAL OPERATOR
1	Non-locking recessed
3	Non-locking extended

4. ELECTRICAL CONNECTION (COMMON OPTIONS FOR 34 & 44 SERIES)

-G XX X - X XX	NO CONNECTOR
<input type="radio"/> BA	Flying leads
<input type="radio"/> BB	BA with ground wire
<input type="radio"/> BC	BA with light
<input type="radio"/> BD	BA with light and ground wire
<input type="radio"/> BE	BA with suppression diode
<input type="radio"/> BF	BA with suppression diode and ground wire
<input type="radio"/> BG	BA with suppression diode and light
<input type="radio"/> BH	BA with suppression diode, light and ground wire
<input type="radio"/> BN	BA with suppression diode and blocking diode
<input checked="" type="radio"/> BP	BA with suppression diode, blocking diode and ground wire
<input type="radio"/> BR	BA with suppression diode, blocking diode and light
<input type="radio"/> BS	BA with suppression diode, blocking diode, light and ground wire
<input type="radio"/> BT	BA with light
<input type="radio"/> BU	BA with light and ground wire
<input type="radio"/> BV	BA with suppression diode and light
<input type="radio"/> BW	BA with suppression diode, light and ground wire
<input type="radio"/> BX	BA with suppression diode, blocking diode and light
<input type="radio"/> BY	BA with suppression diode, blocking diode, light and ground wire

-G XX X - X XX	PLUG-IN CONNECTOR
<input type="radio"/> KA	Mini connector with flying leads
<input type="radio"/> KB	KA with ground wire
<input type="radio"/> KE	KA with suppression diode
<input type="radio"/> KF	KA with suppression diode and ground wire
<input type="radio"/> KJ	Mini connector for KA option
<input type="radio"/> KM	Mini connector for KB option
<input type="radio"/> KN	KA with suppression diode and blocking diode
<input type="radio"/> KP	KA with suppression diode, blocking diode and ground wire
<input type="radio"/> KT	KA with light
<input type="radio"/> KU	KA with light and ground wire
<input type="radio"/> KV	KA with suppression diode and light
<input type="radio"/> KW	KA with suppression diode, light and ground wire
<input type="radio"/> KX	KA with suppression diode, blocking diode and light
<input type="radio"/> KY	KA with suppression diode, blocking diode, light and ground wire

MOD. S009

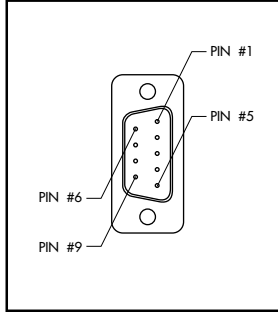

TECHNICAL DATA

- Type «SUB_D»
- Number of contacts : 9
- Solder termination (Dia. 0.6 mm/0.14 mm²/26-22 AWG)
- Operating current 5 A/contact
- Rated voltage 125 V~
- Temp. range -40° to +125°C
- Insulation resistance ≥ 5.0⁹ Ω
- Protection class IP40 (DIN 40050)
- Number of solenoids : 7 max.
- Max. 24 V=/5.4 W per solenoid
- 2 common wires

MOD. S015

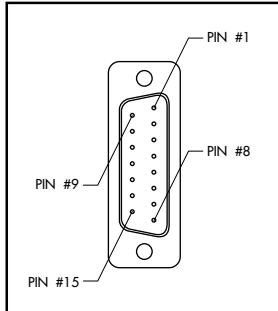

TECHNICAL DATA

- Type «SUB_D»
- Number of contacts : 15
- Solder termination (Dia. 0.6 mm/0.14 mm²/26-22 AWG)
- Operating current 5 A/contact
- Rated voltage 125 V~
- Temp. range -40° to +125°C
- Insulation resistance ≥ 5.0⁹ Ω
- Protection class IP40 (DIN 40050)
- Number of solenoids : 12 max.
- Max. 24 V=/5.4 W per solenoid
- 3 common wires

MOD. S025

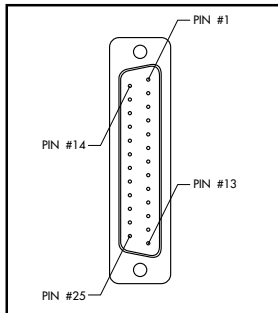

TECHNICAL DATA

- Type «SUB_D»
- Number of contacts : 25
- Solder termination (Dia. 0.6 mm/0.14 mm²/26-22 AWG)
- Operating current 5 A/contact
- Rated voltage 125 V~
- Temp. range -40° to +125°C
- Insulation resistance ≥ 5.0⁹ Ω
- Protection class IP40 (DIN 40050)
- Number of solenoids : 20 max.
- Max. 24 V=/5.4 W per solenoid
- 5 common wires

Note : Use desired MOD. number after circuit bar part number

Connector termination details

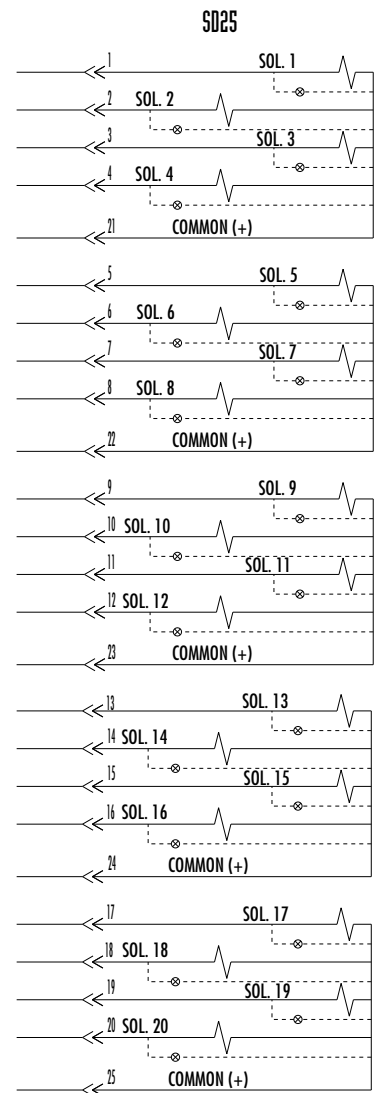
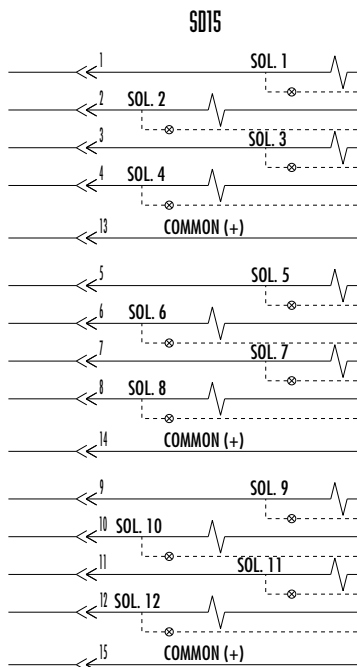
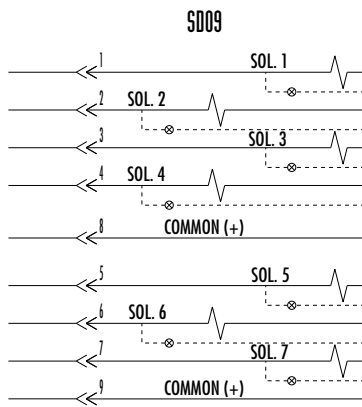
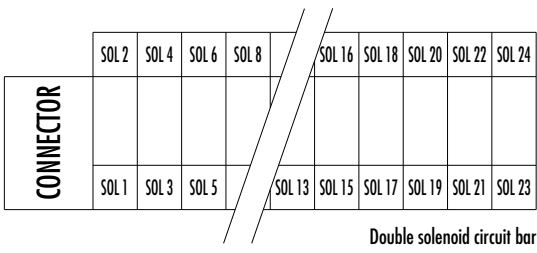
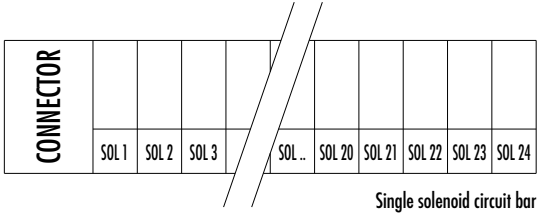

Circuit bar mounting

non plug-in with or without F. C.	non plug-in with Pr. Reg.	non plug-in with Pr. Reg. and F. C.	plug-in	plug-in with side Pr. Reg.	plug-in with sandwich Pr. Reg.	plug-in with F. C.	plug-in with Pr. Reg. and F. C.
plug-in with integral terminal strip	plug-in with integral terminal strip and side Pr. Reg.	plug-in with integral terminal strip and sandwich Pr. Reg.	plug-in with integral terminal strip with F. C.	plug-in with integral terminal strip with Pr. Reg. and F. C.			

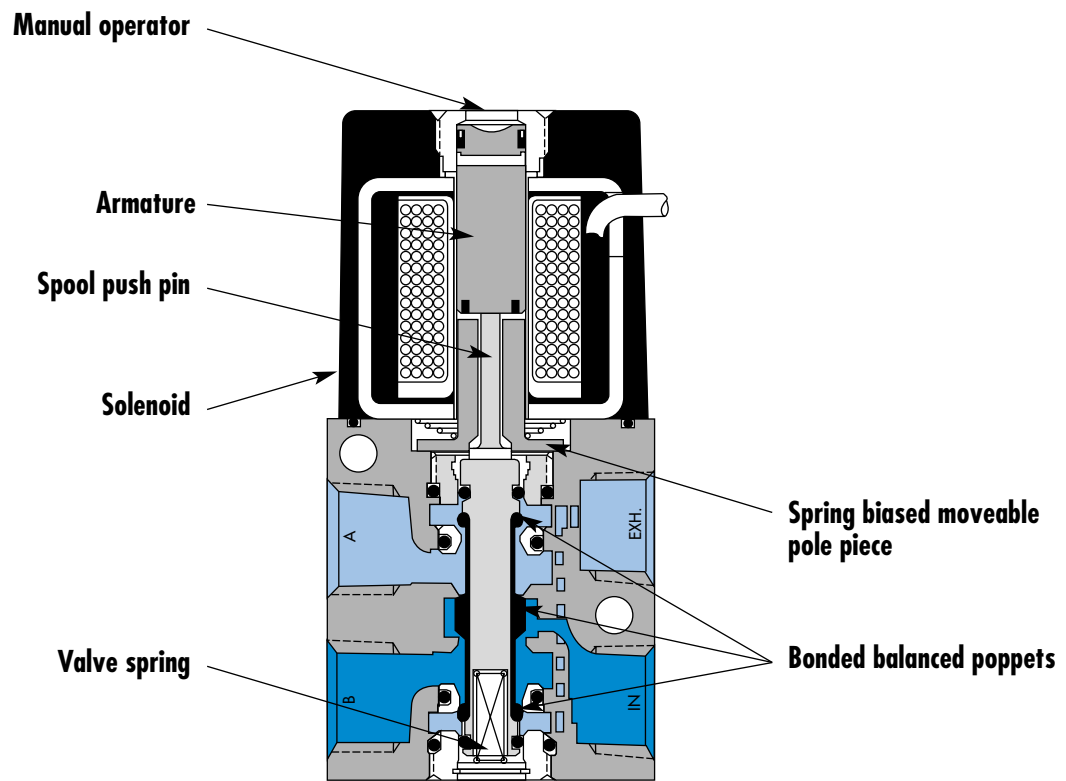

SERIES FEATURES

- Patented MACSOLENOID® for fastest possible response times.
- Extremely high cycle rate capability.
- Rated for lubricated or non-lubricated service.
- Various solenoid enclosures and plug-in connectors.
- Low wattage DC solenoids - down to 1.8 watts.

Function	Port size	Flow [Max]	Circuit bar mounting
4/2	1/8" NPTF - #10-32 UNF	0.10C_v	non plug-in with or without F. C.

OPERATIONAL BENEFITS

1. Balanced poppet, immune to variations of pressure.
2. Short stroke with high flow.
3. The patented solenoid develops high shifting forces.
4. Powerful return spring.
5. Manual operator standard on all valves.
6. Burn-out proof solenoid on AC service.



HOW TO ORDER

45A-xxx-Dxxx-xxx

HOW TO ORDER VALVE FOR CIRCUIT BAR MOUNTING

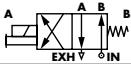
Single operator	Double operator (Minimum DC wattage 5,4W)
	
<input type="radio"/> 45A-L00-Dxxx-xxx	<input type="radio"/> 45A-N00-Dxxx-xxx

SOLENOID OPERATOR ▶

D XX X- X XX*

XX Voltage	X Wire length	X Manual operator	XX Electrical connection
<input type="radio"/> AA 120/60, 110/50	<input type="radio"/> A 18" (Flying leads)	<input type="radio"/> 1 Non-locking Recessed	<input type="radio"/> KA Square connector
<input type="radio"/> AB 240/60, 220/50	<input type="radio"/> J Connector	<input type="radio"/> 2 Locking Recessed	<input type="radio"/> KD Square connector with light
<input type="radio"/> AC 24/60, 24/50	<input type="radio"/> x Other Options	<input type="radio"/> x Other Options	<input type="radio"/> BA Flying leads
<input type="radio"/> FB 24VDC (1.8 W)			<input type="radio"/> xx Other Options
<input type="radio"/> DA 24VDC (5.4 W)			
<input type="radio"/> DF 24VDC (12.7 W)			
<input type="radio"/> xx Other Options			

EBM45A-xxxx-xx

HOW TO ORDER CIRCUIT BAR** (WITHOUT FLOW CONTROLS)

Port size	Spacing mm	Side cylinder ports	Bottom cylinder ports
1/8" NPTF	21	<input type="radio"/> EBM45A-001A-xx	<input type="radio"/> EBM45A-002A-xx
# 10-32 UNF	21	<input type="radio"/> EBM45A-001B-xx	<input type="radio"/> EBM45A-002B-xx

HOW TO ORDER CIRCUIT BAR** (WITH FLOW CONTROLS)

Port size	Spacing mm	Side cylinder ports	Bottom cylinder ports
1/8" NPTF	26	<input type="radio"/> EBM45A-015A-xx	<input type="radio"/> EBM45A-016A-xx
# 10-32 UNF	26	<input type="radio"/> EBM45A-015B-xx	<input type="radio"/> EBM45A-016B-xx
1/8" NPTF	40	<input type="radio"/> EBM45A-025A-xx	<input type="radio"/> EBM45A-026A-xx
# 10-32 UNF	40	<input type="radio"/> EBM45A-025B-xx	<input type="radio"/> EBM45A-026B-xx

Number of stations (03=3 stations)

** Other options available Consult factory.

Note : clic for valves mounted on base at the factory (add - 9 to the model number).

Consult "Precautions" before use, installation or service of MAC Valves.

**TECHNICAL
DATA**

Fluid :	Compressed air, vacuum, inert gases		
Pressure range :	Vacuum to 120 PSI		
Lubrication :	Not required, if used select a medium aniline point lubricant (between 180°F and 210°F)		
Filtration :	40 µ		
Temperature range :	0°F to 120°F (-18°C to 50°C)		
Orifice :	2 mm		
Flow (at 6 bar, ΔP=1bar) :	1.8 W : 0.08 C _v , 5.4 W : 0.1 C _v		
Coil :	General purpose class A, continuous duty, encapsulated		
Voltage range :	-15% to +10% of nominal voltage		
Protection :	Nema 4		
Power :	120 VAC/60 = Inrush : 10.9 VA (0.09 AMPS) Holding : 7.7VA (0.06 AMPS) DC VOLTS = 1.8 W to 12.7 W		
Response times :	24 VDC (5.4W)	Energize : 6 ms	De-energize : 2 ms
	120 VAC	Energize : 3-8 ms	De-energize : 2-7 ms

- Spare parts :
- Solenoid operator (power ≥ 5.4 W) : DXXJ-XFM, including mounting screws 35013.
 - Seal between solenoid and valve body : 16402. • Seal between base and valve : 16453.
 - Valve mounting screw (x2) : 35020. • Blanking plate valve : M-45010. • Blanking plate regulator : M-35005.

- Options :
- BSPP threads. • High flow up to 0.14C_v, according to wattage. • Isolation of inlet and/or exhaust.

DIMENSIONS

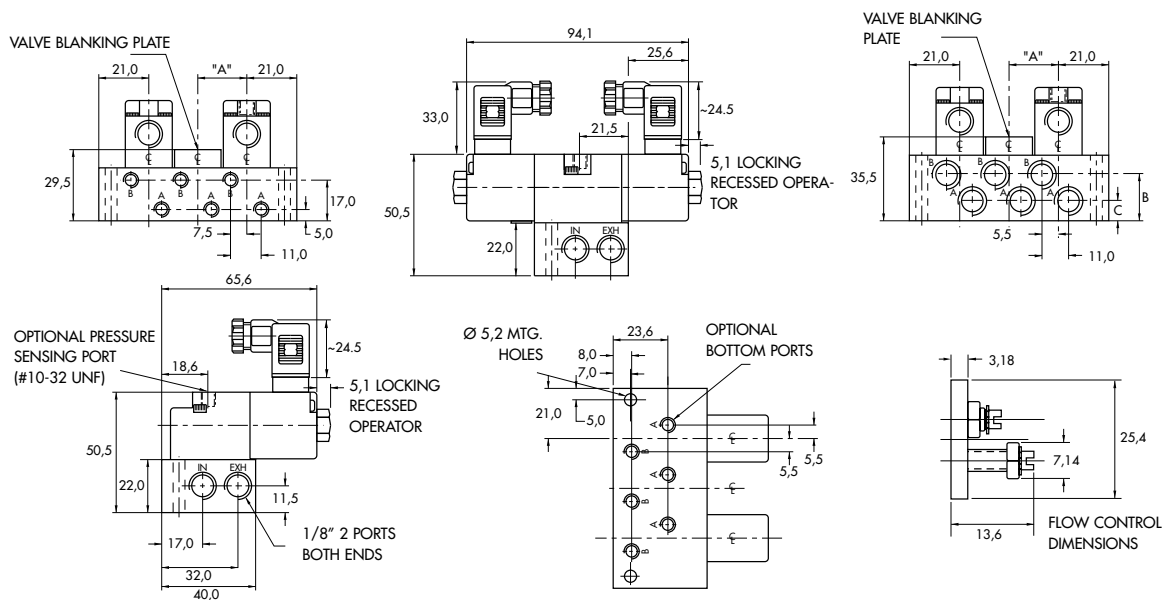

SPACING SIZE	A	PORT SIZE	B	C
STANDARD	21.0			
PER JB	26.0	1/8"	20.0	8.0
GAGES	40.0	M5	22.0	6.0

Function	Port size	Flow [Max]	Circuit bar mounting
4/2	1/8" NPTF - #10-32 UNF	0.10C_v	non plug-in with Pr. Reg.

OPERATIONAL BENEFITS

1. Balanced poppet, immune to variations of pressure.
2. Short stroke with high flow.
3. The patented solenoid develops high shifting forces.
4. Powerful return spring.
5. Manual operator standard on all valves.
6. Burn-out proof solenoid on AC service.



HOW TO ORDER

45A-xxx-Dxxx-xxx

HOW TO ORDER VALVE FOR CIRCUIT BAR MOUNTING

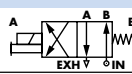
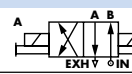
	Single operator	Double operator (Minimum DC wattage 5,4W)
		
Valve w/o gage port	<input type="radio"/> 45A-L00-Dxxx-xxx	<input type="radio"/> 45A-N00-Dxxx-xxx
Valve w/ gage port	<input type="radio"/> 45A-M00-Dxxx-xxx	<input type="radio"/> 45A-P00-Dxxx-xxx

SOLENOID OPERATOR >

D **XX X- X XX**

XX	Voltage	X	Wire length	X	Manual operator	XX	Electrical connection
<input type="radio"/> AA	120/60, 110/50	<input type="radio"/> A	18" (Flying leads)	<input type="radio"/> 1	Non-locking Recessed	<input type="radio"/> KA	Square connector
<input type="radio"/> AB	240/60, 220/50	<input type="radio"/> J	Connector	<input type="radio"/> 2	Locking Recessed	<input type="radio"/> KD	Square connector with light
<input type="radio"/> AC	24/60, 24/50	<input type="radio"/> x	Other Options	<input type="radio"/> x	Other Options	<input type="radio"/> BA	Flying leads
<input type="radio"/> FB	24VDC (1.8 W)					<input type="radio"/> xx	Other Options
<input type="radio"/> DA	24VDC (5.4 W)						
<input type="radio"/> DF	24VDC (12.7 W)						
<input type="radio"/> xx	Other Options						

EBM45A-xxxx-xx

HOW TO ORDER CIRCUIT BAR WITH PRESSURE REGULATORS (ORDER REGULATORS SEPARATELY) **

Port size	Spacing mm	Side cylinder ports	Bottom cylinder ports
1/8" NPTF	21 (w/o gage)	<input type="radio"/> EBM45A-003A-xx	<input type="radio"/> EBM45A-004A-xx
# 10-32 UNF	21 (w/o gage)	<input type="radio"/> EBM45A-003B-xx	<input type="radio"/> EBM45A-004B-xx
1/8" NPTF	40 (w/ gage)	<input type="radio"/> EBM45A-023A-xx	<input type="radio"/> EBM45A-024A-xx
# 10-32 UNF	40 (w/ gage)	<input type="radio"/> EBM45A-023B-xx	<input type="radio"/> EBM45A-024B-xx

Number of stations (03=3 stations)

** Other options available Consult factory.

Note : clic for valves and regulators mounted to circuit bar at the factory (add - 9 to the model number).
gage not supplied w/circuit bar.

Pressure regulators :
35A-00M (Adjusting knob)
35A-00L (Slotted stem)
35A-00U (Locking stem)

**TECHNICAL
DATA**

Fluid :	Compressed air, vacuum, inert gases
Pressure range :	Vacuum to 120 PSI
Lubrication :	Not required, if used select a medium aniline point lubricant (between 180°F and 210°F)
Filtration :	40 µ
Temperature range :	0°F to 120°F (-18°C to 50°C)
Orifice :	2 mm
Flow (at 6 bar, ΔP=1bar) :	1.8 W : 0.08 C _v , 5.4 W : 0.1 C _v
Coil :	General purpose class A, continuous duty, encapsulated
Voltage range :	-15% to +10% of nominal voltage
Protection :	Nema 4
Power :	120 VAC/60 = Inrush : 10.9 VA (0.09 AMPS) Holding : 7.7VA (0.06 AMPS) DC VOLTS = 1.8 W to 12.7 W
Response times :	24 VDC (5.4W) Energize : 6 ms De-energize : 2 ms 120 VAC Energize : 3-8 ms De-energize : 2-7 ms

Spare parts :

- Solenoid operator (power ≥ 5.4 W) : DXXJ-XFM, including mounting screws 35013.
- Seal between solenoid and valve body : 16402. • Seal between base and valve : 16453.
- Valve mounting screw (x2) : 35020. • Blanking plate valve : M-45010. • Blanking plate regulator : M-35005.

Options :

- BSPP threads. • High flow up to 0.14C_v, according to wattage. • Isolation of inlet and/or exhaust.

DIMENSIONS

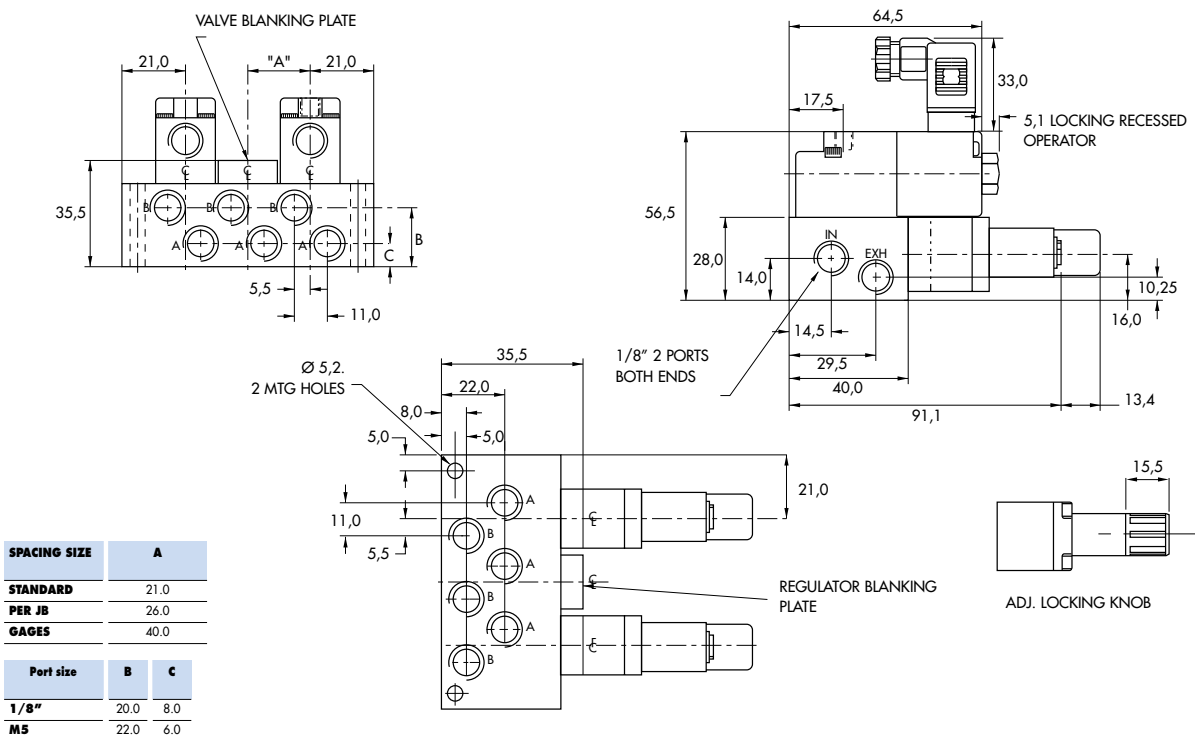

Function	Port size	Flow [Max]	Circuit bar mounting
4/2	1/8" NPTF - #10-32 UNF	0.10C_v	non plug-in with Pr. Reg. and F. C.

OPERATIONAL BENEFITS

1. Balanced poppet, immune to variations of pressure.
2. Short stroke with high flow.
3. The patented solenoid develops high shifting forces.
4. Powerful return spring.
5. Manual operator standard on all valves.
6. Burn-out proof solenoid on AC service.

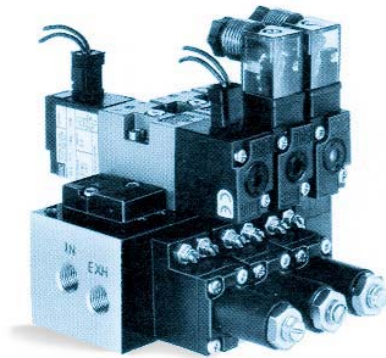

HOW TO ORDER

45A-xxx-Dxxx-xxx

HOW TO ORDER VALVE FOR CIRCUIT BAR MOUNTING

	Single operator	Double operator (Minimum DC wattage 5,4W)
Valve w/o gage port	<input type="radio"/> 45A-L00-Dxxx-xxx	<input type="radio"/> 45A-N00-Dxxx-xxx
Valve w/ gage port	<input type="radio"/> 45A-M00-Dxxx-xxx	<input type="radio"/> 45A-P00-Dxxx-xxx

SOLENOID OPERATOR >

D **XX X- X XX***

XX Voltage	X Wire length	X Manual operator	XX Electrical connection
<input type="radio"/> AA 120/60, 110/50	<input type="radio"/> A 18" (Flying leads)	<input type="radio"/> 1 Non-locking Recessed	<input type="radio"/> KA Square connector
<input type="radio"/> AB 240/60, 220/50	<input type="radio"/> J Connector	<input type="radio"/> 2 Locking Recessed	<input type="radio"/> KD Square connector with light
<input type="radio"/> AC 24/60, 24/50	<input type="radio"/> x Other Options	<input type="radio"/> x Other Options	<input type="radio"/> BA Flying leads
<input type="radio"/> FB 24VDC (1.8 W)			<input type="radio"/> xx Other Options
<input type="radio"/> DA 24VDC (5.4 W)			
<input type="radio"/> DF 24VDC (12.7 W)			
<input type="radio"/> xx Other Options			

EBM45A-xxxx-xx

HOW TO ORDER CIRCUIT BAR WITH PRESSURE REGULATORS AND FLOW CONTROLS (ORDER REGULATOR AND FLOW CONTROL SEPARATELY) **

Port size	Spacing mm	Side cylinder ports	Bottom cylinder ports
1/8" NPTF	21 (w/o gage)	<input type="radio"/> EBM45A-007A-xx	<input type="radio"/> EBM45A-008A-xx
# 10-32 UNF	21 (w/o gage)	<input type="radio"/> EBM45A-007B-xx	<input type="radio"/> EBM45A-008B-xx
1/8" NPTF	40 (w/ gage)	<input type="radio"/> EBM45A-027A-xx	<input type="radio"/> EBM45A-028A-xx
# 10-32 UNF	40 (w/ gage)	<input type="radio"/> EBM45A-027B-xx	<input type="radio"/> EBM45A-028B-xx

Number of stations (03=3 stations)

** Other options available Consult factory.

Note : clic for valves, regulators and flow controls mounted to circuit bar at the factory (add - 9 to the model number).
gage not supplied w/circuit bar

Pressure regulators and flow controls:
45A-001 (Slotted stem)
45A-002 (Adjusting knob)
45A-003 (Locking stem)

**TECHNICAL
DATA**

Fluid :	Compressed air, vacuum, inert gases		
Pressure range :	Vacuum to 120 PSI		
Lubrication :	Not required, if used select a medium aniline point lubricant (between 180°F and 210°F)		
Filtration :	40 µ		
Temperature range :	0°F to 120°F (-18°C to 50°C)		
Orifice :	2 mm		
Flow (at 6 bar, ΔP=1bar) :	1.8 W : 0.08 C _v , 5.4 W : 0.1 C _v		
Coil :	General purpose class A, continuous duty, encapsulated		
Voltage range :	-15% to +10% of nominal voltage		
Protection :	Nema 4		
Power :	120 VAC/60 = Inrush : 10.9 VA (0.09 AMPS) Holding : 7.7VA (0.06 AMPS) DC VOLTS = 1.8 W to 12.7 W		
Response times :	24 VDC (5.4W)	Energize : 6 ms	De-energize : 2 ms
	120 VAC	Energize : 3-8 ms	De-energize : 2-7 ms

Spare parts :

- Solenoid operator (power ≥ 5.4 W) : DXJ-XFM, including mounting screws 35013.
- Seal between solenoid and valve body : 16402. • Seal between base and valve : 16453.
- Valve mounting screw (x2) : 35020. • Blanking plate valve : M-45010. • Blanking plate regulator : M-35005.

Options :

- BSPP threads. • High flow up to 0.14C_v, according to wattage. • Isolation of inlet and/or exhaust.

DIMENSIONS

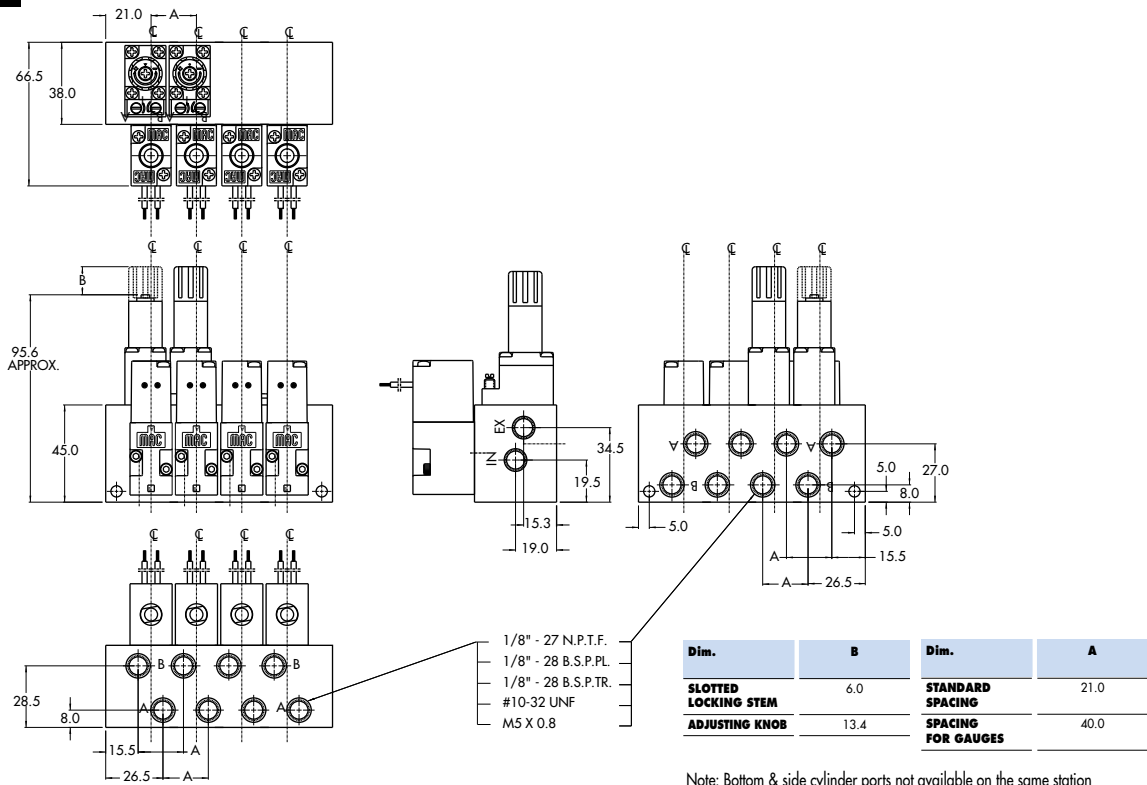

Note: Bottom & side cylinder ports not available on the same station

Function	Port size	Flow [Max]	Circuit bar mounting
4/2	1/8" NPTF - #10-32 UNF	0.10C_v	plug-in

OPERATIONAL BENEFITS

1. Balanced poppet, immune to variations of pressure.
2. Short stroke with high flow.
3. The patented solenoid develops high shifting forces.
4. Powerful return spring.
5. Manual operator standard on all valves.
6. Burn-out proof solenoid on AC service.

Reset



HOW TO ORDER

45A-xxx-DxxJ-xFM

HOW TO ORDER VALVE FOR CIRCUIT BAR MOUNTING "PLUG-IN"

Single operator	Double operator (Minimum DC wattage 5,4W)
<input type="radio"/> 45A-L00-DxxJ-xFM	<input type="radio"/> 45A-N00-DxxJ-xFM

SOLENOID OPERATOR >

D xx J- x FM

XX Voltage	X Manual operator
<input type="radio"/> AA 120/60, 110/50	<input type="radio"/> 1 Non-locking Recessed
<input type="radio"/> AB 240/60, 220/50	<input type="radio"/> 2 Locking Recessed
<input type="radio"/> AC 24/60, 24/50	<input type="radio"/> x Other Options
<input type="radio"/> FB 24VDC (1.8 W)	
<input type="radio"/> DA 24VDC (5.4 W)	
<input type="radio"/> DF 24VDC (12.7 W)	
<input type="radio"/> xx Other Options	

ECD45A-xxxx-xx-xx

HOW TO ORDER "PLUG-IN" CIRCUIT BAR**

Port size	Spacing mm	Side cylinder ports	Bottom cylinder ports
1/8" NPTF	21	<input type="radio"/> ECD45A-001A-A0-xx	<input type="radio"/> ECD45A-002A-A0-xx
# 10-32 UNF	21	<input type="radio"/> ECD45A-001B-A0-xx	<input type="radio"/> ECD45A-002B-A0-xx
1/8" NPTF	30	<input type="radio"/> ECD45A-031A-C0-xx	<input type="radio"/> ECD45A-032A-C0-xx
# 10-32 UNF	30	<input type="radio"/> ECD45A-031B-C0-xx	<input type="radio"/> ECD45A-032B-C0-xx

Number of stations (03=3 stations)

Note: clic for valves mounted on base at the factory (add - 9 to the model number).
for multi-pin connector (9, 15 or 25).

- A0 = without light
- AA = with light (120V)
- AB = with light (240V)
- AD = with light (24V)
- C0 = terminal strip
- CA = terminal w/light (120V)
- CB = terminal w/light (240V)
- CD = terminal w/light (24V)

OPTIONS

ECD45A-002A-A0-xx

- clic for double operator valve (replace by 8) (Bottom cylinder ports).

**TECHNICAL
DATA**

Fluid :	Compressed air, vacuum, inert gases		
Pressure range :	Vacuum to 120 PSI		
Lubrication :	Not required, if used select a medium aniline point lubricant (between 180°F and 210°F)		
Filtration :	40 µ		
Temperature range :	0°F to 120°F (-18°C to 50°C)		
Orifice :	2 mm		
Flow (at 6 bar, ΔP=1bar) :	1.8 W : 0.08 C _v , 5.4 W : 0.1 C _v		
Coil :	General purpose class A, continuous duty, encapsulated		
Voltage range :	-15% to +10% of nominal voltage		
Protection :	Nema 4		
Power :	120 VAC/60 = Inrush : 10.9 VA (0.09 AMPS) Holding : 7.7VA (0.06 AMPS) DC VOLTS = 1.8 W to 12.7 W		
Response times :	24 VDC (5.4W)	Energize : 6 ms	De-energize : 2 ms
	120 VAC	Energize : 3-8 ms	De-energize : 2-7 ms

- Spare parts :
- Solenoid operator (power ≥ 5.4 W) : DXXJ-XFM, including mounting screws 35013.
 - Seal between solenoid and valve body : 16402. • Seal between base and valve : 16453.
 - Valve mounting screw (x2) : 35020. • Blanking plate valve : M-45010. • Blanking plate regulator : M-35005.

- Options :
- BSPP threads. • High flow up to 0.14C_v, according to wattage. • Isolation of inlet and/or exhaust.

DIMENSIONS

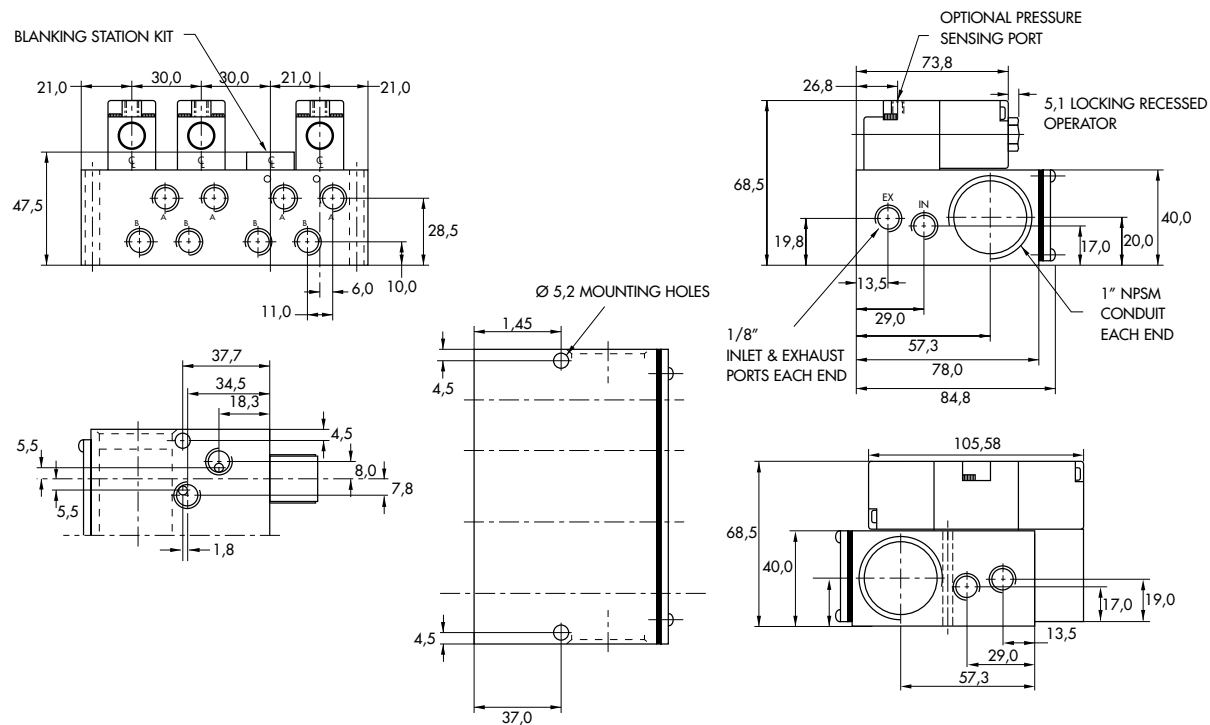

Function	Port size	Flow [Max]	Circuit bar mounting
4/2	1/8" NPTF - #10-32 UNF	0.10C_v	plug-in with side Pr. Reg.

OPERATIONAL BENEFITS

1. Balanced poppet, immune to variations of pressure.
2. Short stroke with high flow.
3. The patented solenoid develops high shifting forces.
4. Powerful return spring.
5. Manual operator standard on all valves.
6. Burn-out proof solenoid on AC service.

Reset

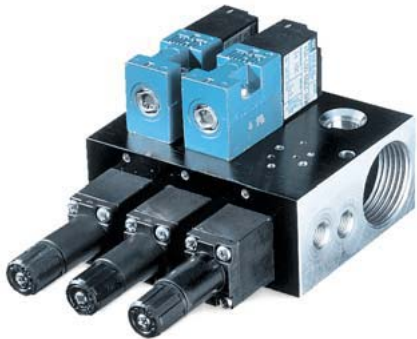

HOW TO ORDER

45A-xxx-DxxJ-xFM

HOW TO ORDER VALVE FOR "PLUG-IN" CIRCUIT BAR

Single operator	
<input type="radio"/> 45A-L00-DxxJ-xFM	Valve w/o gage port
<input type="radio"/> 45A-M00-DxxJ-xFM	Valve w/ gage port

SOLENOID OPERATOR >

D xx J- x FM*

XX Voltage	X Manual operator
<input type="radio"/> AA 120/60, 110/50	<input type="radio"/> 1 Non-locking Recessed
<input type="radio"/> AB 240/60, 220/50	<input type="radio"/> 2 Locking Recessed
<input type="radio"/> AC 24/60, 24/50	<input type="radio"/> x Other Options
<input type="radio"/> FB 24VDC (1.8 W)	
<input type="radio"/> DA 24VDC (5.4 W)	
<input type="radio"/> DF 24VDC (12.7 W)	
<input type="radio"/> xx Other Options	

ECD45A-xxxx-xx-xx

HOW TO ORDER CIRCUIT BAR WITH PRESSURE REGULATORS (TO BE ORDERED SEPARATELY) **

Port size	Spacing mm	Bottom cylinder ports
1/8" NPTF	21	<input type="radio"/> ECD45A-004A-A0-xx
# 10-32 UNF	21	<input type="radio"/> ECD45A-004B-A0-xx
1/8" NPTF	30	<input type="radio"/> ECD45A-034A-C0-xx
# 10-32 UNF	30	<input type="radio"/> ECD45A-034B-C0-xx
1/8" NPTF	40	<input type="radio"/> ECD45A-024A-A0-xx
# 10-32 UNF	40	<input type="radio"/> ECD45A-024B-A0-xx

Number of stations (03=3 stations)
 Note: clic for valves and regulators mounted to circuit bar at the factory (add - 9 to the model number).
 for multi-pin connector (9, 15 or 25).
 minimum spacing for terminal strips is 30 mm.
 use 40 mm spacing for gages.

** Pressure Regulators :
 35A-00M (Adjusting knob)
 35A-00L (Slotted stem)
 35A-00U (Locking stem)

- A0 = without light
- AA = with light (120V)
- AB = with light (240V)
- AD = with light (24V)
- C0 = terminal strip
- CA = terminal w/light (120V)
- CB = terminal w/light (240V)
- CD = terminal w/light (24V)

**TECHNICAL
DATA**

Fluid :	Compressed air, vacuum, inert gases
Pressure range :	Vacuum to 120 PSI
Lubrication :	Not required, if used select a medium aniline point lubricant (between 180°F and 210°F)
Filtration :	40 µ
Temperature range :	0°F to 120°F (-18°C to 50°C)
Orifice :	2 mm
Flow (at 6 bar, ΔP=1bar) :	1.8 W : 0.08 C _v , 5.4 W : 0.1 C _v
Coil :	General purpose class A, continuous duty, encapsulated
Voltage range :	-15% to +10% of nominal voltage
Protection :	Nema 4
Power :	120 VAC/60 = Inrush : 10.9 VA (0.09 AMPS) Holding : 7.7VA (0.06 AMPS) DC VOLTS = 1.8 W to 12.7 W
Response times :	24 VDC (5.4W) Energize : 6 ms De-energize : 2 ms 120 VAC Energize : 3-8 ms De-energize : 2-7 ms

Spare parts :

- Solenoid operator (power ≥ 5.4 W) : DXXJ-XFM, including mounting screws 35013.
- Seal between solenoid and valve body : 16402. • Seal between base and valve : 16453.
- Valve mounting screw (x2) : 35020. • Blanking plate valve : M-45010. • Blanking plate regulator : M-35005.

Options :

- BSPP threads. • High flow up to 0.14C_v, according to wattage. • Isolation of inlet and/or exhaust.

DIMENSIONS

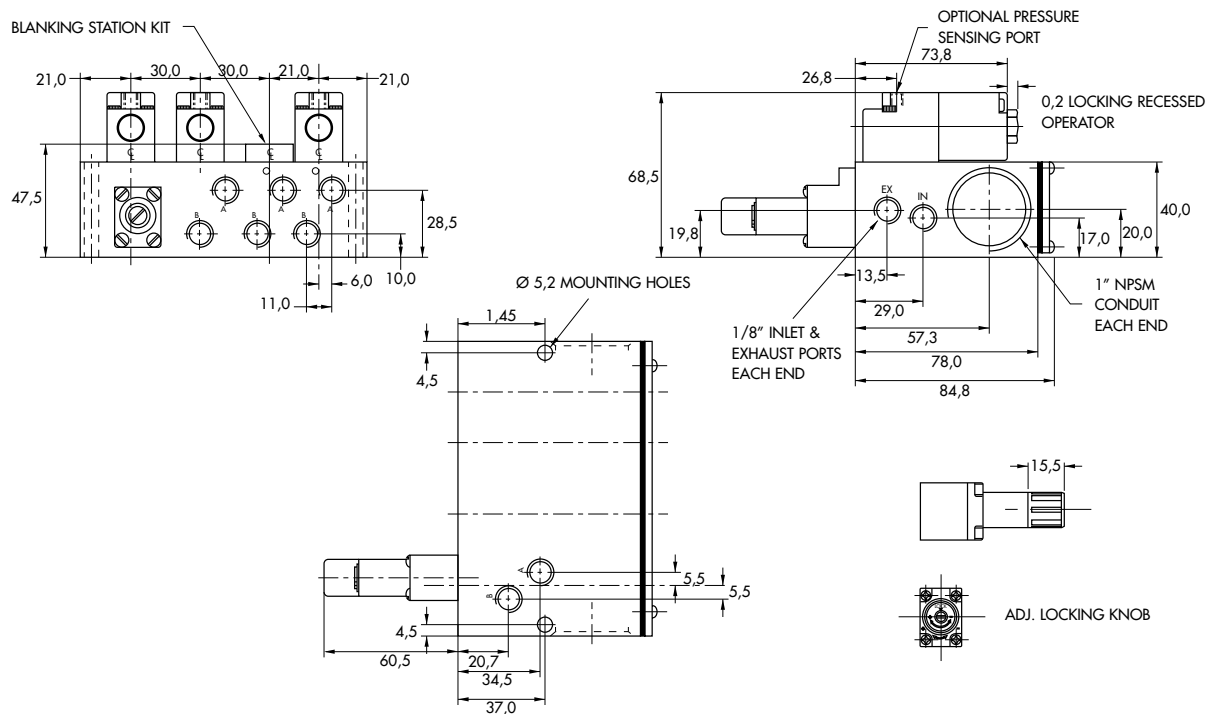

Function	Port size	Flow [Max]	Circuit bar mounting
4/2	1/8" NPTF - #10-32 UNF	0.10C_v	plug-in with sandwich Pr. Reg.

OPERATIONAL BENEFITS

- Balanced poppet, immune to variations of pressure.
- Short stroke with high flow.
- The patented solenoid develops high shifting forces.
- Powerful return spring.
- Manual operator standard on all valves.
- Burn-out proof solenoid on AC service.

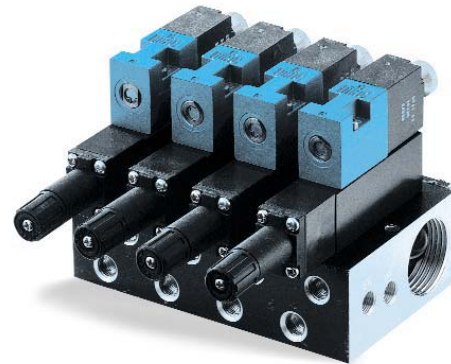

HOW TO ORDER

45A-xxx-DxxJ-xFM

HOW TO ORDER VALVE FOR CIRCUIT BAR MOUNTING "PLUG-IN"

Single operator

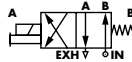

<input type="radio"/> 45A-L00-DxxJ-xFM	Valve w/o gage port
<input type="radio"/> 45A-M00-DxxJ-xFM	Valve w/ gage port

SOLENOID OPERATOR >

D xx J- x FM*

XX Voltage	X Manual operator
<input type="radio"/> AA 120/60, 110/50	<input type="radio"/> 1 Non-locking Recessed
<input type="radio"/> AB 240/60, 220/50	<input type="radio"/> 2 Locking Recessed
<input type="radio"/> AC 24/60, 24/50	<input type="radio"/> x Other Options
<input type="radio"/> FB 24VDC (1.8 W)	
<input type="radio"/> DA 24VDC (5.4 W)	
<input type="radio"/> DF 24VDC (12.7 W)	
<input type="radio"/> xx Other Options	

ECD45A-xxxx-xx-xx

HOW TO ORDER "PLUG-IN" CIRCUIT BAR WITH SANDWICH PRESSURE REGULATORS (TO BE ORDERED SEPARATELY) **

Port size	Spacing mm	Side cylinder ports	Bottom cylinder ports
1/8" NPTF	21	<input type="radio"/> ECD45A-001A-A0-xx	<input type="radio"/> ECD45A-002A-A0-xx
# 10-32 UNF	21	<input type="radio"/> ECD45A-001B-A0-xx	<input type="radio"/> ECD45A-002B-A0-xx
1/8" NPTF	30	<input type="radio"/> ECD45A-031A-C0-xx	<input type="radio"/> ECD45A-032A-C0-xx
# 10-32 UNF	30	<input type="radio"/> ECD45A-031B-C0-xx	<input type="radio"/> ECD45A-032B-C0-xx
1/8" NPTF	40	<input type="radio"/> ECD45A-021A-A0-xx	<input type="radio"/> ECD45A-022A-A0-xx
# 10-32 UNF	40	<input type="radio"/> ECD45A-021B-A0-xx	<input type="radio"/> ECD45A-022B-A0-xx

Number of stations (03=3 stations)
 Note: clic for valves and regulators mounted to circuit bar at the factory, add - 9 to the model number.
 for multi-pin connector (9, 15 or 25).
 minimum spacing for terminal strips is 30 mm.
 use 40 mm spacing for gages.

** Pressure Regulators :
 PR45A-AA0A (Adjusting knob)
 PR45A-AB0A (Slotted stem)
 PR45A-AC0A (Locking stem)

- A0 = without light
- AA = with light (120V)
- AB = with light (240V)
- AD = with light (24V)
- C0 = terminal strip
- CA = terminal w/light (120V)
- CB = terminal w/light (240V)
- CD = terminal w/light (24V)

**TECHNICAL
DATA**

Fluid :	Compressed air, vacuum, inert gases		
Pressure range :	Vacuum to 120 PSI		
Lubrication :	Not required, if used select a medium aniline point lubricant (between 180°F and 210°F)		
Filtration :	40 µ		
Temperature range :	0°F to 120°F (-18°C to 50°C)		
Orifice :	2 mm		
Flow (at 6 bar, ΔP=1bar) :	1.8 W : 0.08 C _v , 5.4 W : 0.1 C _v		
Coil :	General purpose class A, continuous duty, encapsulated		
Voltage range :	-15% to +10% of nominal voltage		
Protection :	Nema 4		
Power :	120 VAC/60 = Inrush : 10.9 VA (0.09 AMPS) Holding : 7.7VA (0.06 AMPS) DC VOLTS = 1.8 W to 12.7 W		
Response times :	24 VDC (5.4W)	Energize : 6 ms	De-energize : 2 ms
	120 VAC	Energize : 3-8 ms	De-energize : 2-7 ms

Spare parts :

- Solenoid operator (power ≥ 5.4 W) : DXXJ-XFM, including mounting screws 35013.
- Seal between solenoid and valve body : 16402. • Seal between base and valve : 16453.
- Valve mounting screw (x2) : 35020. • Blanking plate valve : M-45010. • Blanking plate regulator : M-35005.

Options :

- BSPP threads. • High flow up to 0.14C_v, according to wattage. • Isolation of inlet and/or exhaust.

DIMENSIONS

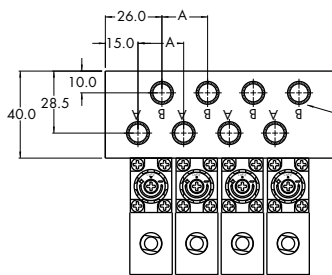

- 1/8" - 27 N.P.T.F.
- 1/8" - 28 B.S.P.PL.
- 1/8" - 28 B.S.P.TR.
- #10-32
- M5 0.8

Dim.	A	Dim.	B
STANDARD SPACING	21.0	SLOTTED LOCKING STEM	6.0
OPTIONAL SPACING	30.0	ADJUSTING KNOB	13.4
SPACING FOR GAUGES	40.0		

Note: Bottom & side cylinder ports not available on the same station

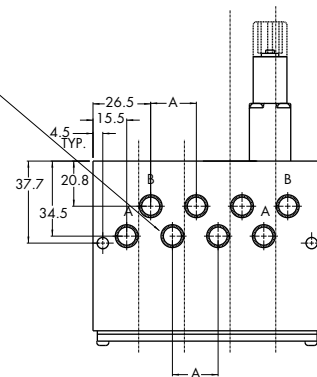
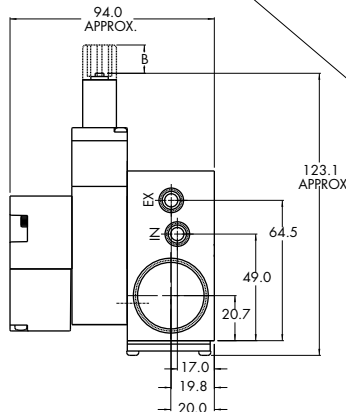
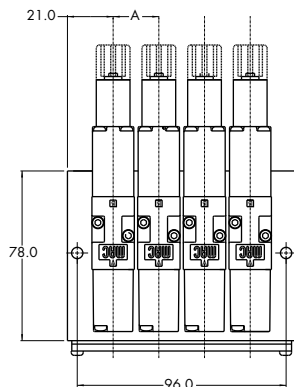

Function	Port size	Flow [Max]	Circuit bar mounting
4/2	1/8" NPTF - #10-32 UNF	0.10C_v	plug-in with F. C.

OPERATIONAL BENEFITS

1. Balanced poppet, immune to variations of pressure.
2. Short stroke with high flow.
3. The patented solenoid develops high shifting forces.
4. Powerful return spring.
5. Manual operator standard on all valves.
6. Burn-out proof solenoid on AC service.



HOW TO ORDER

45A-xxx-DxxJ-xFM

HOW TO ORDER VALVE FOR CIRCUIT BAR MOUNTING "PLUG-IN"

Port size (see base)	Single operator
Valve less base	 <input type="radio"/> 45A-L00-DxxJ-xFM

SOLENOID OPERATOR >

D XX J- x FM*

XX Voltage	x Manual operator
<input type="radio"/> AA 120/60, 110/50	<input type="radio"/> 1 Non-locking Recessed
<input type="radio"/> AB 240/60, 220/50	<input type="radio"/> 2 Locking Recessed
<input type="radio"/> AC 24/60, 24/50	<input type="radio"/> x Other Options
<input type="radio"/> FB 24VDC (1.8 W)	
<input type="radio"/> DA 24VDC (5.4 W)	
<input type="radio"/> DF 24VDC (12.7 W)	
<input type="radio"/> xx Other Options	

ECD45A-xxxx-xx-xx

HOW TO ORDER "PLUG-IN" CIRCUIT BAR WITH FLOW CONTROLS **

Port size	Spacing mm	Side cylinder ports	Bottom cylinder ports
1/8" NPTF	21	-----	<input type="radio"/> ECD45A-006A-A0-xx
# 10-32 UNF	21	-----	<input type="radio"/> ECD45A-006B-A0-xx
1/8" NPTF	30	<input type="radio"/> ECD45A-035A-A0-xx	-----
# 10-32 UNF	30	<input type="radio"/> ECD45A-035B-A0-xx	-----

Number of stations (03=3 stations)

Note : clic for valves mounted on base at the factory (add - 9 to the model number).
 for multi-pin connector (9, 15 or 25).
 minimum spacing for terminal strips is 30 mm.

- A0 = without light
- AA = with light (120V)
- AB = with light (240V)
- AD = with light (24V)
- C0 = terminal strip
- CA = terminal w/light (120V)
- CB = terminal w/light (240V)
- CD = terminal w/light (24V)

TECHNICAL DATA

Fluid :	Compressed air, vacuum, inert gases		
Pressure range :	Vacuum to 120 PSI		
Lubrication :	Not required, if used select a medium aniline point lubricant (between 180°F and 210°F)		
Filtration :	40 µ		
Temperature range :	0°F to 120°F (-18°C to 50°C)		
Orifice :	2 mm		
Flow (at 6 bar, ΔP=1bar) :	1.8 W : 0.08 C _v , 5.4 W : 0.1 C _v		
Coil :	General purpose class A, continuous duty, encapsulated		
Voltage range :	-15% to +10% of nominal voltage		
Protection :	Nema 4		
Power :	120 VAC/60 = Inrush : 10.9 VA (0.09 AMPS) Holding : 7.7VA (0.06 AMPS) DC VOLTS = 1.8 W to 12.7 W		
Response times :	24 VDC (5.4W)	Energize : 6 ms	De-energize : 2 ms
	120 VAC	Energize : 3-8 ms	De-energize : 2-7 ms

- Spare parts :
- Solenoid operator (power ≥ 5.4 W) : DXJ-XFM, including mounting screws 35013.
 - Seal between solenoid and valve body : 16402. • Seal between base and valve : 16453.
 - Valve mounting screw (x2) : 35020. • Blanking plate valve : M-45010. • Blanking plate regulator : M-35005.
- Options :
- BSPP threads. • High flow up to 0.14C_v, according to wattage. • Isolation of inlet and/or exhaust.

DIMENSIONS

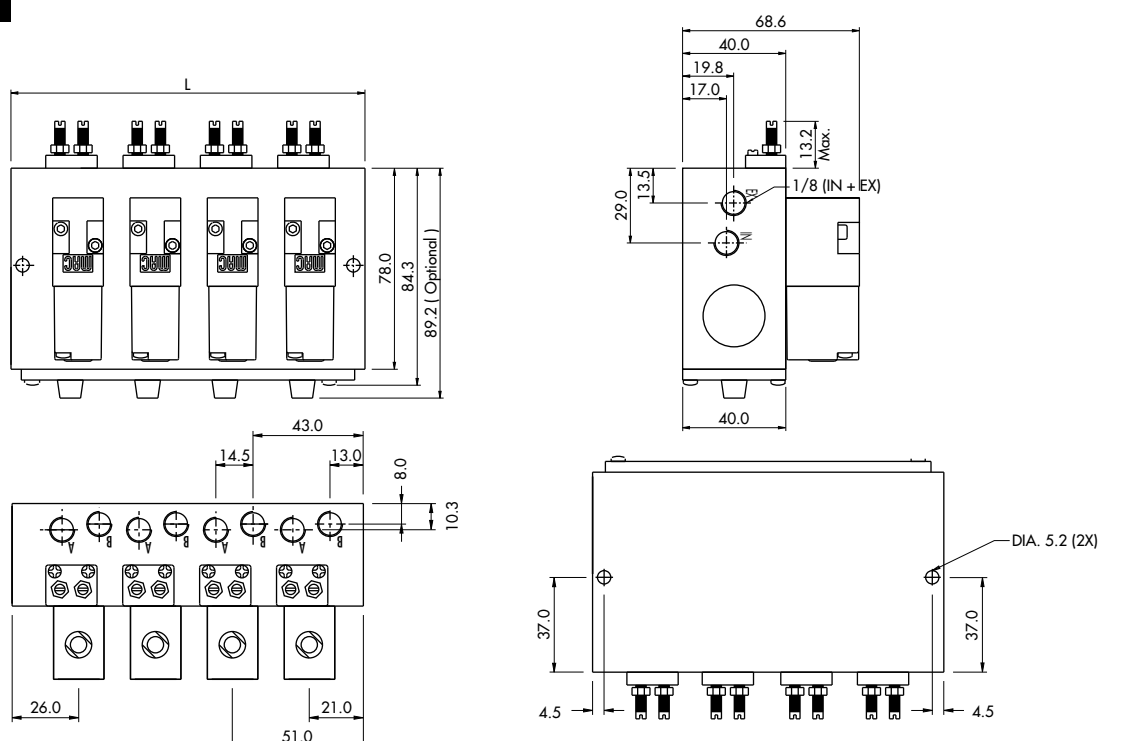

Number of stations	2	3	4	5	6	7	8	9	10
DIM. L	77.0	107.0	137.0	167.0	197.0	227.0	257.0	287.0	317.0

Function	Port size	Flow [Max]	Circuit bar mounting
4/2	1/8" NPTF - #10-32 UNF	0.10C_v	plug-in with Pr. Reg. and F. C.

OPERATIONAL BENEFITS

1. Balanced poppet, immune to variations of pressure.
2. Short stroke with high flow.
3. The patented solenoid develops high shifting forces.
4. Powerful return spring.
5. Manual operator standard on all valves.
6. Burn-out proof solenoid on AC service.

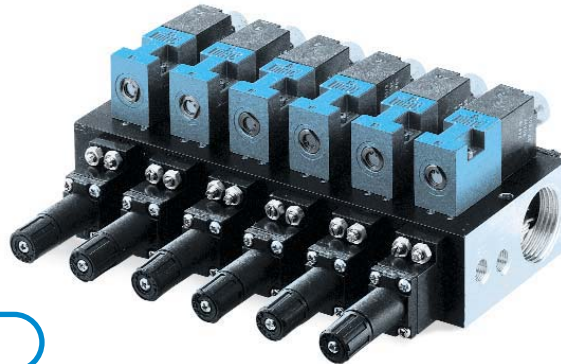

HOW TO ORDER

45A-xxx-DxxJ-xFM

HOW TO ORDER VALVE FOR CIRCUIT BAR MOUNTING "PLUG-IN"

Port size (see base)	Single operator
Valve less base (w/o gage port)	<input type="radio"/> 45A-L00-DxxJ-xFM
Valve less base (w/ gage port)	<input type="radio"/> 45A-M00-DxxJ-xFM



SOLENOID OPERATOR >

D xx J- x FM*

XX Voltage	X Manual operator
<input type="radio"/> AA 120/60, 110/50	<input type="radio"/> 1 Non-locking Recessed
<input type="radio"/> AB 240/60, 220/50	<input type="radio"/> 2 Locking Recessed
<input type="radio"/> AC 24/60, 24/50	<input type="radio"/> x Other Options
<input type="radio"/> FB 24VDC (1.8 W)	
<input type="radio"/> DA 24VDC (5.4 W)	
<input type="radio"/> DF 24VDC (12.7 W)	
<input type="radio"/> xx Other Options	

ECD45A-xxxx-xx-xx

HOW TO ORDER "PLUG-IN" CIRCUIT BAR WITH REGULATORS AND FLOW CONTROLS (TO BE ORDERED SEPARATELY) **

Port size	Spacing mm	Bottom cylinder ports
1/8" NPTF	21	<input type="radio"/> ECD45A-007A-A0-xx
# 10-32 UNF	21	<input type="radio"/> ECD45A-007B-A0-xx
1/8" NPTF	30	<input type="radio"/> ECD45A-037A-C0-xx
# 10-32 UNF	30	<input type="radio"/> ECD45A-037B-C0-xx

Number of stations (03=3 stations)
 Note: clic for valves and regulators mounted to circuit bar at the factory (add - 9 to the model number).
 for multi-pin connector (9, 15 or 25).
 minimum spacing for terminal strips is 30 mm.

Pressure regulators and flow controls:
 45A-001 (Slotted stem)
 45A-002 (Adjusting knob)
 45A-003 (Locking stem)

- A0 = without light
- AA = with light (120V)
- AB = with light (240V)
- AD = with light (24V)
- C0 = terminal strip
- CA = terminal w/light (120V)
- CB = terminal w/light (240V)
- CD = terminal w/light (24V)

**TECHNICAL
DATA**

Fluid :	Compressed air, vacuum, inert gases		
Pressure range :	Vacuum to 120 PSI		
Lubrication :	Not required, if used select a medium aniline point lubricant (between 180°F and 210°F)		
Filtration :	40 µ		
Temperature range :	0°F to 120°F (-18°C to 50°C)		
Orifice :	2 mm		
Flow (at 6 bar, ΔP=1bar) :	1.8 W : 0.08 C _v , 5.4 W : 0.1 C _v		
Coil :	General purpose class A, continuous duty, encapsulated		
Voltage range :	-15% to +10% of nominal voltage		
Protection :	Nema 4		
Power :	120 VAC/60 = Inrush : 10.9 VA (0.09 AMPS) Holding : 7.7VA (0.06 AMPS) DC VOLTS = 1.8 W to 12.7 W		
Response times :	24 VDC (5.4W)	Energize : 6 ms	De-energize : 2 ms
	120 VAC	Energize : 3-8 ms	De-energize : 2-7 ms

Spare parts :

- Solenoid operator (power ≥ 5.4 W) : DXJ-XFM, including mounting screws 35013.
- Seal between solenoid and valve body : 16402. • Seal between base and valve : 16453.
- Valve mounting screw (x2) : 35020. • Blanking plate valve : M-45010. • Blanking plate regulator : M-35005.

Options :

- BSPP threads. • High flow up to 0.14C_v, according to wattage. • Isolation of inlet and/or exhaust.

DIMENSIONS

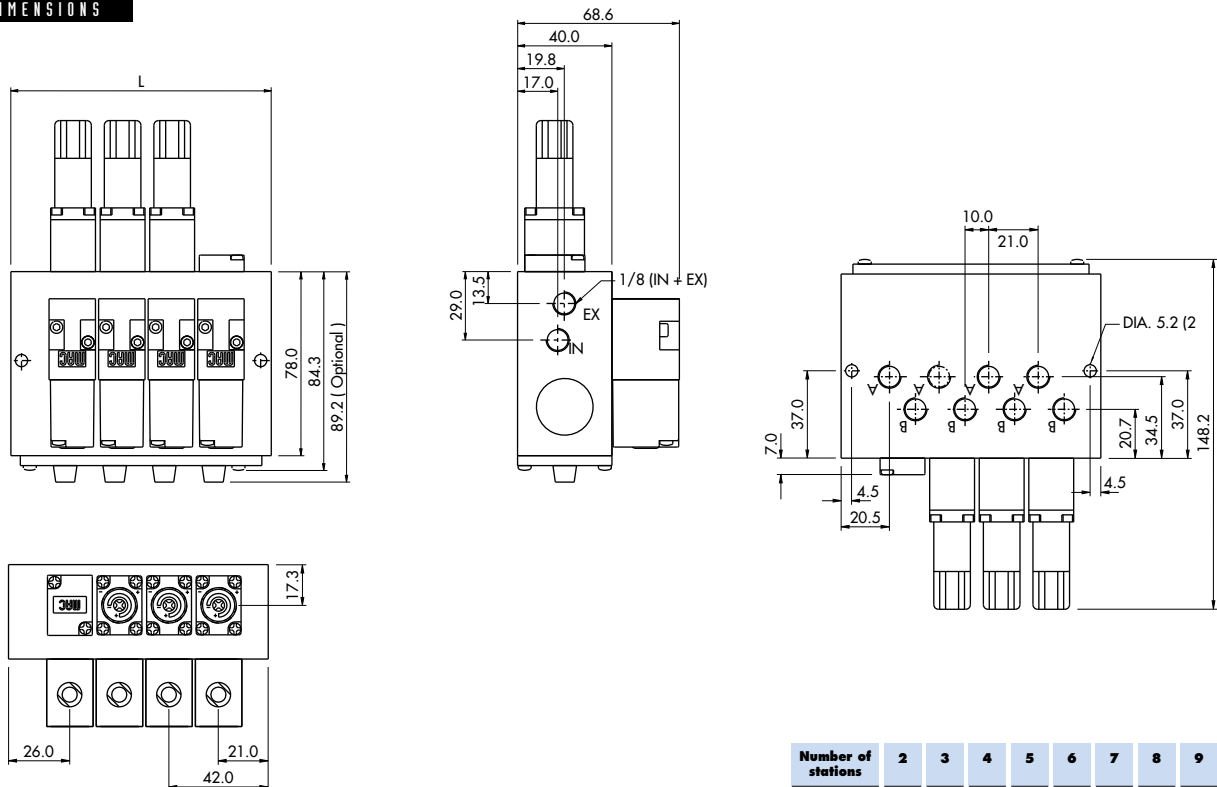

Function	Port size	Flow [Max]	Circuit bar mounting	S
4/2	1/8" NPTF - #10-32 UNF	0.10C _v	plug-in with integral terminal strip	

OPERATIONAL BENEFITS

1. Balanced poppet, immune to variations of pressure.
2. Short stroke with high flow.
3. The patented solenoid develops high shifting forces.
4. Powerful return spring.
5. Manual operator standard on all valves.
6. Burn-out proof solenoid on AC service.



Reset

HOW TO ORDER

45A-LOO-DxxJ-xFM

HOW TO ORDER VALVE FOR CIRCUIT BAR MOUNTING "PLUG-IN"

Single operator

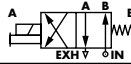

45A-LOO-DxxJ-xFM

Valve less base

SOLENOID OPERATOR

D **xx** J- **x** FM

xx	Voltage
<input type="radio"/> AA	120/60, 110/50
<input type="radio"/> AB	240/60, 220/50
<input type="radio"/> AC	24/60, 24/50
<input type="radio"/> FB	24VDC (1.8 W)
<input type="radio"/> DA	24VDC (5.4 W)
<input type="radio"/> DF	24VDC (12.7 W)
<input type="radio"/> xx	Other Options

x	Manual operator
<input type="radio"/> 1	Non-locking Recessed
<input type="radio"/> 2	Locking Recessed
<input type="radio"/> x	Other Options

HOW TO ORDER "PLUG-IN" CIRCUIT BAR**

ECE45A-011A-CD-02

Port size	Spacing mm	Side cylinder ports	Bottom cylinder ports
1/8" NPTF	26	<input checked="" type="radio"/> ECE45A-011A-C0-xx	<input type="radio"/> ECE45A-012A-C0-xx
# 10-32 UNF	26	<input type="radio"/> ECE45A-011B-C0-xx	<input type="radio"/> ECE45A-012B-C0-xx

Number of stations (03=3 stations)

End plate kit required : M-45017

Note : clic for valves mounted on circuit bar at the factory (add - 9 to the model number).

- C0 = terminal strip
- CA = terminal strip w/light (120V)
- CB = terminal strip w/light (240V)
- CD = terminal strip w/light (24V)

**TECHNICAL
DATA**

Fluid :	Compressed air, vacuum, inert gases
Pressure range :	Vacuum to 120 PSI
Lubrication :	Not required, if used select a medium aniline point lubricant (between 180°F and 210°F)
Filtration :	40 µ
Temperature range :	0°F to 120°F (-18°C to 50°C)
Orifice :	2 mm
Flow (at 6 bar, ΔP=1bar) :	1.8 W : 0.08 C _v , 5.4 W : 0.1 C _v
Coil :	General purpose class A, continuous duty, encapsulated
Voltage range :	-15% to +10% of nominal voltage
Protection :	Nema 4
Power :	120 VAC/60 = Inrush : 10.9 VA (0.09 AMPS) Holding : 7.7VA (0.06 AMPS) DC VOLTS = 1.8 W to 12.7 W
Response times :	24 VDC (5.4W) Energize : 6 ms De-energize : 2 ms 120 VAC Energize : 3-8 ms De-energize : 2-7 ms

Spare parts :

- Solenoid operator (power ≥ 5.4 W) : DXXJ-XFM, including mounting screws 35013.
- Seal between solenoid and valve body : 16402. • Seal between base and valve : 16453.
- Valve mounting screw (x2) : 35020. • Blanking plate valve : M-45010. • Blanking plate regulator : M-35005.

Options :

- BSPP threads. • High flow up to 0.14C_v, according to wattage. • Isolation of inlet and/or exhaust.

DIMENSIONS

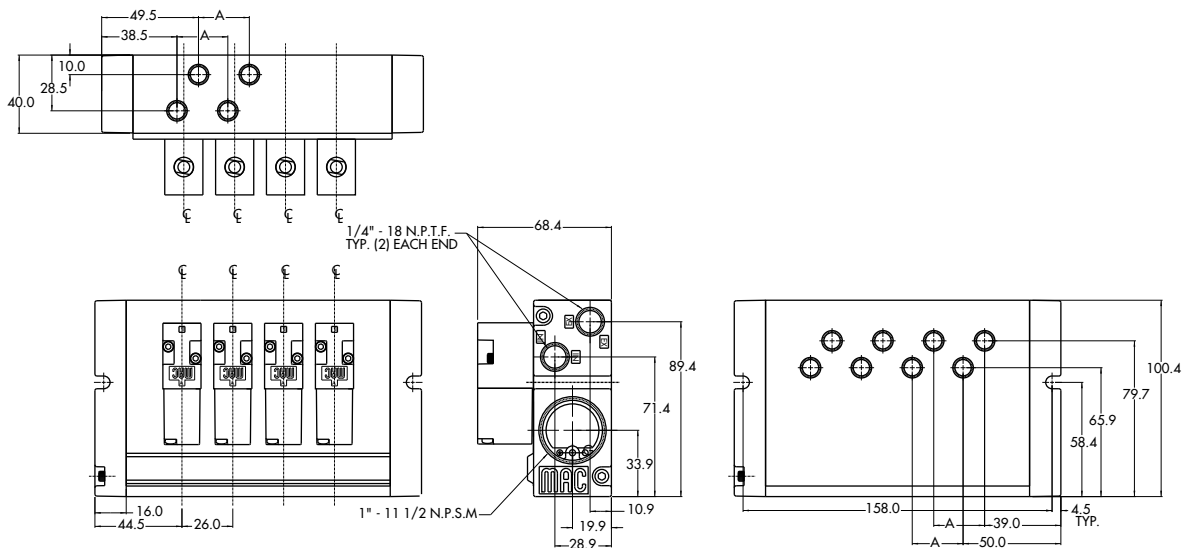

Note: Bottom & side cylinder ports not available on the same station

Function	Port size	Flow [Max]	Circuit bar mounting
4/2	1/8" NPTF - #10-32 UNF	0.10C_v	plug-in with integral terminal strip and side Pr. Reg.

OPERATIONAL BENEFITS

- Balanced poppet, immune to variations of pressure.
- Short stroke with high flow.
- The patented solenoid develops high shifting forces.
- Powerful return spring.
- Manual operator standard on all valves.
- Burn-out proof solenoid on AC service.

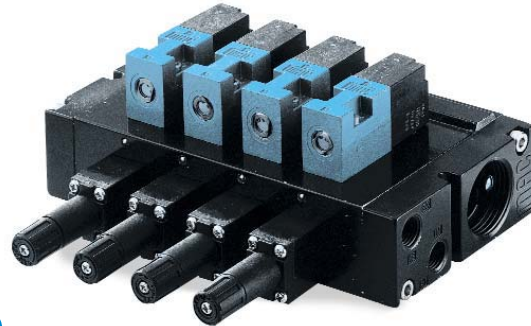

HOW TO ORDER

45A-xxx-DxxJ-xFM

HOW TO ORDER VALVE FOR "PLUG-IN" CIRCUIT BAR

Single operator	
<input type="radio"/> 45A-L00-DxxJ-xFM	Valve less base w/o gage port
<input type="radio"/> 45A-M00-DxxJ-xFM	Valve less base w/ gage port

SOLENOID OPERATOR >

D xx J- x FM

XX Voltage	X Manual operator
<input type="radio"/> AA 120/60, 110/50	<input type="radio"/> 1 Non-locking Recessed
<input type="radio"/> AB 240/60, 220/50	<input type="radio"/> 2 Locking Recessed
<input type="radio"/> AC 24/60, 24/50	<input type="radio"/> x Other Options
<input type="radio"/> FB 24VDC (1.8 W)	
<input type="radio"/> DA 24VDC (5.4 W)	
<input type="radio"/> DF 24VDC (12.7 W)	
<input type="radio"/> xx Other Options	

ECE45A-xxxx-xx-xx

HOW TO ORDER CIRCUIT BAR WITH PRESSURE REGULATORS (TO BE ORDERED SEPARATELY) **

Port size	Spacing mm	Bottom cylinder ports
1/8" NPTF	26	<input type="radio"/> ECE45A-014A-C0-xx
# 10-32 UNF	26	<input type="radio"/> ECE45A-014B-C0-xx
1/8" NPTF	40	<input type="radio"/> ECE45A-024A-C0-xx
# 10-32 UNF	40	<input type="radio"/> ECE45A-024B-C0-xx

Number of stations (03=3 stations)

End plate kit required : M-45017

Note : clic for valves and regulators mounted to circuit bar at the factory (add - 9 to the model number).
Use 40 mm spacing for valves w/ gage port.

** Pressure Regulators :
35A-00M (Adjusting knob)
35A-00L (Slotted stem)
35A-00U (Locking stem)

C0 = terminal strip
 CA = terminal strip w/light (120V)
 CB = terminal strip w/light (240V)
 CD = terminal strip w/light (24V)

**TECHNICAL
DATA**

Fluid :	Compressed air, vacuum, inert gases
Pressure range :	Vacuum to 120 PSI
Lubrication :	Not required, if used select a medium aniline point lubricant (between 180°F and 210°F)
Filtration :	40 µ
Temperature range :	0°F to 120°F (-18°C to 50°C)
Orifice :	2 mm
Flow (at 6 bar, ΔP=1bar) :	1.8 W : 0.08 C _v , 5.4 W : 0.1 C _v
Coil :	General purpose class A, continuous duty, encapsulated
Voltage range :	-15% to +10% of nominal voltage
Protection :	Nema 4
Power :	120 VAC/60 = Inrush : 10.9 VA (0.09 AMPS) Holding : 7.7VA (0.06 AMPS) DC VOLTS = 1.8 W to 12.7 W
Response times :	24 VDC (5.4W) Energize : 6 ms De-energize : 2 ms 120 VAC Energize : 3-8 ms De-energize : 2-7 ms

- Spare parts :
- Solenoid operator (power ≥ 5.4 W) : DXXJ-XFM, including mounting screws 35013.
 - Seal between solenoid and valve body : 16402. • Seal between base and valve : 16453.
 - Valve mounting screw (x2) : 35020. • Blanking plate valve : M-45010. • Blanking plate regulator : M-35005.

- Options :
- BSPP threads. • High flow up to 0.14C_v, according to wattage. • Isolation of inlet and/or exhaust.

DIMENSIONS

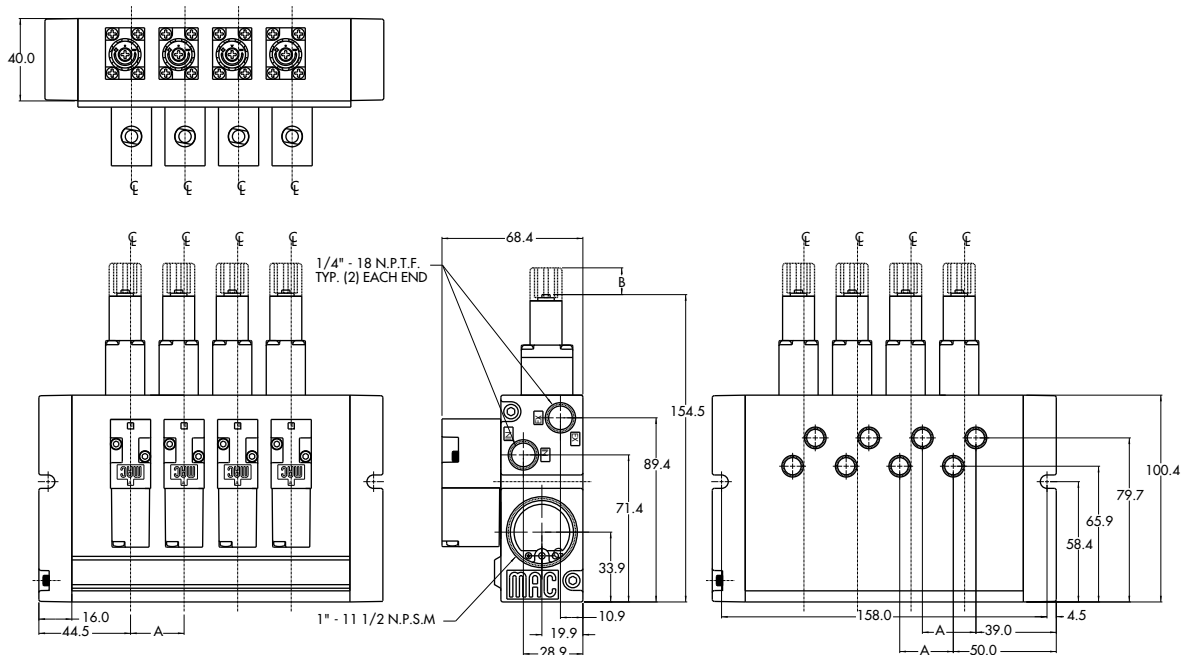

Dim.	B	Dim.	A
SLOTTED LOCKING STEM	6.0	STANDARD SPACING	26.0
ADJUSTING KNOB	13.4	SPACING FOR GAUGES	40.0

Function	Port size	Flow [Max]	Circuit bar mounting
4/2	1/8" NPTF - #10-32 UNF	0.10C_v	plug-in with integral terminal strip and sandwich Pr. Reg.

OPERATIONAL BENEFITS

1. Balanced poppet, immune to variations of pressure.
2. Short stroke with high flow.
3. The patented solenoid develops high shifting forces.
4. Powerful return spring.
5. Manual operator standard on all valves.
6. Burn-out proof solenoid on AC service.



HOW TO ORDER

45A-xxx-DxxJ-xFM

HOW TO ORDER VALVE FOR CIRCUIT BAR MOUNTING "PLUG-IN"

Single operator

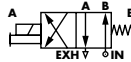

<input type="radio"/> 45A-L00-DxxJ-xFM	Valve w/o gage port
<input type="radio"/> 45A-M00-DxxJ-xFM	Valve w/ gage port

SOLENOID OPERATOR >

D **xx** J- **x** FM

xx Voltage	x Manual operator
<input type="radio"/> AA 120/60, 110/50	<input type="radio"/> 1 Non-locking Recessed
<input type="radio"/> AB 240/60, 220/50	<input type="radio"/> 2 Locking Recessed
<input type="radio"/> AC 24/60, 24/50	<input type="radio"/> x Other Options
<input type="radio"/> FB 24VDC (1.8 W)	
<input type="radio"/> DA 24VDC (5.4 W)	
<input type="radio"/> DF 24VDC (12.7 W)	
<input type="radio"/> xx Other Options	

ECE45A-xxxx-xx-xx

HOW TO ORDER "PLUG-IN" CIRCUIT BAR WITH SANDWICH REGULATORS (TO BE ORDERED SEPARATELY) **

Port size	Spacing mm	Side cylinder ports	Bottom cylinder ports
1/8" NPTF	26	<input type="radio"/> ECE45A-011A-C0-xx	<input type="radio"/> ECE45A-012A-C0-xx
# 10-32 UNF	26	<input type="radio"/> ECE45A-011B-C0-xx	<input type="radio"/> ECE45A-012B-C0-xx
1/8" NPTF	40	<input type="radio"/> ECE45A-021A-C0-xx	<input type="radio"/> ECE45A-022A-C0-xx
# 10-32 UNF	40	<input type="radio"/> ECE45A-021B-C0-xx	<input type="radio"/> ECE45A-022B-C0-xx

Number of stations (03=3 stations)
 End plate kit required : M-45017
 Note : clic for valves and regulators mounted to circuit bar at the factory (add - 9 to the model number).
 Use 40 mm spacing for valves w/ gage port.

** Pressure Regulators :
 PR45A-AA0A (Adjusting knob)
 PR45A-AB0A (Slotted stem)
 PR45A-AC0A (Locking stem)

C0 = terminal strip
 CA = terminal strip w/light (120V)
 CB = terminal strip w/light (240V)
 CD = terminal strip w/light (24V)

**TECHNICAL
DATA**

Fluid :	Compressed air, vacuum, inert gases
Pressure range :	Vacuum to 120 PSI
Lubrication :	Not required, if used select a medium aniline point lubricant (between 180°F and 210°F)
Filtration :	40 µ
Temperature range :	0°F to 120°F (-18°C to 50°C)
Orifice :	2 mm
Flow (at 6 bar, ΔP=1bar) :	1.8 W : 0.08 C _v , 5.4 W : 0.1 C _v
Coil :	General purpose class A, continuous duty, encapsulated
Voltage range :	-15% to +10% of nominal voltage
Protection :	Nema 4
Power :	120 VAC/60 = Inrush : 10.9 VA (0.09 AMPS) Holding : 7.7VA (0.06 AMPS) DC VOLTS = 1.8 W to 12.7 W
Response times :	24 VDC (5.4W) Energize : 6 ms De-energize : 2 ms 120 VAC Energize : 3-8 ms De-energize : 2-7 ms

Spare parts :

- Solenoid operator (power ≥ 5.4 W) : DXXJ-XFM, including mounting screws 35013.
- Seal between solenoid and valve body : 16402. • Seal between base and valve : 16453.
- Valve mounting screw (x2) : 35020. • Blanking plate valve : M-45010. • Blanking plate regulator : M-35005.

Options :

- BSPP threads. • High flow up to 0.14C_v, according to wattage. • Isolation of inlet and/or exhaust.

DIMENSIONS

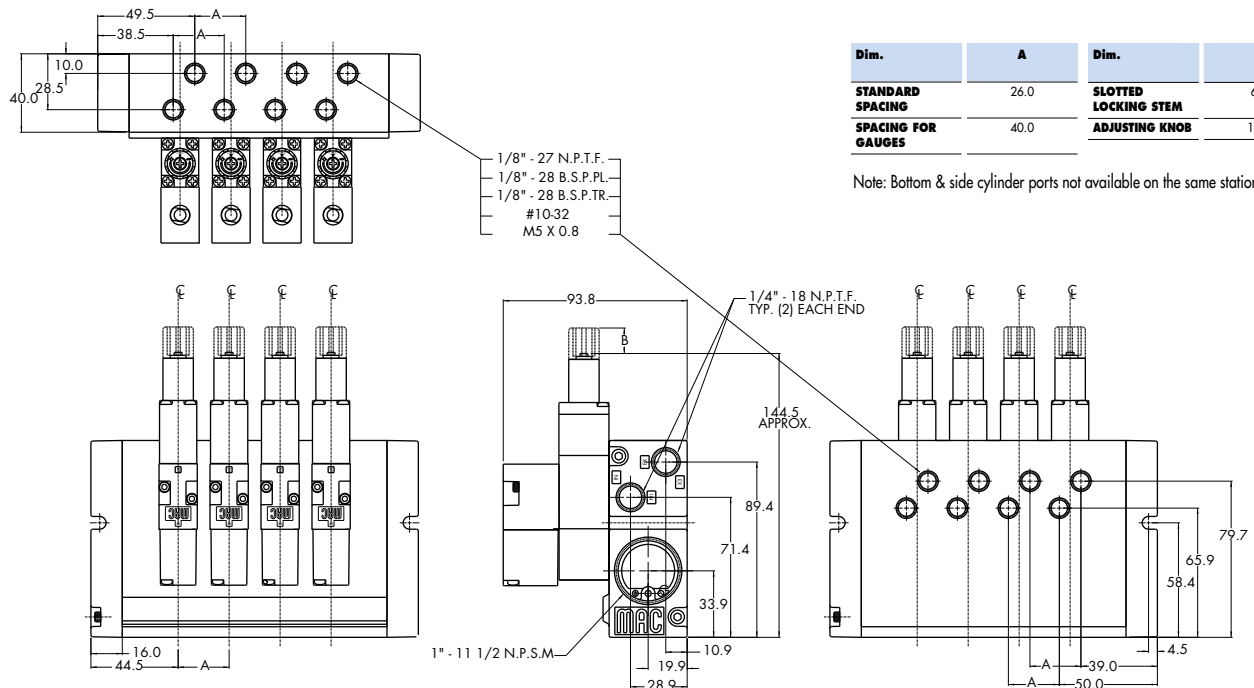

Function	Port size	Flow [Max]	Circuit bar mounting
4/2	1/8" NPTF - #10-32 UNF	0.10C_v	plug-in with integral terminal strip with F. C.

OPERATIONAL BENEFITS

1. Balanced poppet, immune to variations of pressure.
2. Short stroke with high flow.
3. The patented solenoid develops high shifting forces.
4. Powerful return spring.
5. Manual operator standard on all valves.
6. Burn-out proof solenoid on AC service.

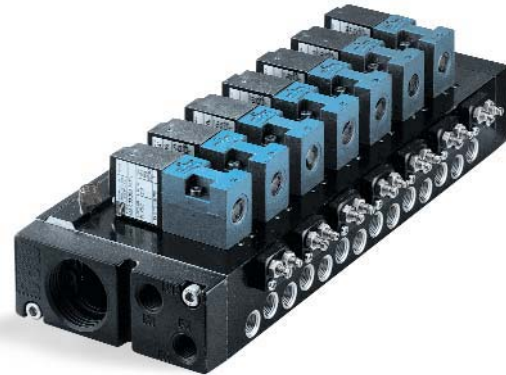

HOW TO ORDER

45A-xxx-DxxJ-xFM

HOW TO ORDER VALVE FOR CIRCUIT BAR MOUNTING "PLUG-IN"

Single operator

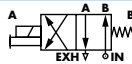

45A-L00-DxxxJ-xFM

Valve less base

SOLENOID OPERATOR

D xx J- x FM

XX	Voltage
<input type="radio"/> AA	120/60, 110/50
<input type="radio"/> AB	240/60, 220/50
<input type="radio"/> AC	24/60, 24/50
<input type="radio"/> FB	24VDC (1.8 W)
<input type="radio"/> DA	24VDC (5.4 W)
<input type="radio"/> DF	24VDC (12.7 W)
<input type="radio"/> xx	Other Options

X	Manual operator
<input type="radio"/> 1	Non-locking Recessed
<input type="radio"/> 2	Locking Recessed
<input type="radio"/> x	Other Options

HOW TO ORDER "PLUG-IN" CIRCUIT BAR WITH FLOW CONTROLS **

ECE45A-xxxx-xx-xx

Port size	Spacing mm	Side cylinder ports	Bottom cylinder ports
1/8" NPTF	26	-----	<input type="radio"/> ECE45A-016A-C0-xx
# 10-32 UNF	26	-----	<input type="radio"/> ECE45A-016B-C0-xx
1/8" NPTF	30	<input type="radio"/> ECE45A-035A-C0-xx	-----
# 10-32 UNF	30	<input type="radio"/> ECE45A-035B-C0-xx	-----

Number of stations (03=3 stations)

End plate kit required : M-45017

Note : clic for valves and regulators mounted to circuit bar at the factory (add - 9 to the model number).

- C0 = terminal strip
- CA = terminal strip w/light (120V)
- CB = terminal strip w/light (240V)
- CD = terminal strip w/light (24V)

TECHNICAL DATA

Fluid :	Compressed air, vacuum, inert gases
Pressure range :	Vacuum to 120 PSI
Lubrication :	Not required, if used select a medium aniline point lubricant (between 180°F and 210°F)
Filtration :	40 μ
Temperature range :	0°F to 120°F (-18°C to 50°C)
Orifice :	2 mm
Flow (at 6 bar, ΔP=1bar) :	1.8 W : 0.08 C _v , 5.4 W : 0.1 C _v
Coil :	General purpose class A, continuous duty, encapsulated
Voltage range :	-15% to +10% of nominal voltage
Protection :	Nema 4
Power :	120 VAC/60 = Inrush : 10.9 VA (0.09 AMPS) Holding : 7.7VA (0.06 AMPS) DC VOLTS = 1.8 W to 12.7 W
Response times :	24 VDC (5.4W) Energize : 6 ms De-energize : 2 ms 120 VAC Energize : 3-8 ms De-energize : 2-7 ms

- Spare parts :
- Solenoid operator (power ≥ 5.4 W) : DXXJ-XFM, including mounting screws 35013.
 - Seal between solenoid and valve body : 16402. • Seal between base and valve : 16453.
 - Valve mounting screw (x2) : 35020. • Blanking plate valve : M-45010. • Blanking plate regulator : M-35005.

- Options :
- BSPP threads. • High flow up to 0.14C_v, according to wattage. • Isolation of inlet and/or exhaust.

DIMENSIONS

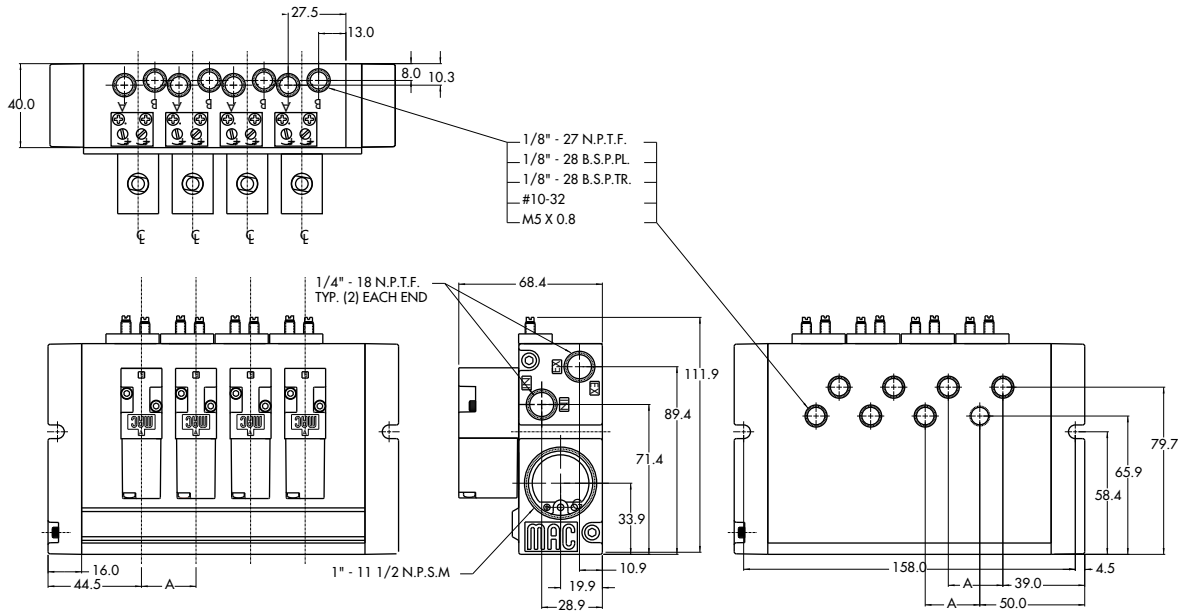

Dim.	A
STANDARD SPACING	26.0
OPTIONAL SPACING	30.0

Note: Bottom & side cylinder ports not available on the same station

Consult "Precautions" before use, installation or service of MAC Valves.

Function	Port size	Flow [Max]	Circuit bar mounting
4/2	1/8" NPTF - #10-32 UNF	0.10C_v	plug-in with integral terminal strip with Pr. Reg. and F. C.

OPERATIONAL BENEFITS

1. Balanced poppet, immune to variations of pressure.
2. Short stroke with high flow.
3. The patented solenoid develops high shifting forces.
4. Powerful return spring.
5. Manual operator standard on all valves.
6. Burn-out proof solenoid on AC service.

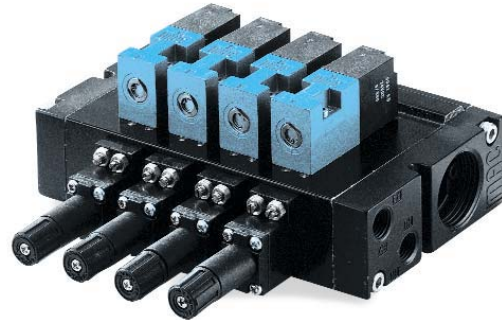

HOW TO ORDER

45A-xxx-DxxJ-xFM

HOW TO ORDER VALVE FOR CIRCUIT BAR MOUNTING "PLUG-IN"

Single operator	
<input type="radio"/> 45A-L00-DxxJ-xFM	Valve less base
<input type="radio"/> 45A-M00-DxxJ-xFM	Valve less base w/ gage port

SOLENOID OPERATOR >

D **xx** J- **x** FM

xx Voltage	x Manual operator
<input type="radio"/> AA 120/60, 110/50	<input type="radio"/> 1 Non-locking Recessed
<input type="radio"/> AB 240/60, 220/50	<input type="radio"/> 2 Locking Recessed
<input type="radio"/> AC 24/60, 24/50	<input type="radio"/> x Other Options
<input type="radio"/> FB 24VDC (1.8 W)	
<input type="radio"/> DA 24VDC (5.4 W)	
<input type="radio"/> DF 24VDC (12.7 W)	
<input type="radio"/> xx Other Options	

ECE45A-xxxx-xx-xx

HOW TO ORDER "PLUG-IN" CIRCUIT BAR WITH PRESSURE AND FLOW CONTROLS (TO BE ORDERED SEPARATELY) **

Port size	Spacing mm	Bottom cylinder ports
1/8" NPTF	26	<input type="radio"/> ECE45A-017A-C0-xx
# 10-32 UNF	26	<input type="radio"/> ECE45A-017B-C0-xx
1/8" NPTF	40	<input type="radio"/> ECE45A-027A-C0-xx
# 10-32 UNF	40	<input type="radio"/> ECE45A-027B-C0-xx

Number of stations (03=3 stations)
 End plate kit required : M-45017
 Note : clic for valves and regulators mounted to circuit bar at the factory (add - 9 to the model number).
 Use 40 mm spacing for valves w/ gage port.

** Pressure Regulators :
 45A-001 (Slotted stem)
 45A-002 (Adjusting knob)
 45A-003 (Locking stem)

C0 = terminal strip
 CA = terminal strip w/light (120V)
 CB = terminal strip w/light (240V)
 CD = terminal strip w/light (24V)

TECHNICAL DATA

Fluid :	Compressed air, vacuum, inert gases		
Pressure range :	Vacuum to 120 PSI		
Lubrication :	Not required, if used select a medium aniline point lubricant (between 180°F and 210°F)		
Filtration :	40 µ		
Temperature range :	0°F to 120°F (-18°C to 50°C)		
Orifice :	2 mm		
Flow (at 6 bar, ΔP=1bar) :	1.8 W : 0.08 C _v , 5.4 W : 0.1 C _v		
Coil :	General purpose class A, continuous duty, encapsulated		
Voltage range :	-15% to +10% of nominal voltage		
Protection :	Nema 4		
Power :	120 VAC/60 = Inrush : 10.9 VA (0.09 AMPS) Holding : 7.7VA (0.06 AMPS) DC VOLTS = 1.8 W to 12.7 W		
Response times :	24 VDC (5.4W)	Energize : 6 ms	De-energize : 2 ms
	120 VAC	Energize : 3-8 ms	De-energize : 2-7 ms

Spare parts :
 • Solenoid operator (power ≥ 5.4 W) : DXXJ-XFM, including mounting screws 35013.
 • Seal between solenoid and valve body : 16402. • Seal between base and valve : 16453.
 • Valve mounting screw (x2) : 35020. • Blanking plate valve : M-45010. • Blanking plate regulator : M-35005.

Options :
 • BSPP threads. • High flow up to 0.14C_v, according to wattage. • Isolation of inlet and/or exhaust.

DIMENSIONS

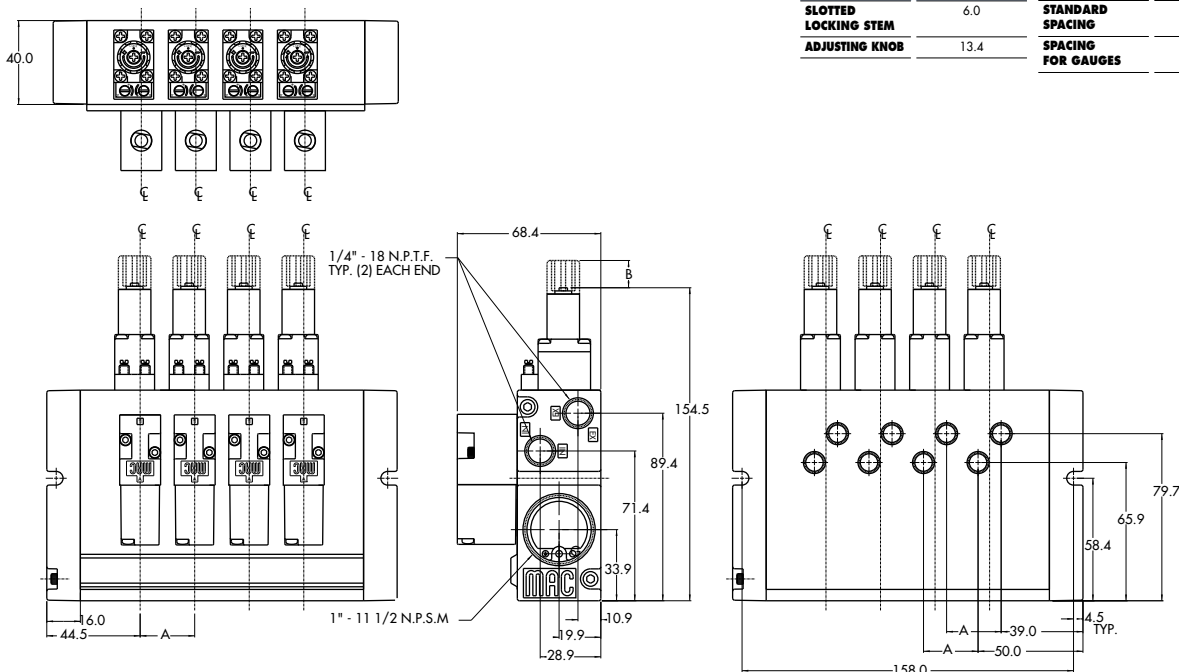



Section 2

Options



0 p t i o n s

Codification table for voltages / Wire length / Manual operators / Electrical connections

VALVE CODE ➤

-DXX X - X XX
1 2 3 4

OPTIONS AVAILABLE FOR

- Solenoid valves 35 & 45 Series

1. VOLTAGE

- D XX	X - X XX	VOLTAGE
<input type="radio"/>	AD	24/60
<input type="radio"/>	AE	200/60
<input type="radio"/>	AF	240/50
<input type="radio"/>	AG	100/50, 100/60, 110/60
<input type="radio"/>	DB	12 VDC (5.4 W)
<input type="radio"/>	DC	12 VDC (7.5 W)
<input type="radio"/>	DD	24 VDC (7.3 W)
<input type="radio"/>	DE	12 VDC (12.7 W) CLSF
<input type="radio"/>	DK	110 VDC (5.8 W)
<input type="radio"/>	DL	64 VDC (6.0 W)
<input type="radio"/>	DM	36 VDC (5.8 W)
<input type="radio"/>	DN	6 VDC (6.0 W)
<input type="radio"/>	DP	48 VDC (5.8 W)
<input type="radio"/>	DU	24 VDC (6.0 W)
<input type="radio"/>	EA	12 VDC (6.0 W)
<input type="radio"/>	FA	12 VDC (1.8 W)
<input type="radio"/>	FE	12 VDC (2.4 W)
<input type="radio"/>	FF	24 VDC (2.4 W)

2. WIRE LENGTH

- D XX	X - X XX	WIRE LENGTH
<input type="radio"/>	B	24"
<input type="radio"/>	C	36"
<input type="radio"/>	D	48"
<input type="radio"/>	E	72"
<input type="radio"/>	F	96"



3. MANUAL OPERATOR

- D XX X - X XX	MANUAL OPERATOR	
<input type="radio"/> 0	0	No operator
<input type="radio"/> 1	1	Non-locking recessed
<input type="radio"/> 2	2	Locking recessed
<input type="radio"/> 3	3	Non-locking extended
<input type="radio"/> 4	4	Locking extended

4. ELECTRICAL CONNECTION

- D XX X - X XX	ELECTRICAL CONNECTION	
<input type="radio"/> BA	BA	Flying leads
<input type="radio"/> BK	BK	BA with protection diode
<input type="radio"/> BL	BL	BA with protection varistor
<input type="radio"/> CA	CA	1/2" NPS conduit
<input type="radio"/> *FN	*FN	Plug-in with diode
<input type="radio"/> *FP	*FP	Plug-in with M.O.V.
<input type="radio"/> JB	JB	Rectangular connector
<input type="radio"/> JD	JD	Rectangular connector with light
<input type="radio"/> JM	JM	Rectangular connector, male only
<input type="radio"/> KA	KA	Square connector
<input type="radio"/> KB	KB	Square connector with protection diode
<input type="radio"/> KC	KC	Square connector with protection varistor
<input type="radio"/> KD	KD	Square connector with light
<input type="radio"/> KE	KE	Square connector with light and protection diode
<input type="radio"/> KF	KF	Square connector with light and protection varistor
<input type="radio"/> KJ	KJ	Square connector (male only)
<input type="radio"/> KK	KK	Square connector with protection diode (male only)
<input type="radio"/> KL	KL	Square connector with protection varistor (male only)
<input type="radio"/> TA	TA	Dual tabs
<input type="radio"/> TB	TB	TA with protection diode
<input type="radio"/> TD	TD	TA with light
<input type="radio"/> TE	TE	TA with light and protection diode
<input type="radio"/> TJ	TJ	Dual tabs (male only)
<input type="radio"/> TK	TK	TJ with protection diode
<input type="radio"/> TM	TM	TJ with light
<input type="radio"/> TN	TN	TJ with light and protection diode

* For use with the ECD and ECE style circuit bars.

MOD. S009

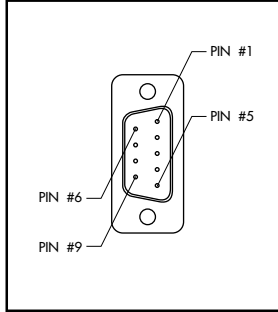

TECHNICAL DATA

- Type «SUB_D»
- Number of contacts : 9
- Solder termination (Dia. 0.6 mm/0.14 mm²/26-22 AWG)
- Operating current 5 A/contact
- Rated voltage 125 V~
- Temp. range -40° to +125°C
- Insulation resistance ≥ 5.0⁹ Ω
- Protection class IP40 (DIN 40050)
- Number of solenoids : 7 max.
- Max. 24 V=/5.4 W per solenoid
- 2 common wires

MOD. S015

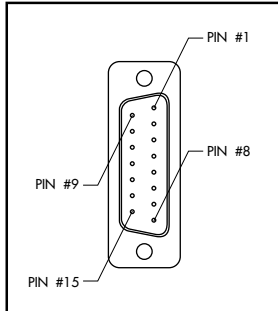

TECHNICAL DATA

- Type «SUB_D»
- Number of contacts : 15
- Solder termination (Dia. 0.6 mm/0.14 mm²/26-22 AWG)
- Operating current 5 A/contact
- Rated voltage 125 V~
- Temp. range -40° to +125°C
- Insulation resistance ≥ 5.0⁹ Ω
- Protection class IP40 (DIN 40050)
- Number of solenoids : 12 max.
- Max. 24 V=/5.4 W per solenoid
- 3 common wires

MOD. S025

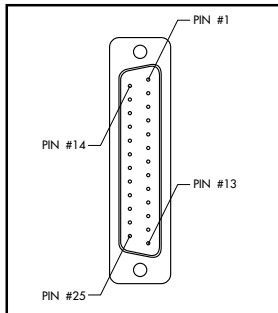

TECHNICAL DATA

- Type «SUB_D»
- Number of contacts : 25
- Solder termination (Dia. 0.6 mm/0.14 mm²/26-22 AWG)
- Operating current 5 A/contact
- Rated voltage 125 V~
- Temp. range -40° to +125°C
- Insulation resistance ≥ 5.0⁹ Ω
- Protection class IP40 (DIN 40050)
- Number of solenoids : 20 max.
- Max. 24 V=/5.4 W per solenoid
- 5 common wires

Note : Use desired MOD. number after circuit bar part number

Connector termination details

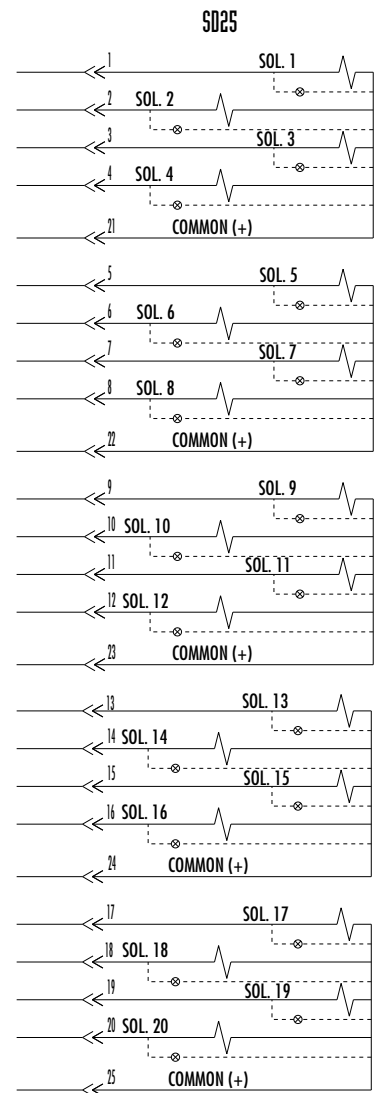
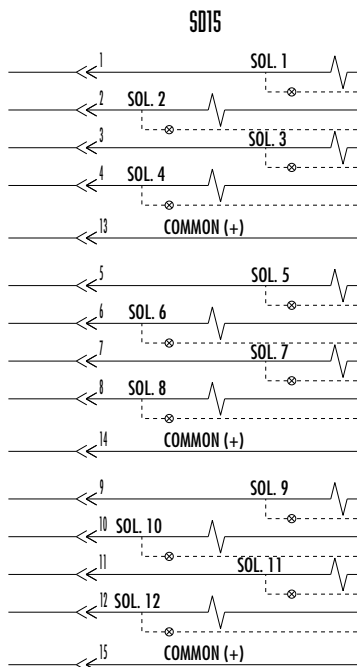
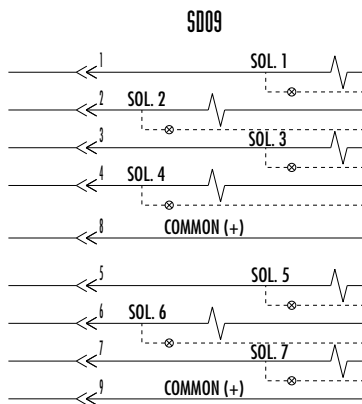
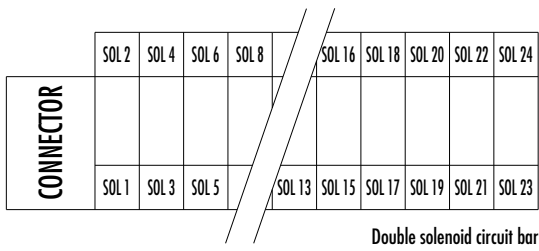
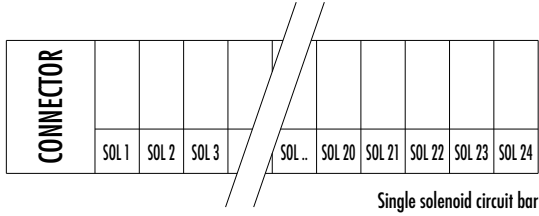

Circuit bar mounting

non plug-in cyl. ports in valve with opt. F. C.	non plug-in cyl. ports in base with opt. F. C.	add-on style non plug-in cyl. ports in valve with opt. F. C.	add-on style non plug-in cyl. ports in base with opt. F. C.	non plug-in cyl. ports in valve with opt. Pr. Reg.	non plug-in cyl. ports in base	non plug-in cyl. ports in base with Pr. Reg.	add-on style non plug-in cyl. ports in base
add-on style non plug-in cyl. ports in base with Pr. Reg.	plug-in	plug-in with Pr. Reg.	add-on style plug-in	add-on style plug-in with Pr. Reg.	plug-in add-a-unit stations	plug-in add-a-unit stations with Pr. Reg.	

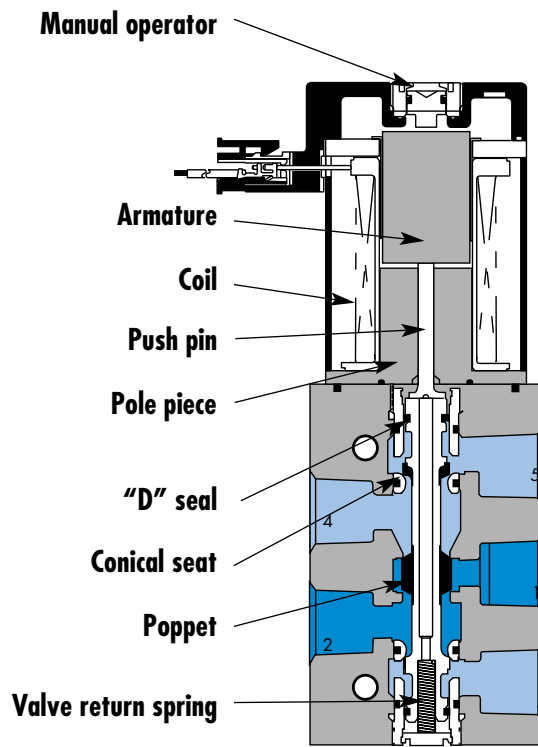

SERIES FEATURES

- Short stroke solenoid produces high energization shifting force.
- High force return spring due to high force solenoid maximizes both energization and de-energization shifting forces.
- Built-in wear compensation - valve stroke is shorter than solenoid stroke.
- Four (4) bonded balanced poppets on a one-piece valve stem.
- End poppets seal first on conical seats and cushion inlet poppet, eliminating cutting.
- Exhaust seals are not under inlet pressure thus reducing friction.
- Short stroking balanced poppet allows for direct solenoid operation with high shifting forces, minimized friction, fast response and high flow in a small package.



Direct solenoid and solenoid pilot operated valves

Function	Port size (Inlet & Exhaust)	Flow (Max)	Circuit bar mounting	Profile
5/2	3/8"	0.5C_v	non plug-in cyl. ports in valve with opt. F. C.	29 mm

OPERATIONAL BENEFITS

1. Direct solenoid operated valve.
2. Balanced poppet, immune to variations of pressure.
3. Short stroke with high flow.
4. The patented solenoid develops high shifting forces.
5. Powerful return spring.
6. Manual operator standard on all valves.

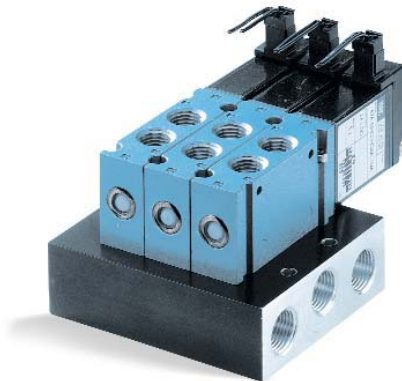

HOW TO ORDER

47A-xxx-Hxxx-xxx

HOW TO ORDER VALVE FOR CIRCUIT BAR MOUNTING

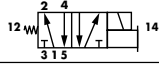
Valve port size	Valve less base
1/8" NPTF	 <input type="radio"/> 47A-MG0-Hxxx-xxx
1/4" NPTF	<input type="radio"/> 47A-MH0-Hxxx-xxx

SOLENOID OPERATOR >

H **XX X- X XX'**

XX Voltage	X Wire length	X Manual operator	XX Electrical connection
<input type="radio"/> DA 24VDC (5.2 W)	<input type="radio"/> A 18"	<input type="radio"/> 1 Non-locking	<input type="radio"/> BA Flying leads
<input type="radio"/> DB 24VDC (2.4 W)	<input type="radio"/> C 36"		<input type="radio"/> BC Flying leads with light
<input type="radio"/> DC 24VDC (1.8 W)	<input type="radio"/> x Other Options		<input type="radio"/> MA Plug-in wire assy
<input type="radio"/> DD 24VDC (1.0 W)			<input type="radio"/> MC Plug-in wire assy with light
<input type="radio"/> AA 120VAC (must use with rectified connector)			<input type="radio"/> HA Plug-in connector with rectifier and light
<input type="radio"/> xx Other Options			<input type="radio"/> xx Other Options

EBM47A-xxxxx-xx

HOW TO ORDER CIRCUIT BAR

Port size COMMON INLET & EXHAUST	Without flow controls (20 mm)	With flow controls (20 mm)
3/8" NPTF	<input type="radio"/> EBM47A-01CAK-xx	<input type="radio"/> EBM47A-01DAK-xx

Number of stations (03=3 stations)

Note: clic for valves mounted on base at the factory (add - 9 to the model number).

**TECHNICAL
DATA**

Fluid :	Compressed air, vacuum, inert gases
Pressure range :	Vacuum to 120 PSI
Lubrication :	Not required, if used select a medium aniline point lubricant (between 180°F and 210°F)
Filtration :	40 µ
Temperature range :	0°F to 120°F (-18°C to 50°C)
Orifice :	4.3 mm
Flow (at 6 bar, ΔP=1bar) :	5.2 W : 0.50C _v , 2.4 W : 0.30C _v , 1.8 W : 0.25C _v , 1.0 W : 0.25C _v
Coil :	General purpose class A, continuous duty, encapsulated
Voltage range :	-15% to +10% of nominal voltage
Power :	5.2 W - 2.4 W - 1.8 W - 1.0 W
Response times :	Energize : 14.0 ms
(with 5.2 W coil)	De-energize : 5.0 ms

Note :

- Valve and coil are not interchangeable.

Spare parts :

- Seal between valve and bar : 16629. • Mounting screw (x2) : 35043. • Valve blanking plate : M-47002. • Flow control kit (x2) : N-37001.

Options :

- Isolation of inlet and/or exhaust. Special bar. Consult factory. • BSPP Threads.

DIMENSIONS

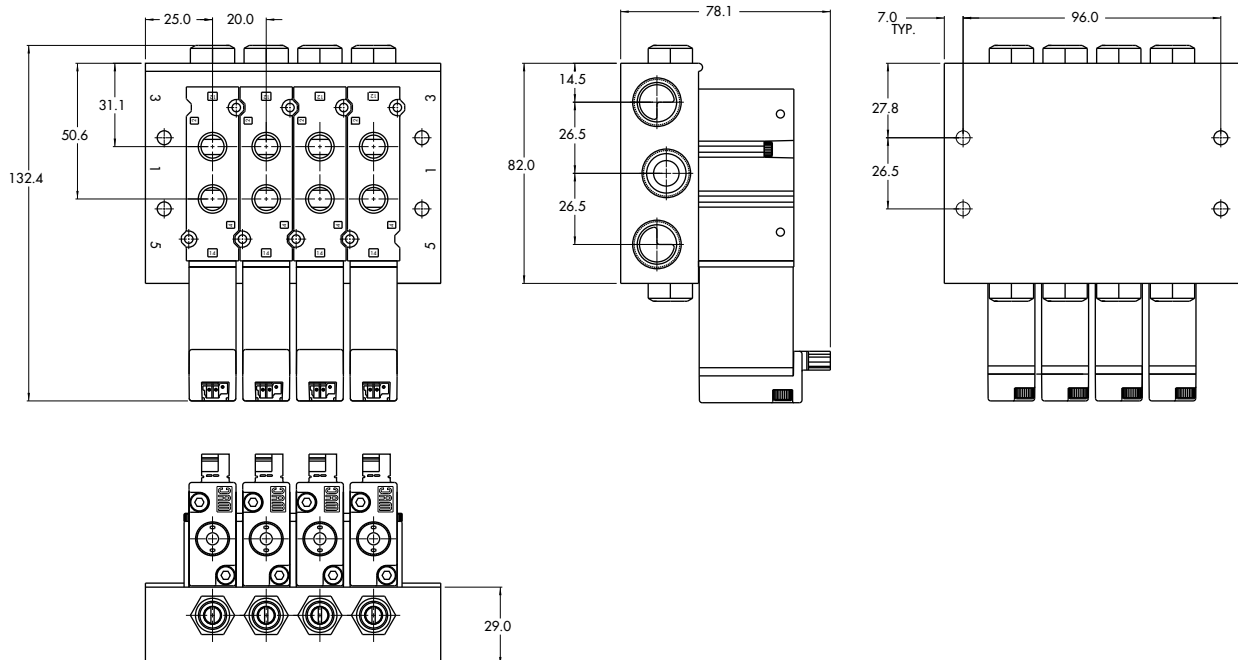

Function	Port size	Flow [Max]	Circuit bar mounting	Profile
5/2	1/8" - 1/4" 6 mm tube receptacle	0.5C_v	non plug-in cyl. ports in base with opt. F. C.	29 mm

OPERATIONAL BENEFITS

1. Direct solenoid operated valve.
2. Balanced poppet, immune to variations of pressure.
3. Short stroke with high flow.
4. The patented solenoid develops high shifting forces.
5. Powerful return spring.
6. Manual operator standard on all valves.

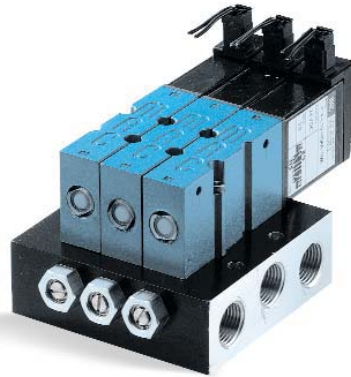

HOW TO ORDER

47A-xxx-Hxxx-xxx

HOW TO ORDER VALVE FOR CIRCUIT BAR MOUNTING

Port size (see base)	Valve
Valve less base	 <input type="radio"/> 47A-LI0-Hxxx-xxx

SOLENOID OPERATOR >

H **XX X- X XX'**

XX Voltage	X Wire length	X Manual operator	XX Electrical connection
<input type="radio"/> DA 24VDC (5.2 W)	<input type="radio"/> A 18"	<input type="radio"/> I Non-locking	<input type="radio"/> BA Flying leads
<input type="radio"/> DB 24VDC (2.4 W)	<input type="radio"/> C 36"		<input type="radio"/> BC Flying leads with light
<input type="radio"/> DC 24VDC (1.8 W)	<input type="radio"/> x Other Options		<input type="radio"/> MA Plug-in wire assy
<input type="radio"/> DD 24VDC (1.0 W)			<input type="radio"/> MC Plug-in wire assy with light
<input type="radio"/> AA 120VAC (must use with rectified connector)			<input type="radio"/> HA Plug-in connector with rectifier and light
<input type="radio"/> xx Other Options			<input type="radio"/> xx Other Options

EBM47A-xxxxx-xx

HOW TO ORDER CIRCUIT BAR

Port size	Bottom cylinder ports (18 mm)	Bottom cylinder ports with flow controls (18 mm)
1/8" NPTF	<input type="radio"/> EBM47A-00AAA-xx	<input type="radio"/> EBM47A-00BAA-xx
1/4" NPTF	<input type="radio"/> EBM47A-00AAB-xx	<input type="radio"/> EBM47A-00BAB-xx
6 mm tube receptacle	<input type="radio"/> EBM47A-00AAG-xx	<input type="radio"/> EBM47A-00BAG-xx

Number of stations (03=3 stations)

Note: clic for valves mounted on base at the factory (add - 9 to the model number).

**TECHNICAL
D A T A**

Fluid :	Compressed air, vacuum, inert gases
Pressure range :	Vacuum to 120 PSI
Lubrication :	Not required, if used select a medium aniline point lubricant (between 180°F and 210°F)
Filtration :	40 µ
Temperature range :	0°F to 120°F (-18°C to 50°C)
Orifice :	4.3 mm
Flow (at 6 bar, ΔP=1bar) :	5.2 W : 0.50C _v , 2.4 W : 0.30C _v , 1.8 W : 0.25C _v , 1.0 W : 0.25C _v
Coil :	General purpose class A, continuous duty, encapsulated
Voltage range :	-15% to +10% of nominal voltage
Power :	5.2 W - 2.4 W - 1.8 W - 1.0 W
Response times :	Energize : 14.0 ms
(with 5.2 W coil)	De-energize : 5.0 ms

- Note :
 - Valve and coil are not interchangeable.
- Spare parts :
 - Seal between valve and bar : 16629. • Mounting screw (x2) : 35043. • Valve blanking plate : M-47001.
 - Flow control kit (x2) : N-37001.
- Options :
 - Isolation of inlet and/or exhaust. Special bar. Consult factory. • BSPP Threads.

D I M E N S I O N S

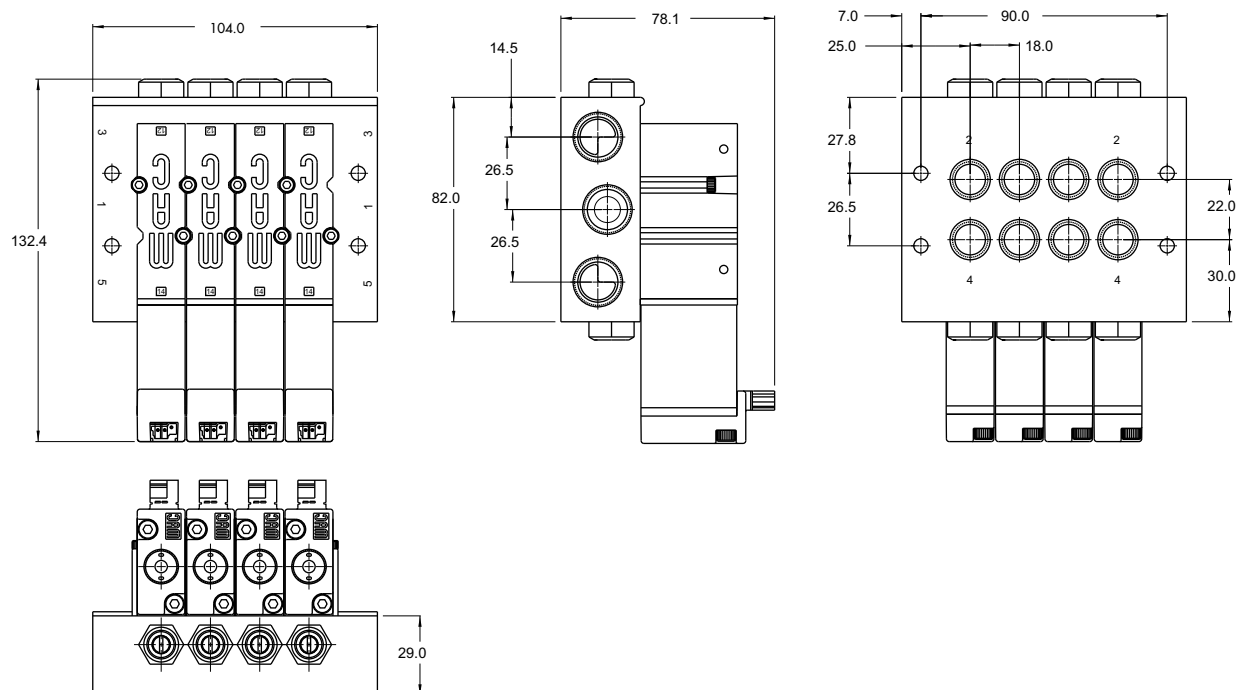



Direct solenoid and solenoid pilot operated valves

Function	Port size (Inlet & Exhaust)	Flow (Max)	Circuit bar mounting	Profile
5/2	3/8"	0.5C_v	add-on style non plug-in cyl. ports in valve with opt. F. C.	35 mm

OPERATIONAL BENEFITS

1. Direct solenoid operated valve.
2. Balanced poppet, immune to variations of pressure.
3. Short stroke with high flow.
4. The patented solenoid develops high shifting forces.
5. Powerful return spring.
6. Manual operator standard on all valves.



HOW TO ORDER

47A-xxx-Hxxx-xxx

HOW TO ORDER VALVE FOR CIRCUIT BAR MOUNTING

Valve port size	Valve
1/8" NPTF	<input type="radio"/> 47A-MG0-Hxxx-xxx
1/4" NPTF	<input type="radio"/> 47A-MH0-Hxxx-xxx

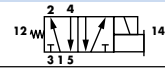

SOLENOID OPERATOR >

H **XX X- X XX'**

XX Voltage	X Wire length	X Manual operator	XX Electrical connection
<input type="radio"/> DA 24VDC (5.2 W)	<input type="radio"/> A 18"	<input type="radio"/> l Non-locking	<input type="radio"/> BA Flying leads
<input type="radio"/> DB 24VDC (2.4 W)	<input type="radio"/> c 36"		<input type="radio"/> BC Flying leads with light
<input type="radio"/> DC 24VDC (1.8 W)	<input type="radio"/> x Other Options		<input type="radio"/> MA Plug-in wire assy
<input type="radio"/> DD 24VDC (1.0 W)			<input type="radio"/> MC Plug-in wire assy with light
<input type="radio"/> AA 120VAC (must use with rectified connector)			<input type="radio"/> HA Plug-in connector with rectifier and light
<input type="radio"/> xx Other Options			<input type="radio"/> xx Other Options

EBM47A-xxxxx-xx

HOW TO ORDER CIRCUIT BAR

Port size COMMON INLET & EXHAUST	Without flow controls (20 mm)	With flow controls (20 mm)
3/8" NPTF	<input type="radio"/> EBM47A-01GBK-xx	<input type="radio"/> EBM47A-01HBK-xx

Number of stations (03=3 stations)

Note: clic for valves mounted on base of the factory (add - 9 to the model number).
add-a-unit stations may be added to above bars.
Maximum length for add-a-unit is 4 stations.

OPTIONS

EBM47A-01GBK-xx

- clic replace with "C" for add-a-unit.

**TECHNICAL
DATA**

Fluid :	Compressed air, vacuum, inert gases
Pressure range :	Vacuum to 120 PSI
Lubrication :	Not required, if used select a medium aniline point lubricant (between 180°F and 210°F)
Filtration :	40 µ
Temperature range :	0°F to 120°F (-18°C to 50°C)
Orifice :	4.3 mm
Flow (at 6 bar, ΔP=1bar) :	5.2 W : 0.50C _v , 2.4 W : 0.30C _v , 1.8 W : 0.25C _v , 1.0 W : 0.25C _v
Coil :	General purpose class A, continuous duty, encapsulated
Voltage range :	-15% to +10% of nominal voltage
Power :	5.2 W - 2.4 W - 1.8 W - 1.0 W
Response times :	Energize : 14.0 ms
(with 5.2 W coil)	De-energize : 5.0 ms

- Note : • Valve and coil are not interchangeable.
- Spare parts : • Seal between valve and bar : 16629. • Mounting screw (x2) : 35043. • Valve blanking plate : M-47002.
• Flow control kit (x2) : N-37001. End plate kit : M-47004-01.
- Options : • Isolation of inlet and/or exhaust. Special bar. Consult factory. • BSPP Threads.

DIMENSIONS

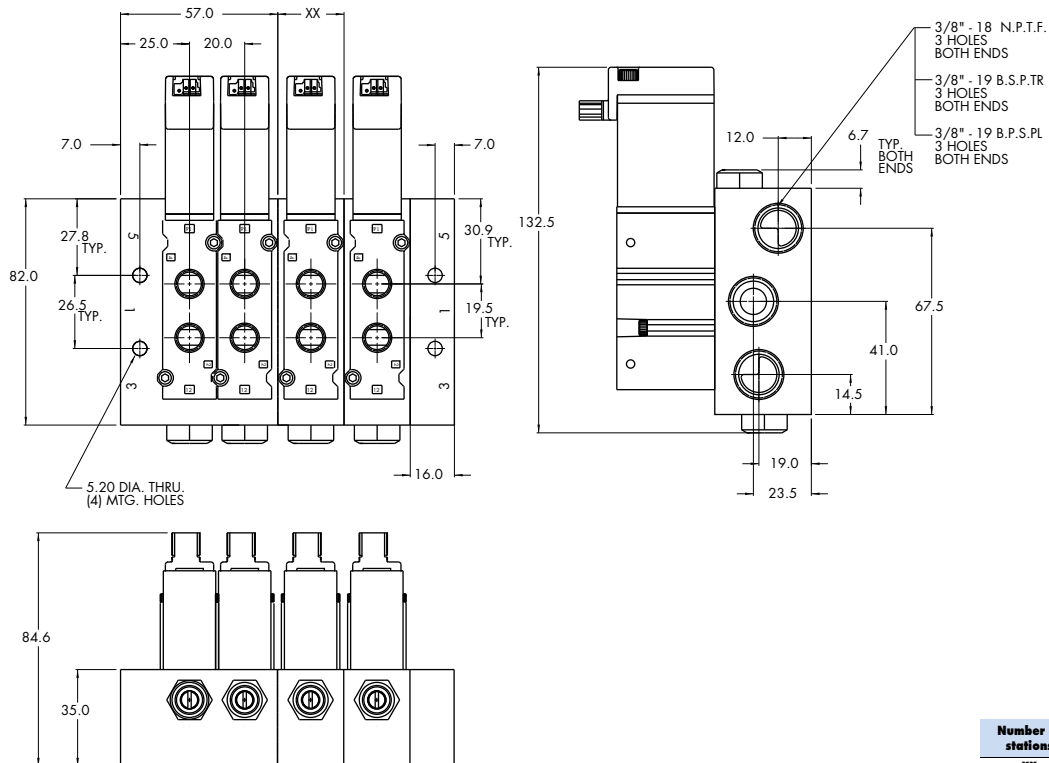

Number of stations	1	2	3	4
XX	24.0	44.0	64.0	84.0

Function	Port size	Flow [Max]	Circuit bar mounting	Profile
5/2	1/8" - 1/4" 6 mm tube receptacle	0.5C_v	add-on style non plug-in cyl. ports in base with opt. F. C.	35 mm

OPERATIONAL BENEFITS

1. Direct solenoid operated valve.
2. Balanced poppet, immune to variations of pressure.
3. Short stroke with high flow.
4. The patented solenoid develops high shifting forces.
5. Powerful return spring.
6. Manual operator standard on all valves.



HOW TO ORDER

47A-xxx-Hxxx-xxx

HOW TO ORDER VALVE FOR CIRCUIT BAR MOUNTING

Port size (see base)	Valve
Valve less base	 <input type="radio"/> 47A-LI0-Hxxx-xxx

SOLENOID OPERATOR >

H **XX X- X XX'**

XX Voltage	X Wire length	X Manual operator	XX Electrical connection
<input type="radio"/> DA 24VDC (5.2 W)	<input type="radio"/> A 18"	<input type="radio"/> I Non-locking	<input type="radio"/> BA Flying leads
<input type="radio"/> DB 24VDC (2.4 W)	<input type="radio"/> C 36"		<input type="radio"/> BC Flying leads with light
<input type="radio"/> DC 24VDC (1.8 W)	<input type="radio"/> x Other Options		<input type="radio"/> MA Plug-in wire assy
<input type="radio"/> DD 24VDC (1.0 W)			<input type="radio"/> MC Plug-in wire assy with light
<input type="radio"/> AA 120VAC (must use with rectified connector)			<input type="radio"/> HA Plug-in connector with rectifier and light
<input type="radio"/> xx Other Options			<input type="radio"/> xx Other Options

EBM47A-xxxxx-xx

HOW TO ORDER CIRCUIT BAR

Port size	Bottom cylinder ports (18 mm)	Bottom cylinder ports with flow controls (18 mm)
1/8" NPTF	<input type="radio"/> EBM47A-00EBA-xx	<input type="radio"/> EBM47A-00FBA-xx
1/4" NPTF	<input type="radio"/> EBM47A-00EBB-xx	<input type="radio"/> EBM47A-00FBB-xx
6 mm tube receptacle	<input type="radio"/> EBM47A-00EBG-xx	<input type="radio"/> EBM47A-00FBG-xx

Number of stations (03=3 stations)
 Note: clic for valves mounted on base at the factory (add - 9 to the model number).
 add-a-unit stations may be added to above bars. Maximum length for add-a-unit is 4 stations.

OPTIONS

EBM47A-00EBA-xx
 clic replace with "C" for add-a-unit.

**TECHNICAL
DATA**

Fluid :	Compressed air, vacuum, inert gases
Pressure range :	Vacuum to 120 PSI
Lubrication :	Not required, if used select a medium aniline point lubricant (between 180°F and 210°F)
Filtration :	40 µ
Temperature range :	0°F to 120°F (-18°C to 50°C)
Orifice :	4.3 mm
Flow (at 6 bar, ΔP=1bar) :	5.2 W : 0.50C _v , 2.4 W : 0.30C _v , 1.8 W : 0.25C _v , 1.0 W : 0.25C _v
Coil :	General purpose class A, continuous duty, encapsulated
Voltage range :	-15% to +10% of nominal voltage
Power :	5.2 W - 2.4 W - 1.8 W - 1.0 W
Response times :	Energize : 14.0 ms
(with 5.2 W coil)	De-energize : 5.0 ms

- Note : • Valve and coil are not interchangeable.
- Spare parts : • Seal between valve and bar : 16629. • Mounting screw (x2) : 35043. • Valve blanking plate : M-47001.
• Flow control kit (x2) : N-37001. End plate kit : M-47004-01.
- Options : • Isolation of inlet and/or exhaust. Special bar. Consult factory. • BSPP Threads.

DIMENSIONS

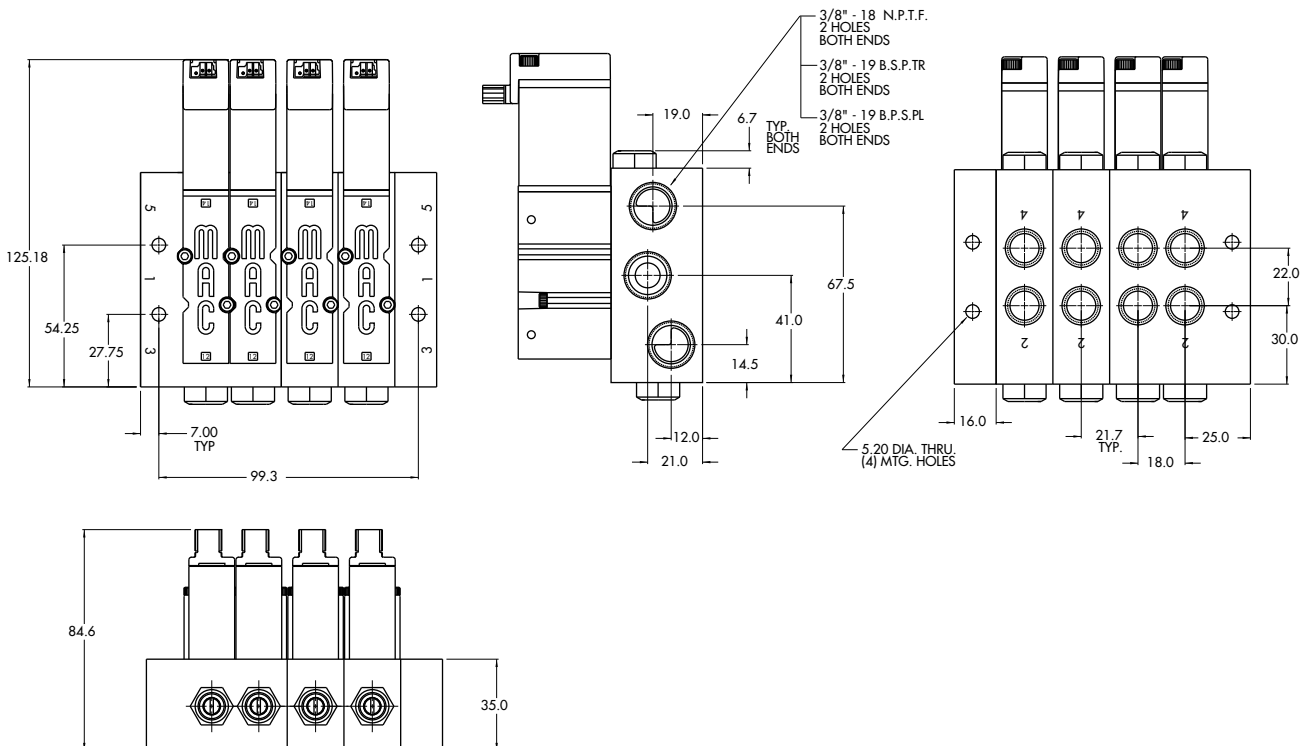



Direct solenoid and solenoid pilot operated valves

Function	Port size (Inlet & Exhaust)	Flow (Max)	Circuit bar mounting	Profile
5/2	3/8"	0.5C_v	non plug-in cyl. ports in valve with opt. Pr. Reg.	44 mm

OPERATIONAL BENEFITS

1. Direct solenoid operated valve.
2. Balanced poppet, immune to variations of pressure.
3. Short stroke with high flow.
4. The patented solenoid develops high shifting forces.
5. Powerful return spring.
6. Manual operator standard on all valves.



HOW TO ORDER

47A-xxx-Hxxx-xxx

HOW TO ORDER VALVE FOR CIRCUIT BAR MOUNTING

Valve port size	Valve
1/8" NPTF	<input type="radio"/> 47A-MG0-Hxxx-xxx
1/4" NPTF	<input type="radio"/> 47A-MH0-Hxxx-xxx

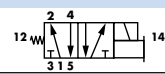

SOLENOID OPERATOR >

H **XX X- X XX'**

XX Voltage	X Wire length	X Manual operator	XX Electrical connection
<input type="radio"/> DA 24VDC (5.2 W)	<input type="radio"/> A 18"	<input type="radio"/> I Non-locking	<input type="radio"/> BA Flying leads
<input type="radio"/> DB 24VDC (2.4 W)	<input type="radio"/> C 36"		<input type="radio"/> BC Flying leads with light
<input type="radio"/> DC 24VDC (1.8 W)	<input type="radio"/> x Other Options		<input type="radio"/> MA Plug-in wire assy
<input type="radio"/> DD 24VDC (1.0 W)			<input type="radio"/> MC Plug-in wire assy with light
<input type="radio"/> AA 120VAC (must use with rectified connector)			<input type="radio"/> HA Plug-in connector with rectifier and light
<input type="radio"/> xx Other Options			<input type="radio"/> xx Other Options

EBM47A-xxxxx-xx

HOW TO ORDER CIRCUIT BAR (REGULATOR ORDERED SEPARATELY)**

Port size COMMON INLET & EXHAUST	Without regulator (20 mm)	With regulator (20 mm)
3/8" NPTF	<input type="radio"/> EBM47A-01NAK-xx	<input type="radio"/> EBM47A-01PAK-xx

Number of stations (03=3 stations)

Note: clic for valves mounted on base at the factory (add - 9 to the model number).

** Pressure Regulators :

- PR47A-GOAx**
- X=A (0 to 120 PSI)
 - X=B (0 to 80 PSI)
 - X=C (0 to 30 PSI)

**TECHNICAL
DATA**

Fluid :	Compressed air, vacuum, inert gases
Pressure range :	Vacuum to 120 PSI
Lubrication :	Not required, if used select a medium aniline point lubricant (between 180°F and 210°F)
Filtration :	40 µ
Temperature range :	0°F to 120°F (-18°C to 50°C)
Orifice :	4.3 mm
Flow (at 6 bar, ΔP=1bar) :	5.2 W : 0.50C _v , 2.4 W : 0.30C _v , 1.8 W : 0.25C _v , 1.0 W : 0.25C _v
Coil :	General purpose class A, continuous duty, encapsulated
Voltage range :	-15% to +10% of nominal voltage
Power :	5.2 W - 2.4 W - 1.8 W - 1.0 W
Response times :	Energize : 14.0 ms
(with 5.2 W coil)	De-energize : 5.0 ms

- Note : • Valve and coil are not interchangeable.
- Spare parts : • Seal between valve and bar : 16629. • Mounting screw (x2) : 35043. • Valve blanking plate : M-47002.
• Regulator blanking plate : R-47003.
- Options : • Isolation of inlet and/or exhaust. Special bar. Consult factory. • BSPP Threads.

DIMENSIONS

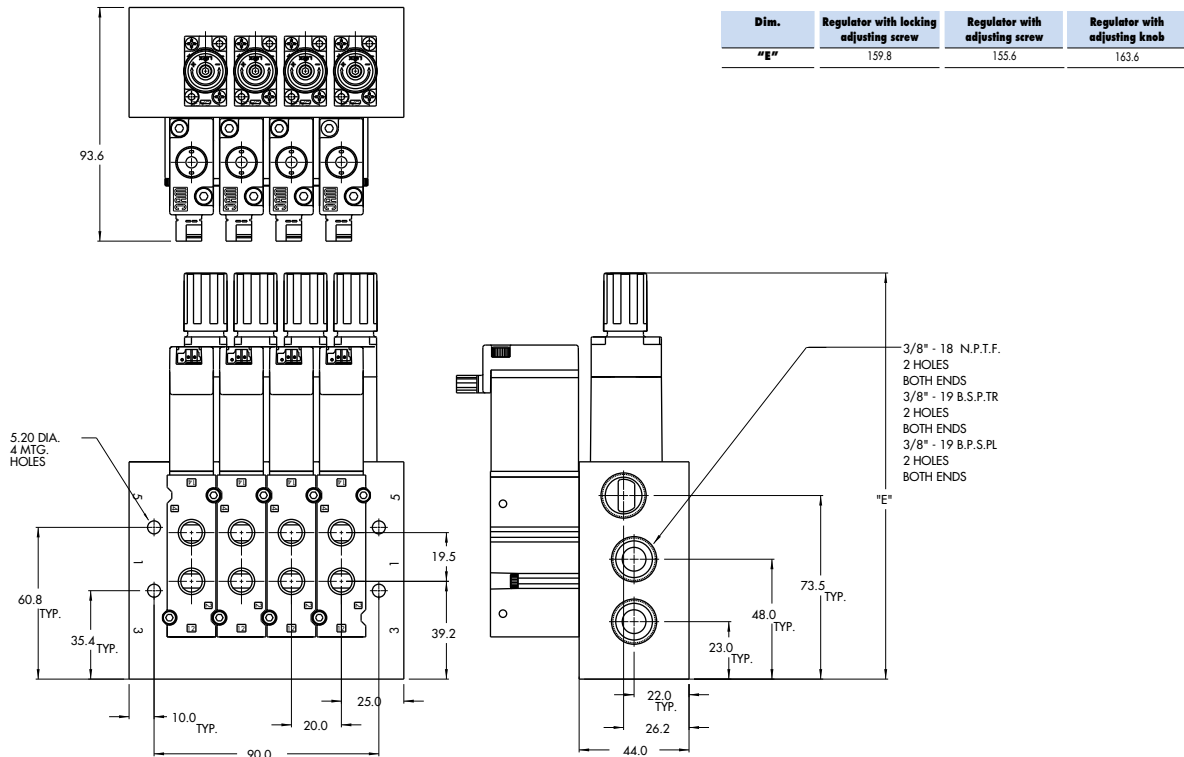

Function	Port size	Flow [Max]	Circuit bar mounting	Profile
5/2	1/8" - 1/4" 6 mm tube receptacle	0.5C_v	non plug-in cyl. ports in base	44 mm

OPERATIONAL BENEFITS

1. Direct solenoid operated valve.
2. Balanced poppet, immune to variations of pressure.
3. Short stroke with high flow.
4. The patented solenoid develops high shifting forces.
5. Powerful return spring.
6. Manual operator standard on all valves.

Reset

HOW TO ORDER

47A-xxx-Hxxx-xxx

HOW TO ORDER VALVE FOR CIRCUIT BAR MOUNTING

Port size (see base)	Valve
Valve less base	 <input type="radio"/> 47A-LI0-Hxxx-xxx

SOLENOID OPERATOR >

H XX X- X XX'

XX Voltage	X Wire length	X Manual operator	XX Electrical connection
<input type="radio"/> DA 24VDC (5.2 W)	<input type="radio"/> A 18"	<input type="radio"/> I Non-locking	<input type="radio"/> BA Flying leads
<input type="radio"/> DB 24VDC (2.4 W)	<input type="radio"/> C 36"		<input type="radio"/> BC Flying leads with light
<input type="radio"/> DC 24VDC (1.8 W)	<input type="radio"/> x Other Options		<input type="radio"/> MA Plug-in wire assy
<input type="radio"/> DD 24VDC (1.0 W)			<input type="radio"/> MC Plug-in wire assy with light
<input type="radio"/> AA 120VAC (must use with rectified connector)			<input type="radio"/> HA Plug-in connector with rectifier and light
<input type="radio"/> xx Other Options			<input type="radio"/> xx Other Options

EBM47A-xxxxx-xx

HOW TO ORDER CIRCUIT BAR

Port size	Side cylinder ports (18 mm)	Bottom cylinder ports (18 mm)
1/8" NPTF	<input type="radio"/> EBM47A-00JAA-xx	<input type="radio"/> EBM47A-00LAA-xx
1/4" NPTF	<input type="radio"/> EBM47A-00JAB-xx	<input type="radio"/> EBM47A-00LAB-xx
6 mm tube receptacle	<input type="radio"/> EBM47A-00JAG-xx	<input type="radio"/> EBM47A-00LAG-xx

Number of stations (03=3 stations)

Note: clic for valves mounted on base at the factory (add - 9 to the model number).

**TECHNICAL
DATA**

Fluid :	Compressed air, vacuum, inert gases
Pressure range :	Vacuum to 120 PSI
Lubrication :	Not required, if used select a medium aniline point lubricant (between 180°F and 210°F)
Filtration :	40 μ
Temperature range :	0°F to 120°F (-18°C to 50°C)
Orifice :	4.3 mm
Flow (at 6 bar, ΔP=1bar) :	5.2 W : 0.50C _v , 2.4 W : 0.30C _v , 1.8 W : 0.25C _v , 1.0 W : 0.25C _v
Coil :	General purpose class A, continuous duty, encapsulated
Voltage range :	-15% to +10% of nominal voltage
Power :	5.2 W - 2.4 W - 1.8 W - 1.0 W
Response times :	Energize : 14.0 ms
(with 5.2 W coil)	De-energize : 5.0 ms

- Note : • Valve and coil are not interchangeable.
- Spare parts : • Seal between valve and bar : 16629. • Mounting screw (x2) : 35043. • Valve blanking plate : M-47001.
- Options : • Isolation of inlet and/or exhaust. Special bar. Consult factory. • BSPP Threads.

DIMENSIONS

Number of stations	1	2	3	4	5	6	7	8	9	10
"A"	-	68.0	86.0	104.0	122.0	140.0	158.0	178.0	194.0	212.0
"B"	25.90	25.90	25.90	25.90	25.90	25.90	25.90	25.90	25.90	25.90
"C"	28.60	28.60	28.60	28.60	28.60	28.60	28.60	28.60	28.60	28.60
"D"	25.00	25.00	25.00	25.00	25.00	25.00	25.00	25.00	25.00	25.00
1/4" Port	25.00	25.00	25.00	25.00	25.00	25.00	25.00	25.00	25.00	25.00
M6 Carstick port					N/A					

Dimensions are based on 18 mm centerline spacing

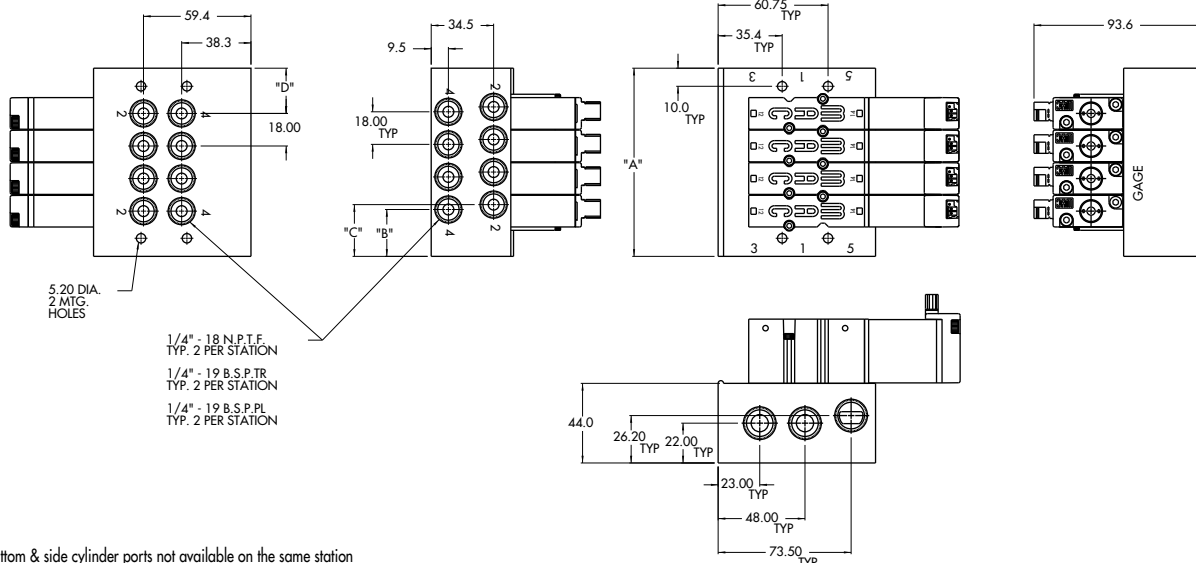

Note: Bottom & side cylinder ports not available on the same station

Consult "Precautions" before use, installation or service of MAC Valves.

Function	Port size	Flow [Max]	Circuit bar mounting	Profile
5/2	1/8" - 1/4" 6 mm tube receptacle	0.5C_v	non plug-in cyl. ports in base with Pr. Reg.	44 mm

OPERATIONAL BENEFITS

1. Direct solenoid operated valve.
2. Balanced poppet, immune to variations of pressure.
3. Short stroke with high flow.
4. The patented solenoid develops high shifting forces.
5. Powerful return spring.
6. Manual operator standard on all valves.

Reset

HOW TO ORDER

47A-xxx-Hxxx-xxx

HOW TO ORDER VALVE FOR CIRCUIT BAR MOUNTING

Port size (see base)	Valve
Valve less base	 <input type="radio"/> 47A-LI0-Hxxx-xxx

SOLENOID OPERATOR >

H XX X- X XX'

XX Voltage	X Wire length	X Manual operator	XX Electrical connection
<input type="radio"/> DA 24VDC (5.2 W)	<input type="radio"/> A 18"	<input type="radio"/> I Non-locking	<input type="radio"/> BA Flying leads
<input type="radio"/> DB 24VDC (2.4 W)	<input type="radio"/> C 36"		<input type="radio"/> BC Flying leads with light
<input type="radio"/> DC 24VDC (1.8 W)	<input type="radio"/> x Other Options		<input type="radio"/> MA Plug-in wire assy
<input type="radio"/> DD 24VDC (1.0 W)			<input type="radio"/> MC Plug-in wire assy with light
<input type="radio"/> AA 120VAC (must use with rectified connector)			<input type="radio"/> HA Plug-in connector with rectifier and light
<input type="radio"/> xx Other Options			<input type="radio"/> xx Other Options

EBM47A-xxxxx-xx

HOW TO ORDER CIRCUIT BAR (REGULATOR ORDERED SEPARATELY)**

Port size	Side cylinder ports (18 mm)	Bottom cylinder ports (18 mm)
1/8" NPTF	<input type="radio"/> EBM47A-00KAA-xx	<input type="radio"/> EBM47A-00MAA-xx
1/4" NPTF	<input type="radio"/> EBM47A-00KAB-xx	<input type="radio"/> EBM47A-00MAB-xx
6 mm tube receptacle	<input type="radio"/> EBM47A-00KAG-xx	<input type="radio"/> EBM47A-00MAG-xx

Number of stations (03=3 stations)
 Note: clic for valves mounted on base at the factory (add - 9 to the model number).

** Pressure Regulators :

- PR47A-GOAx
-
-
- X=A (0 to 120 PSI)
-
-
- X=B (0 to 80 PSI)
-
-
- X=C (0 to 30 PSI)

**TECHNICAL
DATA**

Fluid :	Compressed air, vacuum, inert gases
Pressure range :	Vacuum to 120 PSI
Lubrication :	Not required, if used select a medium aniline point lubricant (between 180°F and 210°F)
Filtration :	40 µ
Temperature range :	0°F to 120°F (-18°C to 50°C)
Orifice :	4.3 mm
Flow (at 6 bar, ΔP=1bar) :	5.2 W : 0.50C _v , 2.4 W : 0.30C _v , 1.8 W : 0.25C _v , 1.0 W : 0.25C _v
Coil :	General purpose class A, continuous duty, encapsulated
Voltage range :	-15% to +10% of nominal voltage
Power :	5.2 W - 2.4 W - 1.8 W - 1.0 W
Response times :	Energize : 14.0 ms
(with 5.2 W coil)	De-energize : 5.0 ms

- Note : • Valve and coil are not interchangeable.
- Spare parts : • Seal between valve and bar : 16629. • Mounting screw (x2) : 35043. • Valve blanking plate : M-47001. • Regulator blanking plate : R-47003.
- Options : • Isolation of inlet and/or exhaust. Special bar. Consult factory. • BSPP Threads.

DIMENSIONS

Number of stations	1	2	3	4	5	6	7	8	9	10
"A"	-	68.0	86.0	104.0	122.0	140.0	158.0	178.0	194.0	212.0
"B"	25.90	25.90	25.90	25.90	25.90	25.90	25.90	25.90	25.90	25.90
"C"	28.60	28.60	28.60	28.60	28.60	28.60	28.60	28.60	28.60	28.60
"D"	25.00	25.00	25.00	25.00	25.00	25.00	25.00	25.00	25.00	25.00
1/4" Port	25.00	25.00	25.00	25.00	25.00	25.00	25.00	25.00	25.00	25.00
M6 Carstick port						N/A				

Dimensions are based on 18 mm centerline spacing

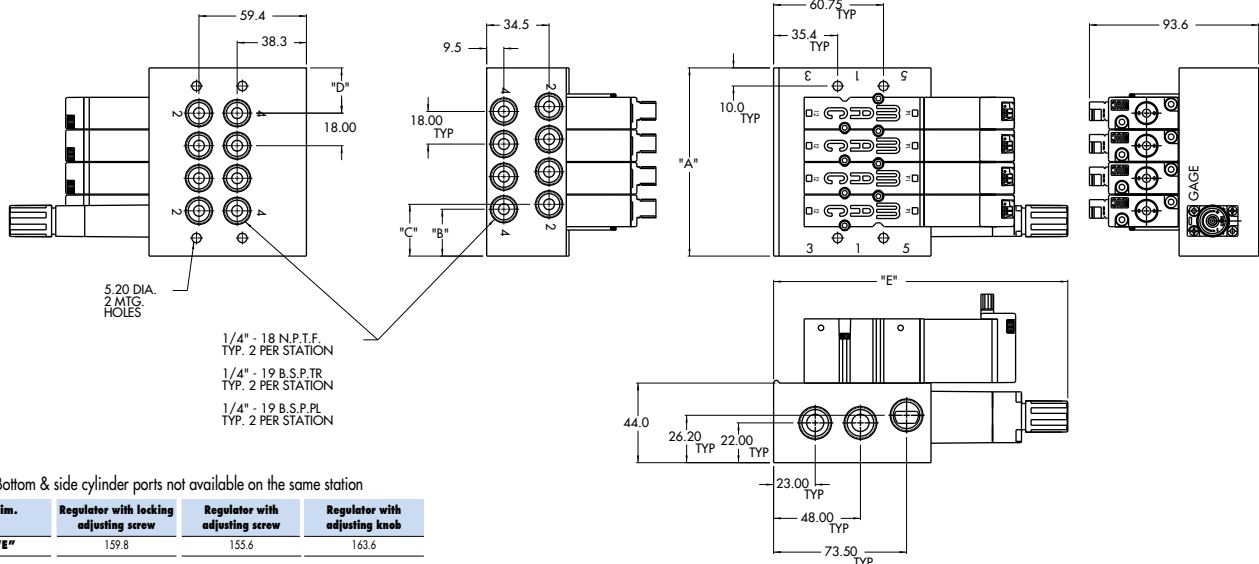

Function	Port size	Flow [Max]	Circuit bar mounting	Profile
5/2	1/8" - 1/4" 6 mm tube receptacle	0.5C_v	add-on style non plug-in cyl. ports in base	44 mm

OPERATIONAL BENEFITS

1. Direct solenoid operated valve.
2. Balanced poppet, immune to variations of pressure.
3. Short stroke with high flow.
4. The patented solenoid develops high shifting forces.
5. Powerful return spring.
6. Manual operator standard on all valves.

Reset

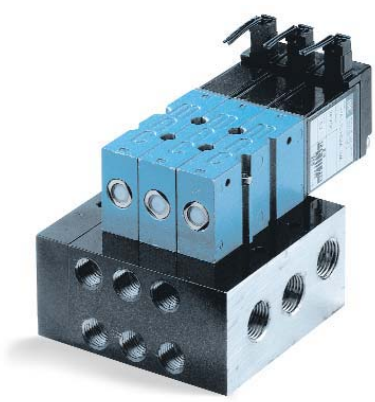

HOW TO ORDER

47A-xxx-Hxxx-xxx

HOW TO ORDER VALVE FOR CIRCUIT BAR MOUNTING

Port size (see base)	Valve
Valve less base	 <input type="radio"/> 47A-LI0-Hxxx-xxx

SOLENOID OPERATOR >

H **XX X- X XX'**

XX Voltage	X Wire length	X Manual operator	XX Electrical connection
<input type="radio"/> DA 24VDC (5.2 W)	<input type="radio"/> A 18"	<input type="radio"/> I Non-locking	<input type="radio"/> BA Flying leads
<input type="radio"/> DB 24VDC (2.4 W)	<input type="radio"/> C 36"		<input type="radio"/> BC Flying leads with light
<input type="radio"/> DC 24VDC (1.8 W)	<input type="radio"/> x Other Options		<input type="radio"/> MA Plug-in wire assy
<input type="radio"/> DD 24VDC (1.0 W)			<input type="radio"/> MC Plug-in wire assy with light
<input type="radio"/> AA 120VAC (must use with rectified connector)			<input type="radio"/> HA Plug-in connector with rectifier and light
<input type="radio"/> xx Other Options			<input type="radio"/> xx Other Options

EBM47A-xxxxx-xx

HOW TO ORDER CIRCUIT BAR

Port size	Side cylinder ports (18 mm)	Bottom cylinder ports (18 mm)
1/8" NPTF	<input type="radio"/> EBM47A-00JBA-xx	<input type="radio"/> EBM47A-00LBA-xx
1/4" NPTF	<input type="radio"/> EBM47A-00JBB-xx	<input type="radio"/> EBM47A-00LBB-xx
6 mm tube receptacle	<input type="radio"/> EBM47A-00JBG-xx	<input type="radio"/> EBM47A-00LBG-xx

Number of stations (03=3 stations)
 Note: clic for valves mounted on base at the factory (add - 9 to the model number).
 add-a-unit stations may be added to above bars. Maximum length for add-a-unit is 4 stations.

OPTIONS

EBM47A-00JBA-xx
 clic replace with "C" for add-a-unit.

**TECHNICAL
DATA**

Fluid :	Compressed air, vacuum, inert gases
Pressure range :	Vacuum to 120 PSI
Lubrication :	Not required, if used select a medium aniline point lubricant (between 180°F and 210°F)
Filtration :	40 µ
Temperature range :	0°F to 120°F (-18°C to 50°C)
Orifice :	4.3 mm
Flow (at 6 bar, ΔP=1bar) :	5.2 W : 0.50C _v , 2.4 W : 0.30C _v , 1.8 W : 0.25C _v , 1.0 W : 0.25C _v
Coil :	General purpose class A, continuous duty, encapsulated
Voltage range :	-15% to +10% of nominal voltage
Power :	5.2 W - 2.4 W - 1.8 W - 1.0 W
Response times :	Energize : 14.0 ms
(with 5.2 W coil)	De-energize : 5.0 ms

- Note : • Valve and coil are not interchangeable.
- Spare parts : • Seal between valve and bar : 16629. • Mounting screw (x2) : 35043. • Valve blanking plate : M-47001. • End plate kit : M-47005-01.
- Options : • Isolation of inlet and/or exhaust. Special bar. Consult factory. • BSPP Threads.

DIMENSIONS

Number of stations	1	2	3	4	5	6	7	8	9	10
"C" w/regulator	-	56.1	74.1	92.1	110.1	128.1	146.1	164.1	182.1	200.1
"C" w/o regulator	-	56.1	74.1	92.1	110.1	128.1	146.1	164.1	182.1	200.1
"D"	21.7	39.7	57.7	75.7	-	-	-	-	-	-

Dimensions are based on 18 mm centerline spacing
 Note: Bottom & side cylinder ports not available on the same station

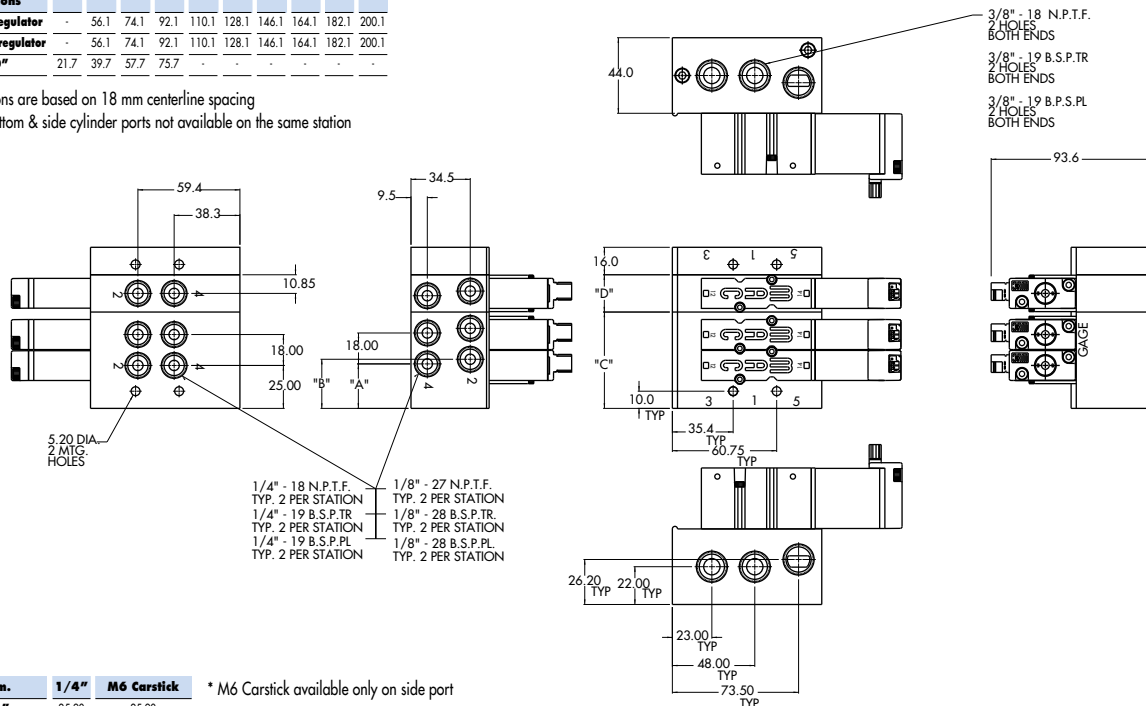

Dim.	1/4"	M6 Carstick
"A"	25.90	25.90
"B"	28.60	28.60

* M6 Carstick available only on side port

Function	Port size	Flow [Max]	Circuit bar mounting	Profile
5/2	1/8" - 1/4" 6 mm tube receptacle	0.5C_v	add-on style non plug-in cyl. ports in base with Pr. Reg.	44 mm

OPERATIONAL BENEFITS

1. Direct solenoid operated valve.
2. Balanced poppet, immune to variations of pressure.
3. Short stroke with high flow.
4. The patented solenoid develops high shifting forces.
5. Powerful return spring.
6. Manual operator standard on all valves.



HOW TO ORDER

47A-xxx-Hxxx-xxx

HOW TO ORDER VALVE FOR CIRCUIT BAR MOUNTING

Port size (see base)	Valve
Valve less base	 <input type="radio"/> 47A-LI0-Hxxx-xxx

SOLENOID OPERATOR >

H **XX X- X XX***

XX Voltage	X Wire length	X Manual operator	XX Electrical connection
<input type="radio"/> DA 24VDC (5.2 W)	<input type="radio"/> A 18"	<input type="radio"/> I Non-locking	<input type="radio"/> BA Flying leads
<input type="radio"/> DB 24VDC (2.4 W)	<input type="radio"/> C 36"		<input type="radio"/> BC Flying leads with light
<input type="radio"/> DC 24VDC (1.8 W)	<input type="radio"/> x Other Options		<input type="radio"/> MA Plug-in wire assy
<input type="radio"/> DD 24VDC (1.0 W)			<input type="radio"/> MC Plug-in wire assy with light
<input type="radio"/> AA 120VAC (must use with rectified connector)			<input type="radio"/> HA Plug-in connector with rectifier and light
<input type="radio"/> xx Other Options			<input type="radio"/> xx Other Options

EBM47A-xxxxx-xx

HOW TO ORDER CIRCUIT BAR (REGULATOR ORDERED SEPARATELY)**

Port size	Side cylinder ports (18 mm)	Bottom cylinder ports (18 mm)
1/8" NPTF	<input type="radio"/> EBM47A-00KBA-xx	<input type="radio"/> EBM47A-00MBA-xx
1/4" NPTF	<input type="radio"/> EBM47A-00KBB-xx	<input type="radio"/> EBM47A-00MBB-xx
6 mm tube receptacle	<input type="radio"/> EBM47A-00KBG-xx	<input type="radio"/> EBM47A-00MBG-xx

Number of stations (03=3 stations)
 Note : clic for valves mounted on base at the factory (add - 9 to the model number).
 add-a-unit stations may be added to above bars. Maximum length for add-a-unit is 4 stations.

OPTIONS

EBM47A-00KBA-xx

- clic replace with "C" for add-a-unit.

** Pressure Regulators :

- PR47A-GOAx**
- X=A (0 to 120 PSI)
 - X=B (0 to 80 PSI)
 - X=C (0 to 30 PSI)

**TECHNICAL
DATA**

Fluid :	Compressed air, vacuum, inert gases
Pressure range :	Vacuum to 120 PSI
Lubrication :	Not required, if used select a medium aniline point lubricant (between 180°F and 210°F)
Filtration :	40 µ
Temperature range :	0°F to 120°F (-18°C to 50°C)
Orifice :	4.3 mm
Flow (at 6 bar, ΔP=1bar) :	5.2 W : 0.50C _v , 2.4 W : 0.30C _v , 1.8 W : 0.25C _v , 1.0 W : 0.25C _v
Coil :	General purpose class A, continuous duty, encapsulated
Voltage range :	-15% to +10% of nominal voltage
Power :	5.2 W - 2.4 W - 1.8 W - 1.0 W
Response times :	Energize : 14.0 ms
(with 5.2 W coil)	De-energize : 5.0 ms

- Note : • Valve and coil are not interchangeable.
- Spare parts : • Seal between valve and bar : 16629. • Mounting screw (x2) : 35043. • Valve blanking plate : M-47001. • End plate kit : M-47005-01. • Regulator blanking plate : R-47003.
- Options : • Isolation of inlet and/or exhaust. Special bar. Consult factory. • BSPP Threads.

DIMENSIONS

Number of stations	1	2	3	4	5	6	7	8	9	10
"C" w/regulator	-	56.1	74.1	92.1	110.1	128.1	146.1	164.1	182.1	200.1
"C" w/o regulator	-	56.1	74.1	92.1	110.1	128.1	146.1	164.1	182.1	200.1
"D"	21.7	39.7	57.7	75.7	-	-	-	-	-	-

Dimensions are based on 18 mm centerline spacing
 Note: Bottom & side cylinder ports not available on the same station

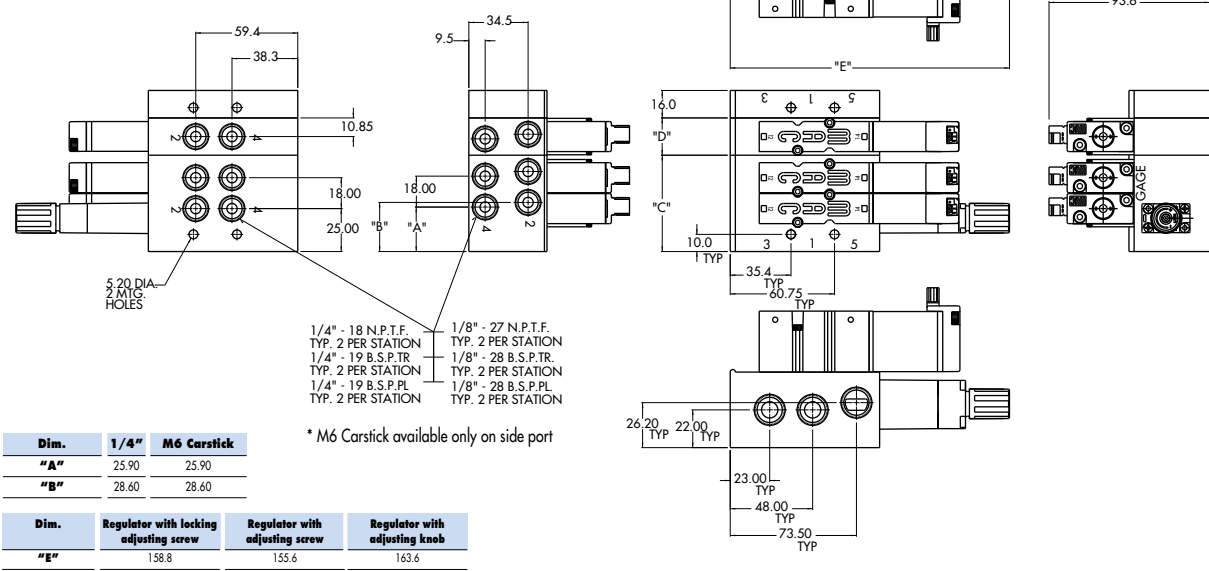

Function	Port size	Flow [Max]	Circuit bar mounting
5/2	1/8" - 1/4" 6 mm tube receptacle	0.5C_v	plug-in

OPERATIONAL BENEFITS

1. Balanced poppet, immune to variations of pressure.
2. Short stroke with high flow.
3. The patented solenoid develops high shifting forces.
4. Powerful return spring.
5. Manual operator standard on all valves.
6. Direct solenoid operated.



HOW TO ORDER

47A-xxx-HxxP-xxx

HOW TO ORDER VALVE FOR "PLUG-IN" CIRCUIT BAR

Valve less base	Valve
	<input type="radio"/> 47A-LI0-HxxP-xxx

SOLENOID OPERATOR >

H **XX** P- X **XX**'

XX Voltage	X Manual operator	XX Electrical connection
<input type="radio"/> DA 24VDC (5.2 W)	<input type="radio"/> 1 Non-locking	<input type="radio"/> FA Plug-in
<input type="radio"/> DB 24VDC (2.4 W)		<input type="radio"/> FC Plug-in with light
<input type="radio"/> DC 24VDC (1.8 W)		<input type="radio"/> FE Plug-in with suppression diode
<input type="radio"/> DD 24VDC (1.0 W)		<input type="radio"/> FG Plug-in with suppression diode with LED light
<input type="radio"/> AA 120VAC (Mod. No. required see below)		<input type="radio"/> xx Other Options
<input type="radio"/> xx Other Options		

HOW TO ORDER "PLUG-IN" CIRCUIT BAR

ECD47A-xxxxx-xxxx

Port size	Spacing mm	Side cylinder ports	Bottom cylinder ports
1/8" NPTF	18	<input type="radio"/> ECD47A-00AAA-A0xx	<input type="radio"/> ECD47A-00BAA-A0xx
1/4" NPTF	18	<input type="radio"/> ECD47A-00AAB-A0xx	<input type="radio"/> ECD47A-00BAB-A0xx
6 mm tube receptacle	18	<input type="radio"/> ECD47A-00AAG-A0xx	<input type="radio"/> ECD47A-00BAG-A0xx
1/8" NPTF	30	<input type="radio"/> ECD47A-01AAA-C0xx	<input type="radio"/> ECD47A-01BAA-C0xx
1/4" NPTF	30	<input type="radio"/> ECD47A-01AAB-C0xx	<input type="radio"/> ECD47A-01BAB-C0xx
6 mm tube receptacle	30	<input type="radio"/> ECD47A-01AAG-C0xx	<input type="radio"/> ECD47A-01BAG-C0xx

Number of stations (03=3 stations)

Note: clic for valves mounted on base at the factory (add - 9 to the model number).
for AC voltage use mod. FWR2 after circuit bar model number.
for multi-pin connector (9, 15 or 25).

- A0 = without light
- AA = with light (120V)
- AB = with light (240V)
- AD = with light (24V)
- C0 = terminal strip
- CA = terminal strip with light (120V)
- CB = terminal strip with light (240V)
- CD = terminal strip with light (24V)

**TECHNICAL
DATA**

Fluid :	Compressed air, vacuum, inert gases
Pressure range :	Vacuum to 120 PSI
Lubrication :	Not required, if used select a medium aniline point lubricant (between 180°F and 210°F)
Filtration :	40 µ
Temperature range :	0°F to 120°F (-18°C to 50°C)
Orifice :	4.3 mm
Flow (at 6 bar, ΔP=1bar) :	5.2 W : 0.50C _v , 2.4 W : 0.30C _v , 1.8 W : 0.25C _v , 1.0 W : 0.25C _v
Coil :	General purpose class A, continuous duty, encapsulated
Voltage range :	-15% to +10% of nominal voltage
Power :	5.2 W - 2.4 W - 1.8 W - 1.0 W
Response times :	Energize : 14.0 ms
(with 5.2 W coil)	De-energize : 5.0 ms

- Note : • Valve and coil are not interchangeable.
- Spare parts : • Seal between valve and bar : 16629. • Mounting screw (x2) : 35043. • Valve blanking plate : M-47001.
• Base wire plug-in protector : 16520.
- Options : • Isolation of inlet and/or exhaust. Special bar. Consult factory. • BSPP Threads.

DIMENSIONS

Number of stations	1	2	3	4	5	6	7	8	9	10
"E"	46.0	64.0	82.0	100.0	118.0	136.0	154.0	172.0	190.0	208.0

Dimensions are based on 18 mm centerline spacing
Note: Bottom & side cylinder ports not available on the same station

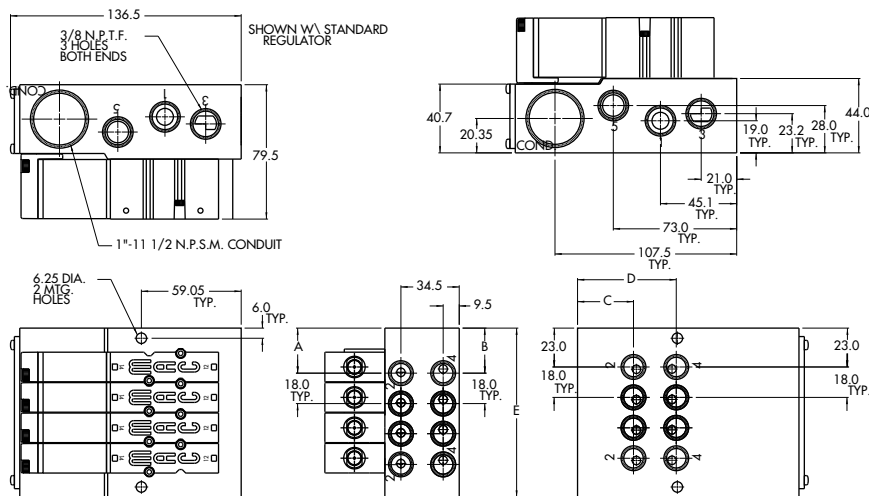

Dim.	1/4"	1/8"	6 mm Legris
"A"	26.65	26.15	25.65
"B"	26.65	24.2	25.65
"C"	33.1	34.8	34.8
"D"	58.4	55.9	55.9

Function	Port size	Flow [Max]	Circuit bar mounting
5/2	1/8" - 1/4"	0.5C_v	plug-in with Pr. Reg.

OPERATIONAL BENEFITS

1. Balanced poppet, immune to variations of pressure.
2. Short stroke with high flow.
3. The patented solenoid develops high shifting forces.
4. Powerful return spring.
5. Manual operator standard on all valves.
6. Direct solenoid operated.

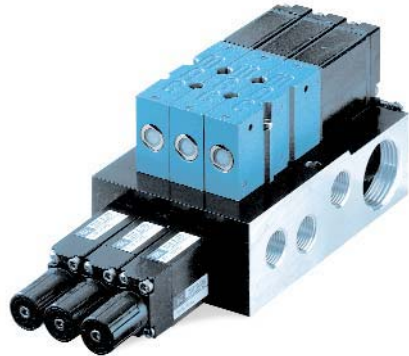

HOW TO ORDER

47A-xxx-HxxP-xxx

HOW TO ORDER VALVE FOR "PLUG-IN" CIRCUIT BAR

	Valve
Valve less base	<input type="radio"/> 47A-LI0-HxxP-xxx

SOLENOID OPERATOR >

H **XX** P- X **XX**'

XX Voltage	X Manual operator	XX Electrical connection
<input type="radio"/> DA 24VDC (5.2 W)	<input type="radio"/> 1 Non-locking	<input type="radio"/> FA Plug-in
<input type="radio"/> DB 24VDC (2.4 W)		<input type="radio"/> FC Plug-in with light
<input type="radio"/> DC 24VDC (1.8 W)		<input type="radio"/> FE Plug-in with suppression diode
<input type="radio"/> DD 24VDC (1.0 W)		<input type="radio"/> FG Plug-in with suppression diode with LED light
<input type="radio"/> AA 120VAC (Mod. No. required see below)		<input type="radio"/> xx Other Options
<input type="radio"/> xx Other Options		

HOW TO ORDER "PLUG-IN" CIRCUIT BAR (REGULATORS ORDERED SEPARATELY)**

ECD47A-xxxxx-xxxx

Port size	Spacing mm	Bottom cylinder ports
1/8" NPTF	18	<input type="radio"/> ECD47A-00CAA-A0xx
1/4" NPTF	18	<input type="radio"/> ECD47A-00CAB-A0xx
1/8" NPTF	30	<input type="radio"/> ECD47A-01CAA-C0xx
1/4" NPTF	30	<input type="radio"/> ECD47A-01CAB-C0xx

Number of stations (03=3 stations)
 Note : clic for valves mounted on base at the factory (add - 9 to the model number).
 for AC voltage use mod. FWR2 after circuit bar model number.
 for multi-pin connector (9, 15 or 25).

- ** Pressure Regulators :
- PR47A-GOAx**
- X=A (0 to 120 PSI)
 - X=B (0 to 80 PSI)
 - X=C (0 to 30 PSI)
 - A0 = without light
 - AA = with light (120V)
 - AB = with light (240V)
 - AD = with light (24V)
 - C0 = terminal strip
 - CA = terminal strip with light (120V)
 - CB = terminal strip with light (240V)
 - CD = terminal strip with light (24V)

**TECHNICAL
DATA**

Fluid :	Compressed air, vacuum, inert gases
Pressure range :	Vacuum to 120 PSI
Lubrication :	Not required, if used select a medium aniline point lubricant (between 180°F and 210°F)
Filtration :	40 µ
Temperature range :	0°F to 120°F (-18°C to 50°C)
Orifice :	4.3 mm
Flow (at 6 bar, ΔP=1bar) :	5.2 W : 0.50C _v , 2.4 W : 0.30C _v , 1.8 W : 0.25C _v , 1.0 W : 0.25C _v
Coil :	General purpose class A, continuous duty, encapsulated
Voltage range :	-15% to +10% of nominal voltage
Power :	5.2 W - 2.4 W - 1.8 W - 1.0 W
Response times :	Energize : 14.0 ms
(with 5.2 W coil)	De-energize : 5.0 ms

- Note : • Valve and coil are not interchangeable.
- Spare parts : • Seal between valve and bar : 16629. • Mounting screw (x2) : 35043. • Valve blanking plate : M-47001.
• Base wire plug-in protector : 16520. • Regulator blanking plate : R-47003.
- Options : • Isolation of inlet and/or exhaust. Special bar. Consult factory. • BSPP Threads.

DIMENSIONS

Number of stations	1	2	3	4	5	6	7	8	9	10
"E"	46.0	64.0	82.0	100.0	118.0	136.0	154.0	172.0	190.0	208.0

Dimensions are based on 18 mm centerline spacing
Note: Bottom & side cylinder ports not available on the same station

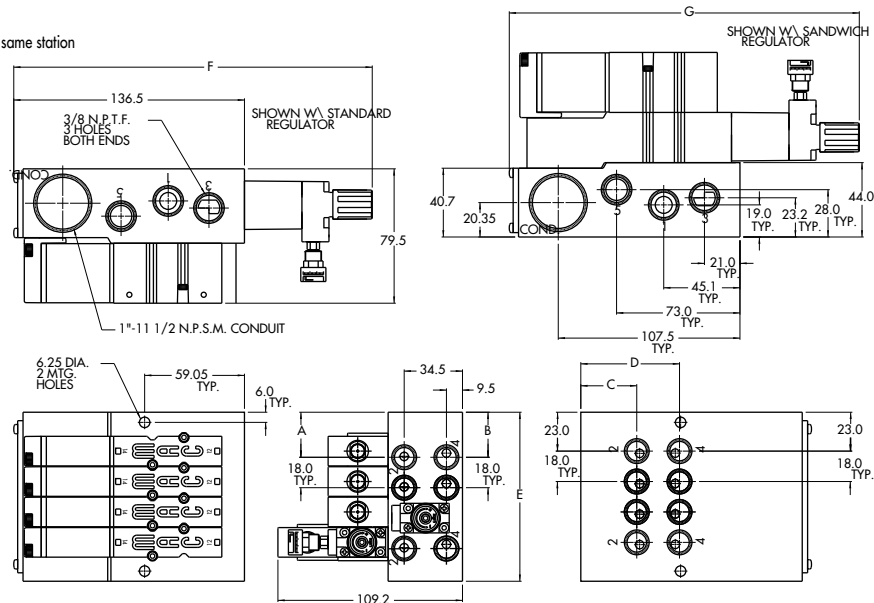

Dim.	1/4"	1/8"	6 mm Legris
"A"	26.65	26.15	25.65
"B"	26.65	24.2	25.65
"C"	33.1	34.8	34.8
"D"	58.4	55.9	55.9

Dim.	Regulator with locking adjusting screw	Regulator with adjusting screw	Regulator with adjusting knob
"F"	209.3	205.1	212.1
"G"	204.3	200.1	207.1

Function	Port size	Flow (Max)	Circuit bar mounting
5/2	1/8" - 1/4" 6 mm tube receptacle	0.5C _v	add-on style plug-in

OPERATIONAL BENEFITS

1. Balanced poppet, immune to variations of pressure.
2. Short stroke with high flow.
3. The patented solenoid develops high shifting forces.
4. Powerful return spring.
5. Manual operator standard on all valves.
6. Direct solenoid operated.



HOW TO ORDER

47A-xxx-HxxP-xxx

HOW TO ORDER VALVE FOR "PLUG-IN" CIRCUIT BAR

	Valve
Valve less base	<input type="radio"/> 47A-LI0-HxxP-xxx

SOLENOID OPERATOR >

H XX P- X XX'

XX	Voltage	X	Manual operator	XX	Electrical connection
<input type="radio"/> DA	24VDC (5.2 W)	<input type="radio"/> 1	Non-locking	<input type="radio"/> FA	Plug-in
<input type="radio"/> DB	24VDC (2.4 W)			<input type="radio"/> FC	Plug-in with light
<input type="radio"/> DC	24VDC (1.8 W)			<input type="radio"/> FE	Plug-in with suppression diode
<input type="radio"/> DD	24VDC (1.0 W)			<input type="radio"/> FG	Plug-in with suppression diode with LED light
<input type="radio"/> AA	120VAC (Mod. No. required see below)			<input type="radio"/> xx	Other Options
<input type="radio"/> xx	Other Options				

HOW TO ORDER "PLUG-IN" CIRCUIT BAR

ECD47A-xxxxx-xxxx

Port size	Spacing mm	Side cylinder ports	Bottom cylinder ports
1/8" NPTF	18	<input type="radio"/> ECD47A-00ABA-A0xx	<input type="radio"/> ECD47A-00BBA-A0xx
1/4" NPTF	18	<input type="radio"/> ECD47A-00ABB-A0xx	<input type="radio"/> ECD47A-00BBB-A0xx
6 mm tube receptacle	18	<input type="radio"/> ECD47A-00ABG-A0xx	<input type="radio"/> ECD47A-00BBG-A0xx
1/8" NPTF	30	<input type="radio"/> ECD47A-01ABA-C0xx	<input type="radio"/> ECD47A-01BBA-C0xx
1/4" NPTF	30	<input type="radio"/> ECD47A-01ABB-C0xx	<input type="radio"/> ECD47A-01BBB-C0xx
6 mm tube receptacle	30	<input type="radio"/> ECD47A-01ABG-C0xx	<input type="radio"/> ECD47A-01BBG-C0xx

Number of stations (03=3 stations)

Note: clic for valves mounted on base at the factory (add - 9 to the model number).
for AC voltage use mod. FWR2 after circuit bar model number.
for multi-pin connector (9, 15 or 25).
add-a-units may be added to above bars.

- A0 = without light
- AA = with light (120V)
- AB = with light (240V)
- AD = with light (24V)
- C0 = terminal strip
- CA = terminal strip with light (120V)
- CB = terminal strip with light (240V)
- CD = terminal strip with light (24V)

**TECHNICAL
DATA**

Fluid :	Compressed air, vacuum, inert gases
Pressure range :	Vacuum to 120 PSI
Lubrication :	Not required, if used select a medium aniline point lubricant (between 180°F and 210°F)
Filtration :	40 µ
Temperature range :	0°F to 120°F (-18°C to 50°C)
Orifice :	4.3 mm
Flow (at 6 bar, ΔP=1bar) :	5.2 W : 0.50C _v , 2.4 W : 0.30C _v , 1.8 W : 0.25C _v , 1.0 W : 0.25C _v
Coil :	General purpose class A, continuous duty, encapsulated
Voltage range :	-15% to +10% of nominal voltage
Power :	5.2 W - 2.4 W - 1.8 W - 1.0 W
Response times :	Energize : 14.0 ms
(with 5.2 W coil)	De-energize : 5.0 ms

- Note : • Valve and coil are not interchangeable.
- Spare parts : • Seal between valve and bar : 16629. • Mounting screw (x2) : 35043. • Valve blanking plate : M-47001.
• Base wire plug-in protector : 16520. • Isolator disc between add-a-units : 28438.
- Options : • Isolation of inlet and/or exhaust. Special bar. Consult factory. • BSPP Threads.

DIMENSIONS

Number of stations	1	2	3	4	5	6	7	8	9	10
"G"	-	51.85	69.85	87.85	105.85	123.85	141.85	159.85	177.85	195.85
"H"	21.70	39.70	57.70	75.70	-	-	-	-	-	-

Dimensions are based on 18 mm centerline spacing
Note: Bottom & side cylinder ports not available on the same station

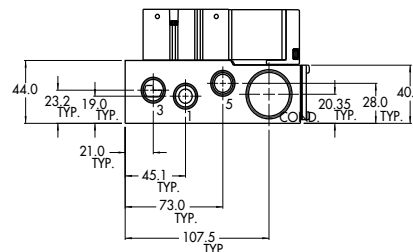
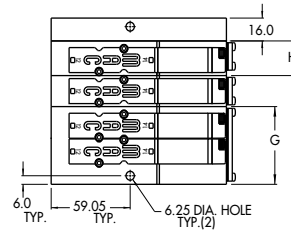
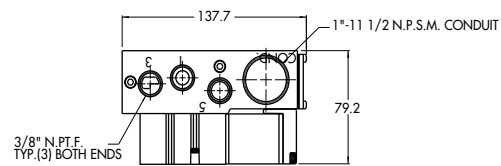
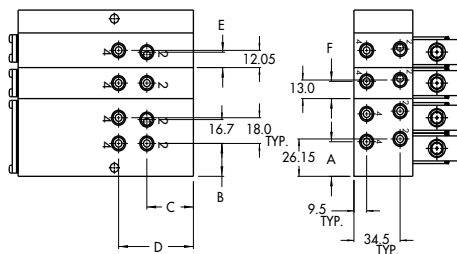

Dim.	1/8"	1/4"	6 mm Legris
"A"	24.20	24.20	25.65
"B"	23.00	23.00	23.00
"C"	34.80	33.10	34.80
"D"	55.90	58.40	55.90
"E"	-	-	-
"F"	12.05	12.00	14.00

Function	Port size	Flow [Max]	Circuit bar mounting
5/2	1/8" - 1/4"	0.5C _v	add-on style plug-in with Pr. Reg.

OPERATIONAL BENEFITS

1. Balanced poppet, immune to variations of pressure.
2. Short stroke with high flow.
3. The patented solenoid develops high shifting forces.
4. Powerful return spring.
5. Manual operator standard on all valves.
6. Direct solenoid operated.



HOW TO ORDER

47A-xxx-HxxP-xxx

HOW TO ORDER VALVE FOR "PLUG-IN" CIRCUIT BAR

Valve less base	Valve
	<input type="radio"/> 47A-LI0-HxxP-xxx

SOLENOID OPERATOR >

H **XX** P- **X** **XX**

XX Voltage	X Manual operator	XX Electrical connection
<input type="radio"/> DA 24VDC (5.2 W)	<input type="radio"/> 1 Non-locking	<input type="radio"/> FA Plug-in
<input type="radio"/> DB 24VDC (2.4 W)		<input type="radio"/> FC Plug-in with light
<input type="radio"/> DC 24VDC (1.8 W)		<input type="radio"/> FE Plug-in with suppression diode
<input type="radio"/> DD 24VDC (1.0 W)		<input type="radio"/> FG Plug-in with suppression diode with LED light
<input type="radio"/> AA 120VAC (Mod. No. required see below)		<input type="radio"/> xx Other Options
<input type="radio"/> xx Other Options		

HOW TO ORDER "PLUG-IN" CIRCUIT BAR (REGULATORS ORDERED SEPARATELY)**

ECD47A-xxxxx-xxxx

Port size	Spacing mm	Bottom cylinder ports
1/8" NPTF	18	<input type="radio"/> ECD47A-00CBA-A0xx
1/4" NPTF	18	<input type="radio"/> ECD47A-00CBB-A0xx
1/8" NPTF	30	<input type="radio"/> ECD47A-01CBA-C0xx
1/4" NPTF	30	<input type="radio"/> ECD47A-01CBB-C0xx

Number of stations (03=3 stations)
 Note: clic for valves mounted on base at the factory (add - 9 to the model number).
 for AC voltage use mod. FWR2 after circuit bar model number.
 for multi-pin connector (9, 15 or 25).
 add-a-units may be added to above bars.

** Pressure Regulators :

PR47A-GOAx

- X=A (0 to 120 PSI)
- X=B (0 to 80 PSI)
- X=C (0 to 30 PSI)
- A0 = without light
- AA = with light (120V)
- AB = with light (240V)
- AD = with light (24V)
- C0 = terminal strip
- CA = terminal strip with light (120V)
- CB = terminal strip with light (240V)
- CD = terminal strip with light (24V)

**TECHNICAL
DATA**

Fluid :	Compressed air, vacuum, inert gases
Pressure range :	Vacuum to 120 PSI
Lubrication :	Not required, if used select a medium aniline point lubricant (between 180°F and 210°F)
Filtration :	40 µ
Temperature range :	0°F to 120°F (-18°C to 50°C)
Orifice :	4.3 mm
Flow (at 6 bar, ΔP=1bar) :	5.2 W : 0.50C _v , 2.4 W : 0.30C _v , 1.8 W : 0.25C _v , 1.0 W : 0.25C _v
Coil :	General purpose class A, continuous duty, encapsulated
Voltage range :	-15% to +10% of nominal voltage
Power :	5.2 W - 2.4 W - 1.8 W - 1.0 W
Response times :	Energize : 14.0 ms
(with 5.2 W coil)	De-energize : 5.0 ms

- Note : • Valve and coil are not interchangeable.
- Spare parts : • Seal between valve and bar : 16629. • Mounting screw (x2) : 35043. • Valve blanking plate : M-47001.
• Base wire plug-in protector : 16520. • Regulator blanking plate : R-47003. • Isolator disc between add-a-units : 28438.
- Options : • Isolation of inlet and/or exhaust. Special bar. Consult factory. • BSPP Threads.

DIMENSIONS

Number of stations	1	2	3	4	5	6	7	8	9	10
"G" w/regulator	54.40	72.40	90.40	108.40	126.40	144.40	162.40	180.40	199.40	
"G" w/o regulator	51.85	69.85	87.85	105.85	123.85	141.85	159.85	177.85	195.85	
"H" w/regulator	24.25	42.25	60.25	78.25	-	-	-	-	-	-
"H" w/o regulator	21.70	39.70	57.70	75.70	-	-	-	-	-	-

Dimensions are based on 18 mm centerline spacing

Note: Bottom & side cylinder ports not available on the same station

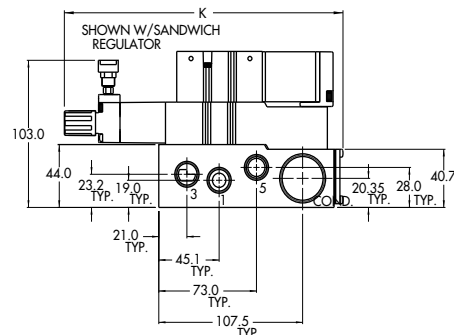
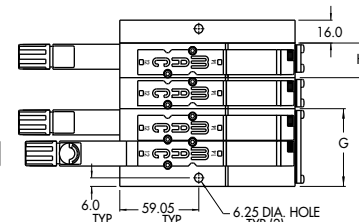
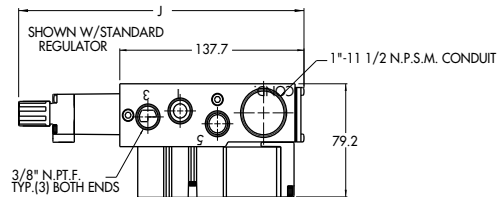
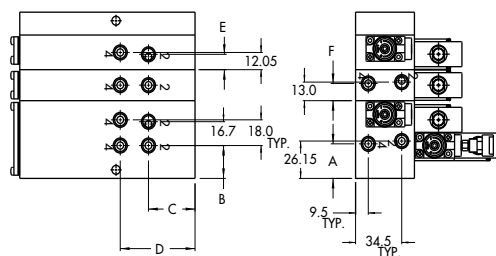

Dim.	1/8"	1/4"	6 mm Legris	1/8" w/regulator	1/4" w/regulator
"A"	24.20	24.20	25.65	-	-
"B"	23.00	23.00	23.00	-	23.00
"C"	34.80	33.10	34.80	34.80	33.10
"D"	55.90	58.40	55.90	55.90	58.40
"E"	-	-	-	10.75	10.85
"F"	12.05	12.00	14.00	-	-

Dim.	Regulator with locking adjusting screw	Regulator with adjusting screw	Regulator with adjusting knob
"J"	209.3	205.1	212.1
"K"	204.3	200.1	207.1

Function	Port size	Flow (Max)	Circuit bar mounting
5/2	1/8" - 1/4" 6 mm tube receptacle	0.5C_v	plug-in add-a-unit stations

OPERATIONAL BENEFITS

1. Balanced poppet, immune to variations of pressure.
2. Short stroke with high flow.
3. The patented solenoid develops high shifting forces.
4. Powerful return spring.
5. Manual operator standard on all valves.
6. Direct solenoid operated.

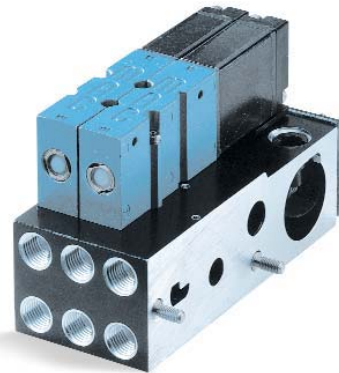

HOW TO ORDER

47A-xxx-HxxP-xxx

HOW TO ORDER VALVE FOR "PLUG-IN" CIRCUIT BAR

	Valve
Valve less base	 <input type="radio"/> 47A-LI0-HxxP-xxx

SOLENOID OPERATOR >

H XX P- X XX*

XX	Voltage	X	Manual operator	XX	Electrical connection
<input type="radio"/> DA	24VDC (5.2 W)	<input type="radio"/> 1	Non-locking	<input type="radio"/> FA	Plug-in
<input type="radio"/> DB	24VDC (2.4 W)			<input type="radio"/> FC	Plug-in with light
<input type="radio"/> DC	24VDC (1.8 W)			<input type="radio"/> FE	Plug-in with suppression diode
<input type="radio"/> DD	24VDC (1.0 W)			<input type="radio"/> FG	Plug-in with suppression diode with LED light
<input type="radio"/> AA	120VAC (Mod. No. required see below)			<input type="radio"/> xx	Other Options
<input type="radio"/> xx	Other Options				

HOW TO ORDER "PLUG-IN" CIRCUIT BAR

ECD47A-xxxxx-xxxx

Port size	Spacing mm	Side cylinder ports	Bottom cylinder ports
1/8" NPTF	18	<input type="radio"/> ECD47A-00ACA-A0xx	<input type="radio"/> ECD47A-00BCA-A0xx
1/4" NPTF	18	<input type="radio"/> ECD47A-00ACB-A0xx	<input type="radio"/> ECD47A-00BCB-A0xx
6 mm tube receptacle	18	<input type="radio"/> ECD47A-00ACG-A0xx	<input type="radio"/> ECD47A-00BCG-A0xx
1/8" NPTF	30	<input type="radio"/> ECD47A-01ACA-C0xx	<input type="radio"/> ECD47A-01BCA-C0xx
1/4" NPTF	30	<input type="radio"/> ECD47A-01ACB-C0xx	<input type="radio"/> ECD47A-01BCB-C0xx
6 mm tube receptacle	30	<input type="radio"/> ECD47A-01ACG-C0xx	<input type="radio"/> ECD47A-01BCG-C0xx

Number of stations (01=1 station). Maximum length is 4 stations
 Note: clic for valves mounted on base at the factory (add - 9 to the model number).
 when add-a-unit stations are added to bars with a multi-pin connector,
 MOD SD03 should be included with add-a-unit model number.
 for AC voltage use mod. FWR2 after circuit bar model number.

- A0 = without light
- AA = with light (120V)
- AB = with light (240V)
- AD = with light (24V)
- C0 = terminal strip
- CA = terminal strip with light (120V)
- CB = terminal strip with light (240V)
- CD = terminal strip with light (24V)

**TECHNICAL
DATA**

Fluid :	Compressed air, vacuum, inert gases
Pressure range :	Vacuum to 120 PSI
Lubrication :	Not required, if used select a medium aniline point lubricant (between 180°F and 210°F)
Filtration :	40 µ
Temperature range :	0°F to 120°F (-18°C to 50°C)
Orifice :	4.3 mm
Flow (at 6 bar, ΔP=1bar) :	5.2 W : 0.50C _v , 2.4 W : 0.30C _v , 1.8 W : 0.25C _v , 1.0 W : 0.25C _v
Coil :	General purpose class A, continuous duty, encapsulated
Voltage range :	-15% to +10% of nominal voltage
Power :	5.2 W - 2.4 W - 1.8 W - 1.0 W
Response times :	Energize : 14.0 ms
(with 5.2 W coil)	De-energize : 5.0 ms

- Note : • Valve and coil are not interchangeable.
- Spare parts : • Seal between valve and bar : 16629. • Mounting screw (x2) : 35043. • Valve blanking plate : M-47001.
• O-ring port seal (x3) : 17015-01 • Tie rod (x2) : 79007-01 (one station length).
- Options : • Isolation of inlet and/or exhaust. Special bar. Consult factory. • BSPP Threads.

DIMENSIONS

Number of stations	1	2	3	4	5	6	7	8	9	10
"G"	-	51.85	69.85	87.85	105.85	123.85	141.85	159.85	177.85	195.85
"H"	21.70	39.70	57.70	75.70	-	-	-	-	-	-

Dimensions are based on 18 mm centerline spacing
Note: Bottom & side cylinder ports not available on the same station

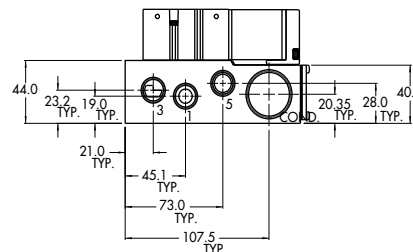
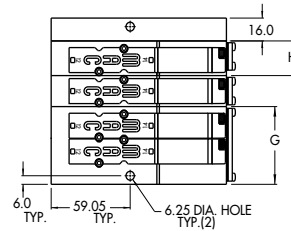
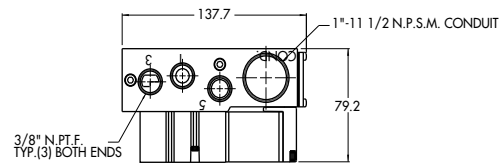
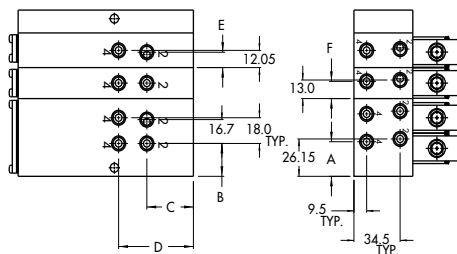

Dim.	1/8"	1/4"	6 mm Legris
"A"	24.20	24.20	25.65
"B"	23.00	23.00	23.00
"C"	34.80	33.10	34.80
"D"	55.90	58.40	55.90
"E"	-	-	-
"F"	12.05	12.00	14.00

Function	Port size	Flow [Max]	Circuit bar mounting
5/2	1/8" - 1/4"	0.5C_v	plug-in add-a-unit stations with Pr. Reg.

OPERATIONAL BENEFITS

1. Balanced poppet, immune to variations of pressure.
2. Short stroke with high flow.
3. The patented solenoid develops high shifting forces.
4. Powerful return spring.
5. Manual operator standard on all valves.
6. Direct solenoid operated.



HOW TO ORDER

47A-xxx-HxxP-xxx

HOW TO ORDER VALVE FOR "PLUG-IN" CIRCUIT BAR

Valve less base	Valve
	<input type="radio"/> 47A-LI0-HxxP-xxx

SOLENOID OPERATOR >

H XX P- X XX'		
XX Voltage	X Manual operator	XX Electrical connection
<input type="radio"/> DA 24VDC (5.2 W)	<input type="radio"/> 1 Non-locking	<input type="radio"/> FA Plug-in
<input type="radio"/> DB 24VDC (2.4 W)		<input type="radio"/> FC Plug-in with light
<input type="radio"/> DC 24VDC (1.8 W)		<input type="radio"/> FE Plug-in with suppression diode
<input type="radio"/> DD 24VDC (1.0 W)		<input type="radio"/> FG Plug-in with suppression diode with LED light
<input type="radio"/> AA 120VAC (Mod. No. required see below)		<input type="radio"/> xx Other Options
<input type="radio"/> xx Other Options		

HOW TO ORDER "PLUG-IN" CIRCUIT BAR (REGULATORS ORDERED SEPARATELY)**

ECD47A-xxxxx-xxxx

Port size	Spacing mm	Bottom cylinder ports
1/8" NPTF	18	<input type="radio"/> ECD47A-00CCA-A0xx
1/4" NPTF	18	<input type="radio"/> ECD47A-00CCB-A0xx
1/8" NPTF	30	<input type="radio"/> ECD47A-01CCA-C0xx
1/4" NPTF	30	<input type="radio"/> ECD47A-01CCB-C0xx

Number of stations (01=1 station). Maximum length is 4 stations .
 Note : clic for valves mounted on base at the factory (add - 9 to the model number),
 when add-a-unit stations are added to bars with a multi-pin connector,
 MOD SD03 should be included with add-a-unit model number.
 for AC voltage use mod. FWR2 after circuit bar model number.

** Pressure Regulators :

PR47A-GOAx

- X=A (0 to 120 PSI)
- X=B (0 to 80 PSI)
- X=C (0 to 30 PSI)
- A0 = without light
- AA = with light (120V)
- AB = with light (240V)
- AD = with light (24V)
- C0 = terminal strip
- CA = terminal strip with light (120V)
- CB = terminal strip with light (240V)
- CD = terminal strip with light (24V)

**TECHNICAL
DATA**

Fluid :	Compressed air, vacuum, inert gases
Pressure range :	Vacuum to 120 PSI
Lubrication :	Not required, if used select a medium aniline point lubricant (between 180°F and 210°F)
Filtration :	40 µ
Temperature range :	0°F to 120°F (-18°C to 50°C)
Orifice :	4.3 mm
Flow (at 6 bar, ΔP=1bar) :	5.2 W : 0.50C _v , 2.4 W : 0.30C _v , 1.8 W : 0.25C _v , 1.0 W : 0.25C _v
Coil :	General purpose class A, continuous duty, encapsulated
Voltage range :	-15% to +10% of nominal voltage
Power :	5.2 W - 2.4 W - 1.8 W - 1.0 W
Response times :	Energize : 14.0 ms
(with 5.2 W coil)	De-energize : 5.0 ms

- Note : • Valve and coil are not interchangeable.
- Spare parts : • Seal between valve and bar : 16629. • Mounting screw (x2) : 35043. • Valve blanking plate : M-47001. • O-ring port seal (x3) : 17015-01 • Tie rod (x2) : 79007-01 (one station length). • Regulator blanking plate : R-47003.
- Options : • Isolation of inlet and/or exhaust. Special bar. Consult factory. • BSPP Threads.

DIMENSIONS

Number of stations	1	2	3	4	5	6	7	8	9	10
"G" w/regulator	54.40	72.40	90.40	108.40	126.40	144.40	162.40	180.40	199.40	
"G" w/o regulator	51.85	69.85	87.85	105.85	123.85	141.85	159.85	177.85	195.85	
"H" w/regulator	24.25	42.25	60.25	78.25	-	-	-	-	-	-
"H" w/o regulator	21.70	39.70	57.70	75.70	-	-	-	-	-	-

Dimensions are based on 18 mm centerline spacing

Note: Bottom & side cylinder ports not available on the same station

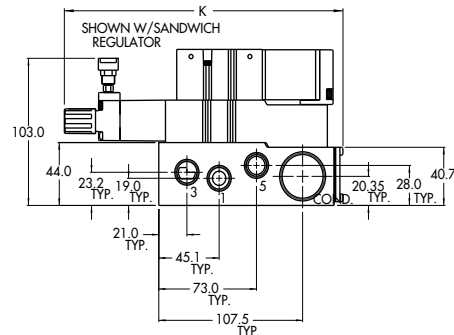
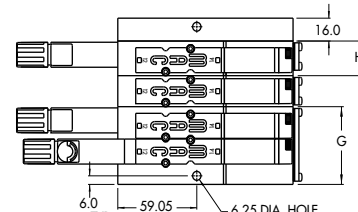
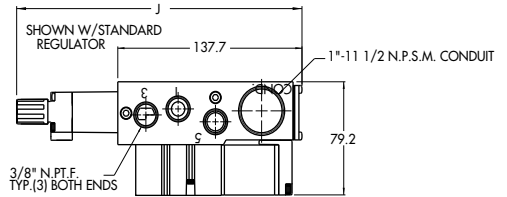
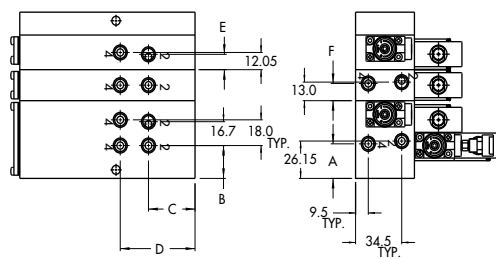

Dim.	1/8"	1/4"	6 mm Legris	1/8" w/regulator	1/4" w/regulator
"A"	24.20	24.20	25.65	-	-
"B"	23.00	23.00	23.00	-	23.00
"C"	34.80	33.10	34.80	34.80	33.10
"D"	55.90	58.40	55.90	55.90	58.40
"E"	-	-	-	10.75	10.85
"F"	12.05	12.00	14.00	-	-

Dim.	Regulator with locking adjusting screw	Regulator with adjusting screw	Regulator with adjusting knob
"J"	209.3	205.1	212.1
"K"	204.3	200.1	207.1



Section 2

Options



0 p t i o n s

Codification table for voltages / Wire length / Manual operators / Electrical connections

VALVE CODE ➤

-HXX X - X XX
1 2 3 4

OPTIONS AVAILABLE FOR

- Solenoid valves 37 & 47 Series

1. VOLTAGE

- H XX	X - X XX	VOLTAGE
DC Options		
<input type="radio"/>	DA	24 VDC (5.2 W)
<input type="radio"/>	DB	24 VDC (2.4 W)
<input type="radio"/>	DC	24 VDC (1.8 W)
<input type="radio"/>	DD	24 VDC (1.0 W)
<input type="radio"/>	DF	12 VDC (5.2 W)
<input type="radio"/>	DG	12 VDC (2.4 W)
<input type="radio"/>	DH	12 VDC (1.8 W)
<input type="radio"/>	DJ	12 VDC (1.0 W)
<input type="radio"/>	DL	120 VDC (6.3 W)
AC Options (50/60hz)		
<input type="radio"/>	AA	120 VAC (6.7 W)
<input type="radio"/>	AB	220 VAC (5.6 W)
<input type="radio"/>	AC	240 VAC (5.8 W)
<input type="radio"/>	AD	24 VAC (7.8 W)

Note : AC Voltages only available with "H" & "F" type connectors. MOD FWR2 must be used with the "F" type connectors.

2. WIRE LENGTH

- H XX	X - X XX	WIRE LENGTH
<input type="radio"/>	O	No lead wire
<input type="radio"/>	A	18"
<input type="radio"/>	B	24"
<input type="radio"/>	C	36"
<input type="radio"/>	D	48"
<input type="radio"/>	E	72"
<input type="radio"/>	F	96"
<input type="radio"/>	G	120"
<input type="radio"/>	H	144"
<input type="radio"/>	P	Plug-in (used only with "F" type connector Opts.)

Use "O" with MJ & MM Opts.

3. MANUAL OPERATOR

- H XX	X - X XX	MANUAL OPERATOR
<input type="radio"/>	0	No operator
<input type="radio"/>	1	Non-locking recessed
<input type="radio"/>	2	Locking recessed
<input type="radio"/>	3	Non-locking extended
<input type="radio"/>	4	Locking extended



4. ELECTRICAL CONNECTION

- H XX	X - X XX	ELECTRICAL CONNECTION
<input type="radio"/>	BA	Flying leads
<input type="radio"/>	BB	Flying leads with ground wire
<input type="radio"/>	BC	Flying leads with led light
<input type="radio"/>	BD	Flying leads with led light & ground wire
<input type="radio"/>	BE	Flying leads with suppression diode
<input type="radio"/>	BF	Flying leads with suppression diode & ground wire
<input type="radio"/>	BG	Flying leads with suppression diode plus led light
<input type="radio"/>	BH	Flying leads with suppression diode plus led light & ground wire
<input type="radio"/>	*BN	Flying leads with suppression diode plus blocking diode
<input type="radio"/>	*BP	Flying leads with suppression diode plus blocking diode & ground wire
<input type="radio"/>	*BR	Flying leads with suppression diode plus blocking diode & led light
<input type="radio"/>	*BS	Flying leads with suppression diode plus blocking diode & led light & ground wire
<input type="radio"/>	FA	Plug-in
<input type="radio"/>	FB	Plug-in with ground wire
<input type="radio"/>	FC	Plug-in with led light
<input type="radio"/>	FD	Plug-in with led light & ground wire
<input type="radio"/>	FE	Plug-in with suppression diode
<input type="radio"/>	FF	Plug-in with suppression diode & ground wire
<input type="radio"/>	FG	Plug-in with suppression diode plus led light
<input type="radio"/>	FH	Plug-in with suppression diode plus led light & ground wire
		Note : FA ---- FH options for use with ECD type circuit bars
<input type="radio"/>	HA	Circuit board plug-in with full wave rectifier & led light
<input type="radio"/>	HB	Circuit board with full wave rectifier & led with ground wire
<input type="radio"/>	HC	Same as "HA" without lead wires
<input type="radio"/>	HD	Same as "HB" without lead wires
<input type="radio"/>	HL	Circuit board plug-in with suppression diode plus blocking diode & led light
<input type="radio"/>	HN	Same as "HL" without lead wires
<input type="radio"/>	MA	Plug-in wire assembly
<input type="radio"/>	MB	Plug-in wire assembly with ground wire
<input type="radio"/>	MC	Plug-in wire assembly with led light
<input type="radio"/>	MD	Plug-in wire assembly led light & ground wire
<input type="radio"/>	ME	Plug-in wire assembly with suppression diode
<input type="radio"/>	MF	Plug-in wire assembly with suppression diode & ground wire
<input type="radio"/>	*MG	Plug-in wire assembly suppression diode plus led light
<input type="radio"/>	*MH	Plug-in wire assembly suppression diode plus led light & ground wire
<input type="radio"/>	*MN	Plug-in wire assembly with suppression diode plus blocking diode
<input type="radio"/>	*MP	Plug-in wire assembly with suppression diode plus blocking diode & ground wire
<input type="radio"/>	MR	Plug-in wire assembly with suppression diode plus blocking diode & led light
<input type="radio"/>	MS	Plug-in wire assembly with suppression diode plus blocking diode & led light & ground wire
<input type="radio"/>	MJ	Plug-in housing w/o wire assembly ("MA" option without wire assembly)
<input type="radio"/>	MM	Plug-in housing w/o wire assembly ("MB" option without wire assembly)

* Blocking diode is in lead wire.

MOD. S009

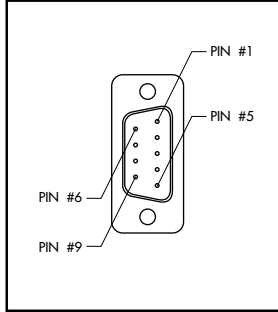

TECHNICAL DATA

- Type «SUB_D»
- Number of contacts : 9
- Solder termination (Dia. 0.6 mm/0.14 mm²/26-22 AWG)
- Operating current 5 A/contact
- Rated voltage 125 V~
- Temp. range -40° to +125°C
- Insulation resistance ≥ 5.0⁹ Ω
- Protection class IP40 (DIN 40050)
- Number of solenoids : 7 max.
- Max. 24 V=/5.4 W per solenoid
- 2 common wires

MOD. S015

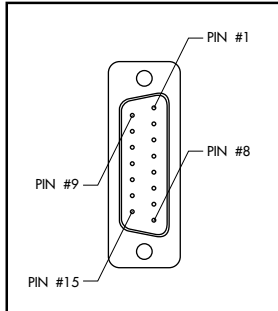

TECHNICAL DATA

- Type «SUB_D»
- Number of contacts : 15
- Solder termination (Dia. 0.6 mm/0.14 mm²/26-22 AWG)
- Operating current 5 A/contact
- Rated voltage 125 V~
- Temp. range -40° to +125°C
- Insulation resistance ≥ 5.0⁹ Ω
- Protection class IP40 (DIN 40050)
- Number of solenoids : 12 max.
- Max. 24 V=/5.4 W per solenoid
- 3 common wires

MOD. S025

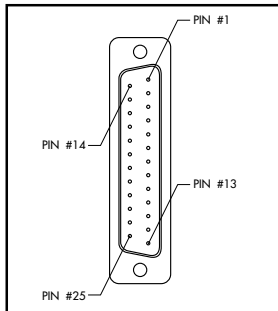

TECHNICAL DATA

- Type «SUB_D»
- Number of contacts : 25
- Solder termination (Dia. 0.6 mm/0.14 mm²/26-22 AWG)
- Operating current 5 A/contact
- Rated voltage 125 V~
- Temp. range -40° to +125°C
- Insulation resistance ≥ 5.0⁹ Ω
- Protection class IP40 (DIN 40050)
- Number of solenoids : 20 max.
- Max. 24 V=/5.4 W per solenoid
- 5 common wires

Note : Use desired MOD. number after circuit bar part number

Connector termination details

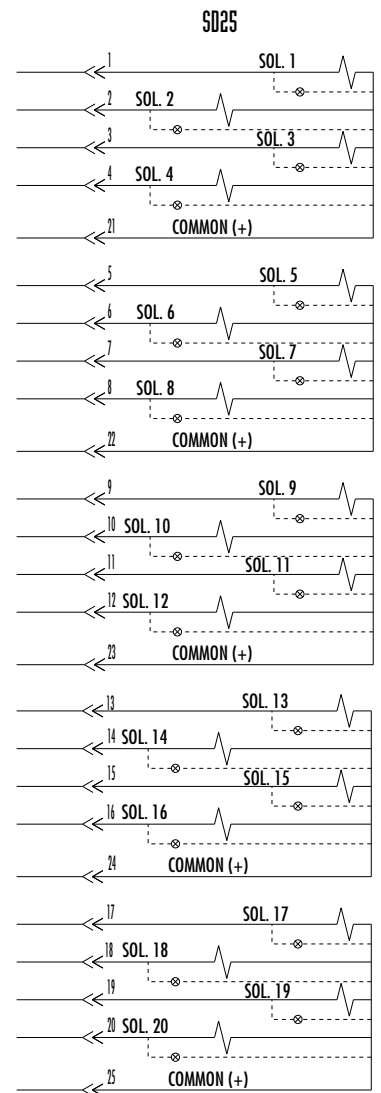
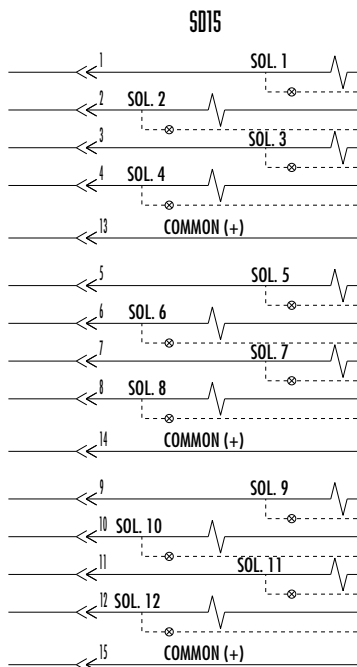
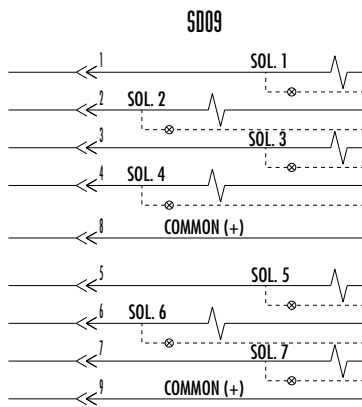
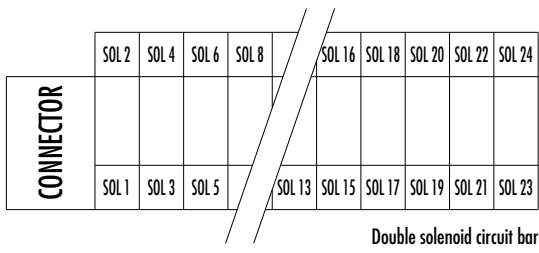
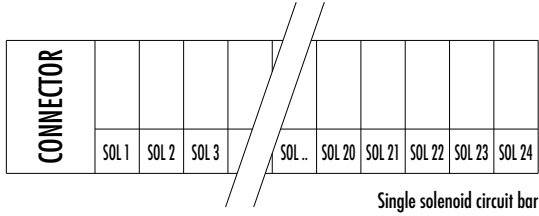

Circuit bar mounting

low profile cylinder ports in valve	low profile cylinder ports in base	mid profile cylinder ports in valve	mid profile - add on style cylinder ports in valve	add-a-unit stations for CBM403A bar	mid profile cylinder ports in base	mid profile - add on style cylinder ports in base	add-a-unit stations for CBM404A bar
	high profile cylinder ports in base	high profile - add on style cylinder ports in base					add-a-unit stations for CBM405A bar

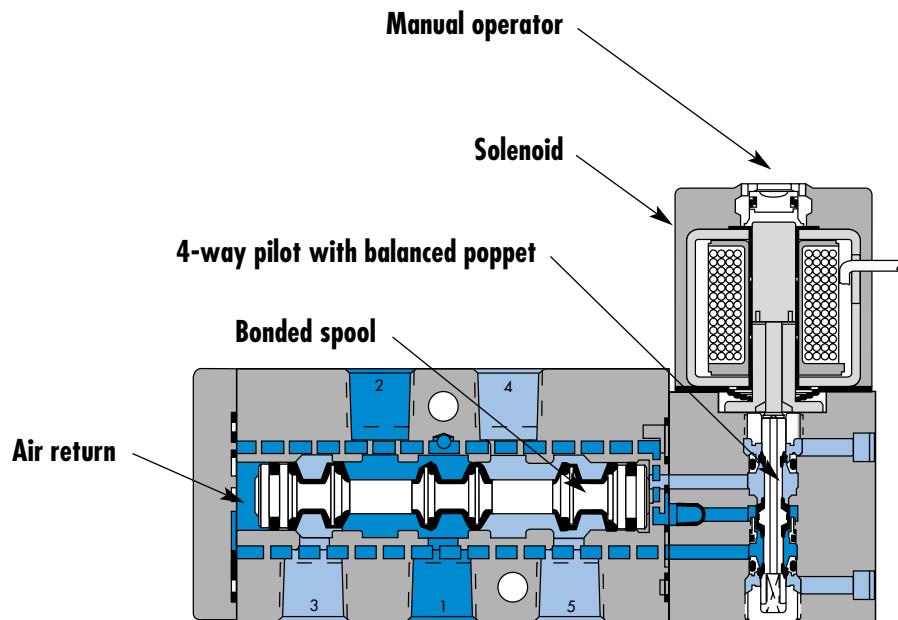

SERIES FEATURES

- Patented MACSOLENOID® for fastest possible response times and virtually burn-out proof AC solenoid operation.
- Optional low watt DC solenoids.
- Various manual operators.
- Optional memory spring.
- 2 position or 3 position valve configurations.
- Internal or external pilot.

Function	Port size (NPTF)	Flow (Max)	Circuit bar mounting
5/2 - 5/3	1/8" - 1/4"	1.0C_v	low profile cylinder ports in valve

OPERATIONAL BENEFITS

1. The 4-way pilot develops maximum shifting forces both ways.
2. Memory spring available.
3. Balanced spool, immune to variations of pressure, also provides high flow.
4. Short stroke with high flow.
5. Bonded spool with minimum friction, shifting in a glass-like finished bore.
6. Pilot with balanced poppet, high flow, short and consistent response times.
7. Wiping effect eliminates sticking.
8. Long service life.

Reset



HOW TO ORDER

xxxx-xxx-DM-Dxxx-xxx

HOW TO ORDER VALVE FOR CIRCUIT BAR MOUNTING

Port size	Pilot air	5/2 Single operator	5/2 Double operator	5/3 Closed center	5/3 Open center	5/3 Pressure center
1/8" NPT	Internal	<input type="radio"/> 411A-AOA-DM-Dxxx-xxx	<input type="radio"/> 421A-AOA-DM-Dxxx-xxx	<input type="radio"/> 451A-AOA-DM-Dxxx-xxx	<input type="radio"/> 461A-AOA-DM-Dxxx-xxx	<input type="radio"/> 471A-AOA-DM-Dxxx-xxx
1/4" NPT		<input type="radio"/> 411A-BOA-DM-Dxxx-xxx	<input type="radio"/> 421A-BOA-DM-Dxxx-xxx	<input type="radio"/> 451A-BOA-DM-Dxxx-xxx	<input type="radio"/> 461A-BOA-DM-Dxxx-xxx	<input type="radio"/> 471A-BOA-DM-Dxxx-xxx

SOLENOID OPERATOR >

D XX X- X XX*

XX Voltage	X Wire length	X Manual operator	XX Electrical connection
<input type="radio"/> JB 240/60, 220/50	<input type="radio"/> A 18" (Flying leads)	<input type="radio"/> 1 Non-locking	<input type="radio"/> KA Square connector
<input type="radio"/> JA 120/60, 110/50	<input type="radio"/> J Connector	<input type="radio"/> 2 Locking	<input type="radio"/> KD Square connector with light
<input type="radio"/> JC 24/60, 24/50	<input type="radio"/> x Other Options	<input type="radio"/> x Other Options	<input type="radio"/> JB Rectangular connector
<input type="radio"/> FB 24VDC (1.8 W)			<input type="radio"/> JD Rectangular connector with light
<input type="radio"/> DA 24VDC (5.4 W)			<input type="radio"/> BA Flying leads
<input type="radio"/> DF 24VDC (12.7 W)			<input type="radio"/> xx Other Options
<input type="radio"/> xx Other Options			

HOW TO ORDER CIRCUIT BAR **

CBM401A-xxxxxx-xx

Port size	Pilot air	Spacing standard 19,5 mm		Spacing 26 mm (Rectangular connector)	
		w/o flow controls	w/ flow controls	w/o flow controls	w/ flow controls
3/8" NPTF	Internal	<input type="radio"/> CBM401A-00AAA-xx	<input type="radio"/> CBM401A-00BAA-xx	<input type="radio"/> CBM401A-02AAA-xx	<input type="radio"/> CBM401A-02BAA-xx

Number of stations (03=3 stations)

** Other options available. Consult factory.

OPTIONS

411A-AOA-DM-Dxxx-xxx

- clic with memory spring (replace by 4).

**TECHNICAL
DATA**

Fluid :	Compressed air, vacuum, inert gases		
Pressure range :	20 - 150 PSI		
Pilot pressure :	20 - 150 PSI		
Lubrication :	Not required, if used select a medium aniline point lubricant (between 180°F to 210°F)		
Filtration :	40 µ		
Temperature range :	0°F to 120°F (-18°C to +50°C)		
Orifice :	6.2 mm		
Flow :	1.0C _v		
Coil :	General purpose class A, continuous duty, encapsulated		
Voltage range :	-15% to +10% of nominal voltage		
Protection :	NEMA 4		
Power :	~ Inrush : 10.9 VA	Holding : 7.7 VA	
	= 1.8 to 12.7 W		
Response times :	24 V= /5.4 W	Energize : 7.3 ms	De-energize : 5.3ms
	60Hz/6 W	Energize : 8-12 ms	De-energize : 7-11 ms

- Spare parts : • Pilot valve : DMB-DXXX-XXX-1, including mounting screws 35069 and seal 16524.
- Accessories : • Blanking plate : M-04001. • Flow control (x2) : N-04001. • Seal (x2) : 17013-01, (x1) : 17015-01. • Mounting screw (x2) : 35043.
- Options : • BSPP threads. • Isolation of inlet and/or exhaust.

DIMENSIONS

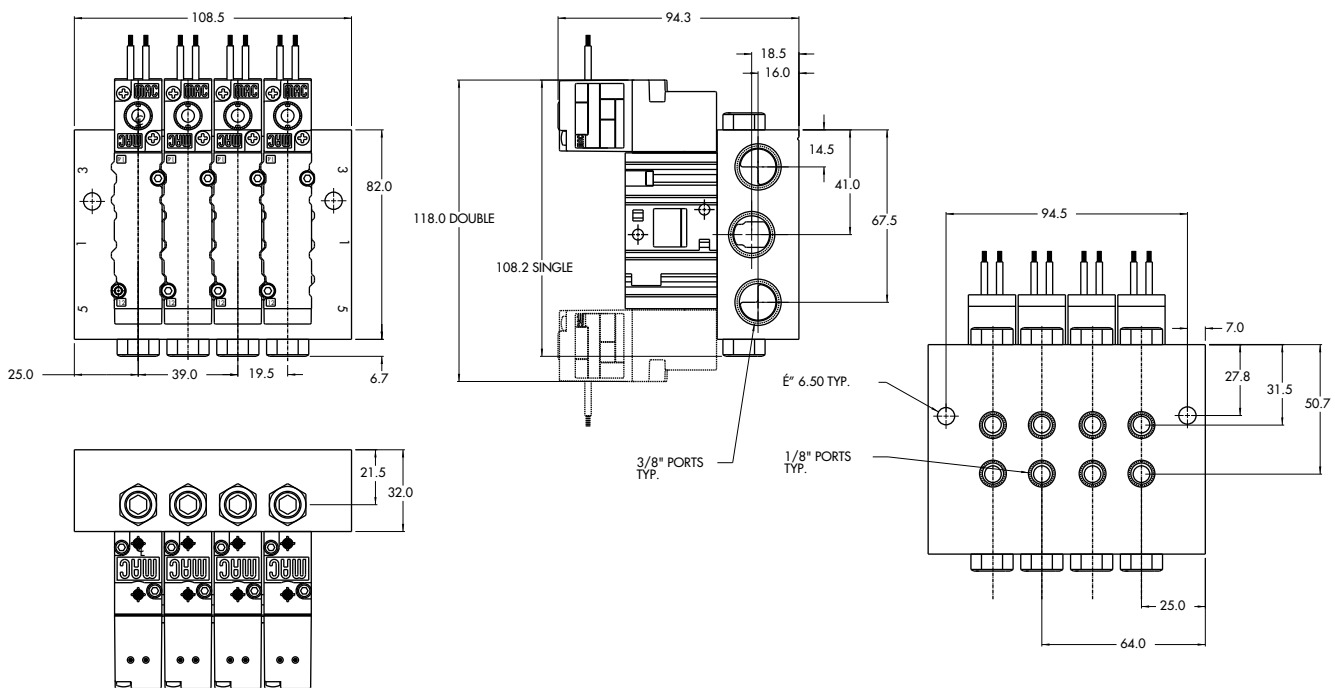

Function	Port size (NPTF)	Flow [Max]	Circuit bar mounting
5/2 - 5/3	1/8"	1.0C_v	low profile cylinder ports in base

OPERATIONAL BENEFITS

1. The 4-way pilot develops maximum shifting forces both ways.
2. Memory spring available.
3. Balanced spool, immune to variations of pressure, also provides high flow.
4. Short stroke with high flow.
5. Bonded spool with minimum friction, shifting in a glass-like finished bore.
6. Pilot with balanced poppet, high flow, short and consistent response times.
7. Wiping effect eliminates sticking.
8. Long service life.

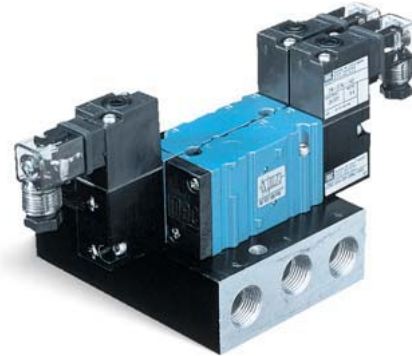

HOW TO ORDER

xxxx-xxx-DM-Dxxx-xxx

HOW TO ORDER VALVE FOR CIRCUIT BAR MOUNTING

Pilot air	5/2 Single operator	5/2 Double operator	5/3 Closed center	5/3 Open center	5/3 Pressure center
Internal	<input type="radio"/> 413A-OOA-DM-Dxxx-xxx	<input type="radio"/> 423A-OOA-DM-Dxxx-xxx	<input type="radio"/> 453A-OOA-DM-Dxxx-xxx	<input type="radio"/> 463A-OOA-DM-Dxxx-xxx	<input type="radio"/> 473A-OOA-DM-Dxxx-xxx

SOLENOID OPERATOR >

D XX X- X XX'

XX Voltage	X Wire length	X Manual operator	XX Electrical connection
<input type="radio"/> JB 240/60, 220/50	<input type="radio"/> A 18" (Flying leads)	<input type="radio"/> 1 Non-locking	<input type="radio"/> KA Square connector
<input type="radio"/> JA 120/60, 110/50	<input type="radio"/> J Connector	<input type="radio"/> 2 Locking	<input type="radio"/> KD Square connector with light
<input type="radio"/> JC 24/60, 24/50	<input type="radio"/> x Other Options	<input type="radio"/> x Other Options	<input type="radio"/> JB Rectangular connector
<input type="radio"/> FB 24VDC (1.8 W)			<input type="radio"/> JD Rectangular connector with light
<input type="radio"/> DA 24VDC (5.4 W)			<input type="radio"/> BA Flying leads
<input type="radio"/> DF 24VDC (12.7 W)			<input type="radio"/> xx Other Options
<input type="radio"/> xx Other Options			

CBM402A-xxxxx-xx

HOW TO ORDER CIRCUIT BAR (BOTTOM CYLINDER PORTS) **

Port size	Pilot air	Spacing standard 19,5 mm		Spacing 26 mm (Rectangular connector)	
		w/o flow controls	w/ flow controls	w/o flow controls	w/ flow controls
1/8" NPTF	Internal	<input type="radio"/> CBM402A-00AAA-xx	<input type="radio"/> CBM402A-00BAA-xx	<input type="radio"/> CBM402A-02AAA-xx	<input type="radio"/> CBM402A-02BAA-xx

Number of stations (03=3 stations)
 ** Other options available. Consult factory.

OPTIONS

413A-OOA-DM-Dxxx-xxx
 clic with memory spring (replace by 6).

**TECHNICAL
DATA**

Fluid :	Compressed air, vacuum, inert gases		
Pressure range :	20 - 150 PSI		
Pilot pressure :	20 - 150 PSI		
Lubrication :	Not required, if used select a medium aniline point lubricant (between 180°F to 210°F)		
Filtration :	40 µ		
Temperature range :	0°F to 120°F (-18°C to +50°C)		
Orifice :	6.2 mm		
Flow :	1.0C _v		
Coil :	General purpose class A, continuous duty, encapsulated		
Voltage range :	-15% to +10% of nominal voltage		
Protection :	NEMA 4		
Power :	~ Inrush : 10.9 VA	Holding : 7.7 VA	
	= 1.8 to 12.7 W		
Response times :	24 V= /5.4 W	Energize : 7.3 ms	De-energize : 5.3ms
	60Hz/6 W	Energize : 8-12 ms	De-energize : 7-11 ms

Spare parts : • Pilot valve : DMB-DXXX-XXX-1, including mounting screws 35069 and seal 16524.

Accessories : • Blanking plate : M-04002. • Flow control (x2) : N-04001. • Seal : 16525.
• Mounting screw (x2) : 35043.

Options : • BSPP threads. • Isolation of inlet and/or exhaust.

DIMENSIONS

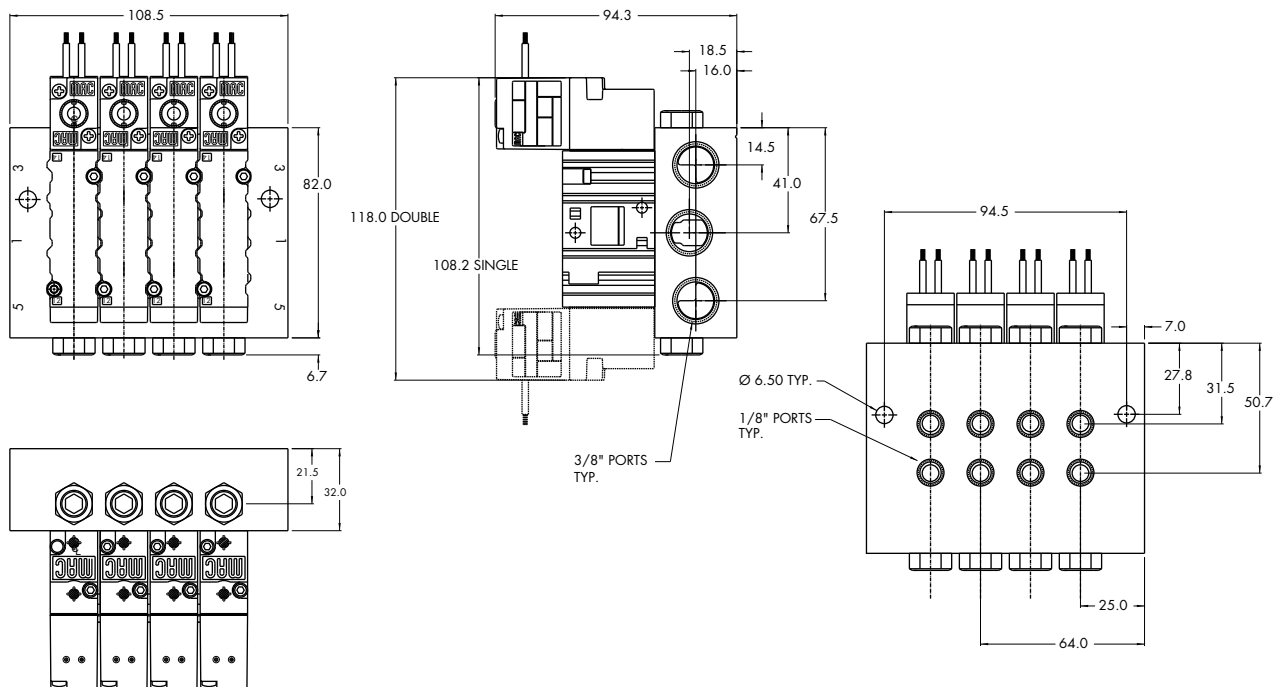

Function	Port size (NPTF)	Flow [Max]	Circuit bar mounting
5/2 - 5/3	1/8" - 1/4"	1.0C_v	mid profile cylinder ports in valve

OPERATIONAL BENEFITS

1. The 4-way pilot develops maximum shifting forces both ways.
2. Memory spring available.
3. Balanced spool, immune to variations of pressure, also provides high flow.
4. Short stroke with high flow.
5. Bonded spool with minimum friction, shifting in a glass-like finished bore.
6. Pilot with balanced poppet, high flow, short and consistent response times.
7. Wiping effect eliminates sticking.
8. Long service life.



HOW TO ORDER

xxxx-xxx-DM-Dxxx-xxx

HOW TO ORDER VALVE FOR CIRCUIT BAR MOUNTING

Port size	Pilot air	5/2 Single operator	5/2 Double operator	5/3 Closed center	5/3 Open center	5/3 Pressure center
1/8" NPT	Internal	<input type="radio"/> 411A-AOA-DM-Dxxx-xxx	<input type="radio"/> 421A-AOA-DM-Dxxx-xxx	<input type="radio"/> 451A-AOA-DM-Dxxx-xxx	<input type="radio"/> 461A-AOA-DM-Dxxx-xxx	<input type="radio"/> 471A-AOA-DM-Dxxx-xxx
1/4" NPT	Internal	<input type="radio"/> 411A-BOA-DM-Dxxx-xxx	<input type="radio"/> 421A-BOA-DM-Dxxx-xxx	<input type="radio"/> 451A-BOA-DM-Dxxx-xxx	<input type="radio"/> 461A-BOA-DM-Dxxx-xxx	<input type="radio"/> 471A-BOA-DM-Dxxx-xxx
1/8" NPT	External	<input type="radio"/> 411A-AOD-DM-Dxxx-xxx	<input type="radio"/> 421A-AOD-DM-Dxxx-xxx	<input type="radio"/> 451A-AOD-DM-Dxxx-xxx	<input type="radio"/> 461A-AOD-DM-Dxxx-xxx	<input type="radio"/> 471A-AOD-DM-Dxxx-xxx
1/4" NPT	External	<input type="radio"/> 411A-BOD-DM-Dxxx-xxx	<input type="radio"/> 421A-BOD-DM-Dxxx-xxx	<input type="radio"/> 451A-BOD-DM-Dxxx-xxx	<input type="radio"/> 461A-BOD-DM-Dxxx-xxx	<input type="radio"/> 471A-BOD-DM-Dxxx-xxx

SOLENOID OPERATOR >

D **XX X- X XX***

XX Voltage	X Wire length	X Manual operator	XX Electrical connection
<input type="radio"/> JB 240/60, 220/50	<input type="radio"/> A 18" (Flying leads)	<input type="radio"/> 1 Non-locking	<input type="radio"/> KA Square connector
<input type="radio"/> JA 120/60, 110/50	<input type="radio"/> J Connector	<input type="radio"/> 2 Locking	<input type="radio"/> KD Square connector with light
<input type="radio"/> JC 24/60, 24/50	<input type="radio"/> x Other Options	<input type="radio"/> x Other Options	<input type="radio"/> JB Rectangular connector
<input type="radio"/> FB 24VDC (1.8 W)			<input type="radio"/> JD Rectangular connector with light
<input type="radio"/> DA 24VDC (5.4 W)			<input type="radio"/> BA Flying leads
<input type="radio"/> DF 24VDC (12.7 W)			<input type="radio"/> xx Other Options
<input type="radio"/> xx Other Options			

CBM403A-xxxxx-xx

HOW TO ORDER CIRCUIT BAR **

Port size	Pilot air	Spacing standard 19,5 mm		Spacing 26 mm (Rectangular connector)	
		w/o flow controls	w/ flow controls	w/o flow controls	w/ flow controls
3/8" NPTF	Internal	<input type="radio"/> CBM403A-00AAA-xx	<input type="radio"/> CBM403A-00BAA-xx	<input type="radio"/> CBM403A-02AAA-xx	<input type="radio"/> CBM403A-02BAA-xx
	Common external	<input type="radio"/> CBM403A-00CAA-xx	<input type="radio"/> CBM403A-00DAA-xx	<input type="radio"/> CBM403A-02CAA-xx	<input type="radio"/> CBM403A-02DAA-xx

Number of stations (03=3 stations)
 ** Other options available. Consult factory.

OPTIONS

411A-AOA-DM-Dxxx-xxx clic with memory spring (replace by 4).

**TECHNICAL
DATA**

Fluid :	Compressed air, vacuum, inert gases		
Pressure range :	Internal pilot : 20 - 150 PSI External pilot : vacuum - 150 PSI		
Pilot pressure :	20 - 150 PSI		
Lubrication :	Not required, if used select a medium aniline point lubricant (between 180°F to 210°F)		
Filtration :	40 µ		
Temperature range :	0°F to 120°F (-18°C to +50°C)		
Orifice :	6.2 mm		
Flow :	1.0C _v		
Coil :	General purpose class A, continuous duty, encapsulated		
Voltage range :	-15% to +10% of nominal voltage		
Protection :	NEMA 4		
Power :	~ Inrush : 10.9 VA Holding : 7.7 VA = 1.8 to 12.7 W		
Response times :	24 V=/5.4 W	Energize : 7.3 ms	De-energize : 5.3ms
	60Hz/6 W	Energize : 8-12 ms	De-energize : 7-11 ms

- Spare parts : • Pilot valve : DMB-DXXX-XXX-1, including mounting screws 35069 and seal 16524.
- Accessories : • Blanking plate : M-04001. • Flow control (x2) : N-04001. • Seal (x2) : 17013-01, (x1) : 17015-01.
• Mounting screw (x2) : 35043.
- Options : • BSPP threads. • Isolation of inlet and/or exhaust.

DIMENSIONS

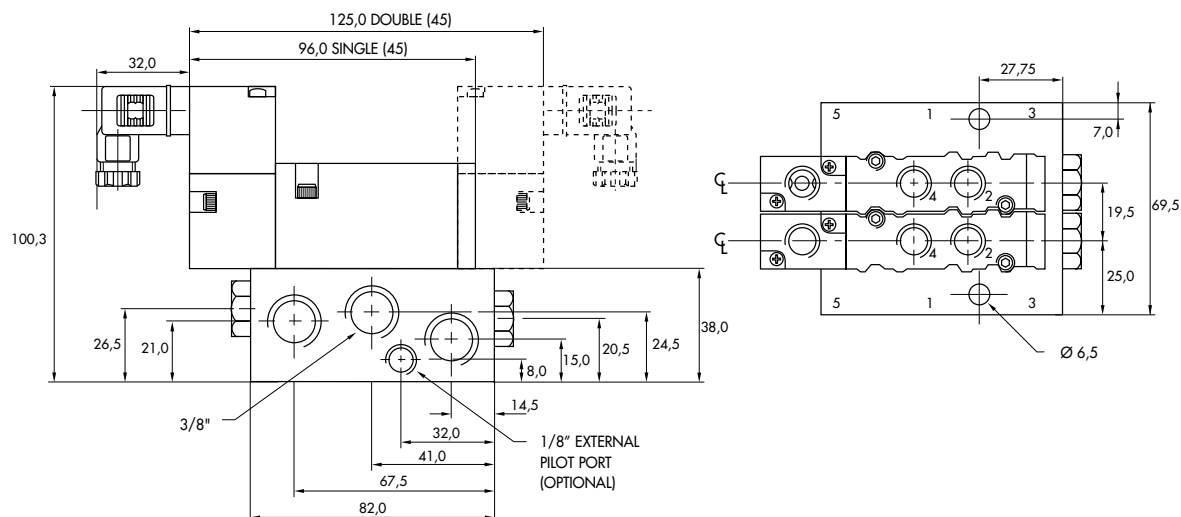

Function	Port size (NPTF)	Flow [Max]	Circuit bar mounting
5/2 - 5/3	1/8" - 1/4"	1.0C_v	mid profile - add on style cylinder ports in valve

OPERATIONAL BENEFITS

1. The 4-way pilot develops maximum shifting forces both ways.
2. Memory spring available.
3. Balanced spool, immune to variations of pressure, also provides high flow.
4. Short stroke with high flow.
5. Bonded spool with minimum friction, shifting in a glass-like finished bore.
6. Pilot with balanced poppet, high flow, short and consistent response times.
7. Wiping effect eliminates sticking.
8. Long service life.

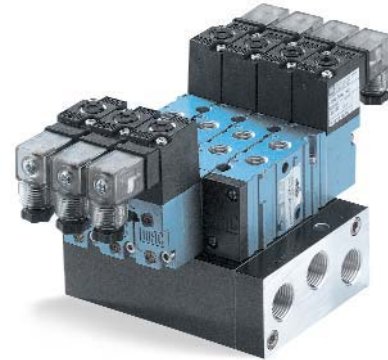

HOW TO ORDER

xxxx-xxx-DM-Dxxx-xxx

HOW TO ORDER VALVE FOR CIRCUIT BAR MOUNTING

Port size	Pilot air	5/2 Single operator	5/2 Double operator	5/3 Closed center	5/3 Open center	5/3 Pressure center
1/8" NPT	Internal	<input type="radio"/> 411A-AOA-DM-Dxxx-xxx	<input type="radio"/> 421A-AOA-DM-Dxxx-xxx	<input type="radio"/> 451A-AOA-DM-Dxxx-xxx	<input type="radio"/> 461A-AOA-DM-Dxxx-xxx	<input type="radio"/> 471A-AOA-DM-Dxxx-xxx
1/4" NPT	Internal	<input type="radio"/> 411A-BOA-DM-Dxxx-xxx	<input type="radio"/> 421A-BOA-DM-Dxxx-xxx	<input type="radio"/> 451A-BOA-DM-Dxxx-xxx	<input type="radio"/> 461A-BOA-DM-Dxxx-xxx	<input type="radio"/> 471A-BOA-DM-Dxxx-xxx
1/8" NPT	External	<input type="radio"/> 411A-AOD-DM-Dxxx-xxx	<input type="radio"/> 421A-AOD-DM-Dxxx-xxx	<input type="radio"/> 451A-AOD-DM-Dxxx-xxx	<input type="radio"/> 461A-AOD-DM-Dxxx-xxx	<input type="radio"/> 471A-AOD-DM-Dxxx-xxx
1/4" NPT	External	<input type="radio"/> 411A-BOD-DM-Dxxx-xxx	<input type="radio"/> 421A-BOD-DM-Dxxx-xxx	<input type="radio"/> 451A-BOD-DM-Dxxx-xxx	<input type="radio"/> 461A-BOD-DM-Dxxx-xxx	<input type="radio"/> 471A-BOD-DM-Dxxx-xxx

SOLENOID OPERATOR >

D XX X- X XX*

XX Voltage	X Wire length	X Manual operator	XX Electrical connection
<input type="radio"/> JB 240/60, 220/50	<input type="radio"/> A 18" (Flying leads)	<input type="radio"/> 1 Non-locking	<input type="radio"/> KA Square connector
<input type="radio"/> JA 120/60, 110/50	<input type="radio"/> J Connector	<input type="radio"/> 2 Locking	<input type="radio"/> KD Square connector with light
<input type="radio"/> JC 24/60, 24/50	<input type="radio"/> x Other Options	<input type="radio"/> x Other Options	<input type="radio"/> JB Rectangular connector
<input type="radio"/> FB 24VDC (1.8 W)			<input type="radio"/> JD Rectangular connector with light
<input type="radio"/> DA 24VDC (5.4 W)			<input type="radio"/> BA Flying leads
<input type="radio"/> DF 24VDC (12.7 W)			<input type="radio"/> xx Other Options
<input type="radio"/> xx Other Options			

CBM403A-xxxxx-xx

HOW TO ORDER CIRCUIT BAR **

Port size	Pilot air	Spacing standard 19,5 mm		Spacing 26 mm (Rectangular connector)	
		w/o flow controls	w/ flow controls	w/o flow controls	w/ flow controls
3/8" NPTF	Internal	<input type="radio"/> CBM403A-00ABA-xx	<input type="radio"/> CBM403A-00BBA-xx	<input type="radio"/> CBM403A-02ABA-xx	<input type="radio"/> CBM403A-02BBA-xx
	Common external	<input type="radio"/> CBM403A-00CBA-xx	<input type="radio"/> CBM403A-00DBA-xx	<input type="radio"/> CBM403A-02CBA-xx	<input type="radio"/> CBM403A-02DBA-xx

Number of stations (03=3 stations)

** Other options available. Consult factory.

Note: add-a-unit stations may be added to above bars.

OPTIONS

411A-AOA-DM-Dxxx-xxx - clic with memory spring (replace by 4).

Function	Port size (NPTF)	Flow (Max)	Circuit bar mounting
5/2 - 5/3	1/8" - 1/4"	1.0C_v	add-a-unit stations for CBM403A bar

OPERATIONAL BENEFITS

1. The 4-way pilot develops maximum shifting forces both ways.
2. Memory spring available.
3. Balanced spool, immune to variations of pressure, also provides high flow.
4. Short stroke with high flow.
5. Bonded spool with minimum friction, shifting in a glass-like finished bore.
6. Pilot with balanced poppet, high flow, short and consistent response times.
7. Wiping effect eliminates sticking.
8. Long service life.



HOW TO ORDER

xxxx-xxx-DM-Dxxx-xxx

HOW TO ORDER VALVE FOR CIRCUIT BAR MOUNTING

Port size	Pilot air	5/2 Single operator	5/2 Double operator	5/3 Closed center	5/3 Open center	5/3 Pressure center
1/8" NPT	Internal	<input type="radio"/> 411A-AOA-DM-Dxxx-xxx	<input type="radio"/> 421A-AOA-DM-Dxxx-xxx	<input type="radio"/> 451A-AOA-DM-Dxxx-xxx	<input type="radio"/> 461A-AOA-DM-Dxxx-xxx	<input type="radio"/> 471A-AOA-DM-Dxxx-xxx
1/4" NPT	Internal	<input type="radio"/> 411A-BOA-DM-Dxxx-xxx	<input type="radio"/> 421A-BOA-DM-Dxxx-xxx	<input type="radio"/> 451A-BOA-DM-Dxxx-xxx	<input type="radio"/> 461A-BOA-DM-Dxxx-xxx	<input type="radio"/> 471A-BOA-DM-Dxxx-xxx
1/8" NPT	External	<input type="radio"/> 411A-AOD-DM-Dxxx-xxx	<input type="radio"/> 421A-AOD-DM-Dxxx-xxx	<input type="radio"/> 451A-AOD-DM-Dxxx-xxx	<input type="radio"/> 461A-AOD-DM-Dxxx-xxx	<input type="radio"/> 471A-AOD-DM-Dxxx-xxx
1/4" NPT	External	<input type="radio"/> 411A-BOD-DM-Dxxx-xxx	<input type="radio"/> 421A-BOD-DM-Dxxx-xxx	<input type="radio"/> 451A-BOD-DM-Dxxx-xxx	<input type="radio"/> 461A-BOD-DM-Dxxx-xxx	<input type="radio"/> 471A-BOD-DM-Dxxx-xxx

SOLENOID OPERATOR >

D XX X- X XX*

XX Voltage	X Wire length	X Manual operator	XX Electrical connection
<input type="radio"/> JB 240/60, 220/50	<input type="radio"/> A 18" (Flying leads)	<input type="radio"/> 1 Non-locking	<input type="radio"/> KA Square connector
<input type="radio"/> JA 120/60, 110/50	<input type="radio"/> J Connector	<input type="radio"/> 2 Locking	<input type="radio"/> KD Square connector with light
<input type="radio"/> JC 24/60, 24/50	<input type="radio"/> x Other Options	<input type="radio"/> x Other Options	<input type="radio"/> JB Rectangular connector
<input type="radio"/> FB 24VDC (1.8 W)			<input type="radio"/> JD Rectangular connector with light
<input type="radio"/> DA 24VDC (5.4 W)			<input type="radio"/> BA Flying leads
<input type="radio"/> DF 24VDC (12.7 W)			<input type="radio"/> xx Other Options
<input type="radio"/> xx Other Options			

CBM403A-xxxxx-xx

HOW TO ORDER CIRCUIT BAR **

Port size	Pilot air	Spacing 21 mm		Spacing 26 mm (Rectangular connector)	
		w/o flow controls	w/ flow controls	w/o flow controls	w/ flow controls
3/8" NPTF	Internal	<input type="radio"/> CBM403A-01AEA-xx	<input type="radio"/> CBM403A-01BEA-xx	<input type="radio"/> CBM403A-02AEA-xx	<input type="radio"/> CBM403A-02BEA-xx
	Common external	<input type="radio"/> CBM403A-01CEA-xx	<input type="radio"/> CBM403A-01DEA-xx	<input type="radio"/> CBM403A-02CEA-xx	<input type="radio"/> CBM403A-02DEA-xx

Number of stations (01, 02, 03, or 04)

** Other options available. Consult factory.

OPTIONS

411A-AOA-DM-Dxxx-xxx
 clic with memory spring (replace by 4).

TECHNICAL DATA

Fluid :	Compressed air, vacuum, inert gases		
Pressure range :	Internal pilot : 20 - 150 PSI External pilot : vacuum - 150 PSI		
Pilot pressure :	20 - 150 PSI		
Lubrication :	Not required, if used select a medium aniline point lubricant (between 180°F to 210°F)		
Filtration :	40 µ		
Temperature range :	0°F to 120°F (-18°C to +50°C)		
Orifice :	6.2 mm		
Flow :	1.0C _v		
Coil :	General purpose class A, continuous duty, encapsulated		
Voltage range :	-15% to +10% of nominal voltage		
Protection :	NEMA 4		
Power :	~ Inrush : 10.9 VA Holding : 7.7 VA = 1.8 to 12.7 W		
Response times :	24 V= / 5.4 W	Energize : 7.3 ms	De-energize : 5.3ms
	60Hz/6 W	Energize : 8-12 ms	De-energize : 7-11 ms

- Spare parts : • Pilot valve : DMB-DXXX-XXX-1, including mounting screws 35069 and seal 16524.
- Accessories : • Blanking plate : M-04001. • Flow control (x2) : N-04001. • Seal (x2) : 17013-01, (x1) : 17015-01.
• Mounting screw (x2) : 35043. • End plate kit : M-04003-01. • End plate kit for common external : M-04004-01.
- Options : • BSPP threads. • Isolation of inlet and/or exhaust.

DIMENSIONS

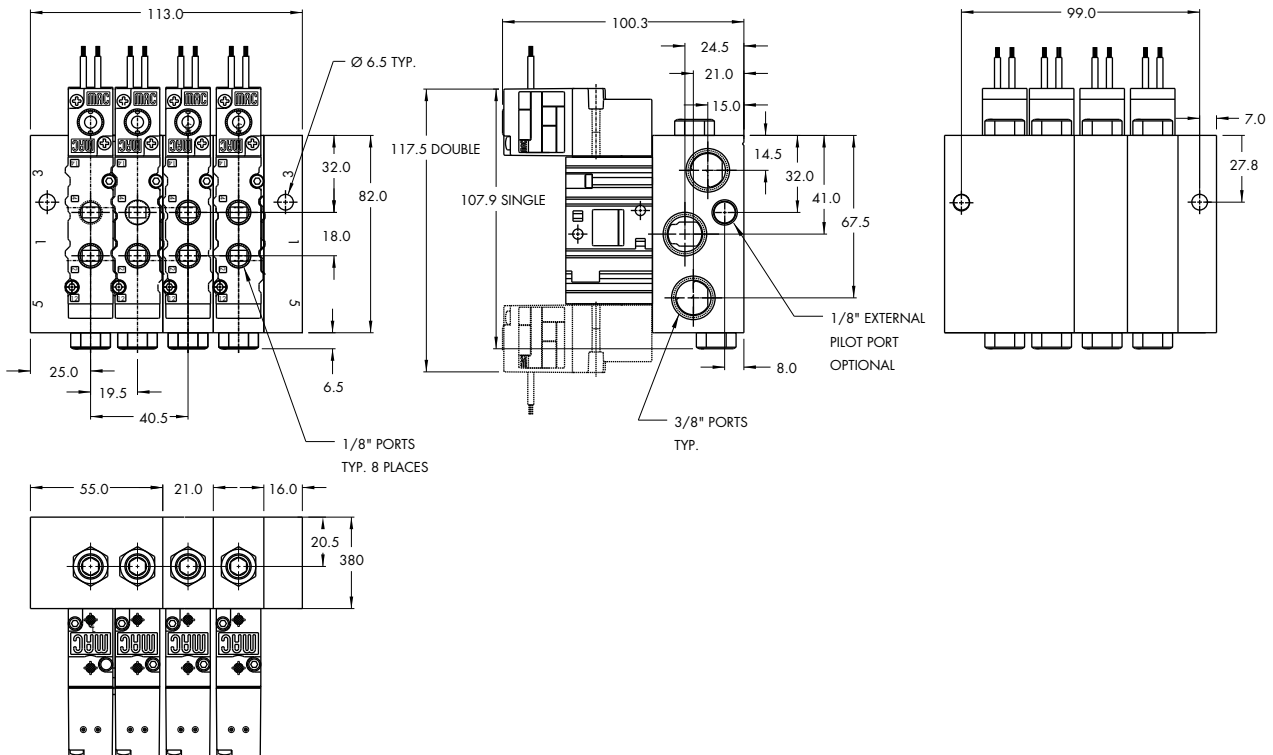

Function	Port size (NPTF)	Flow [Max]	Circuit bar mounting
5/2 - 5/3	1/8" - 1/4"	1.0C_v	mid profile cylinder ports in base

OPERATIONAL BENEFITS

1. The 4-way pilot develops maximum shifting forces both ways.
2. Memory spring available.
3. Balanced spool, immune to variations of pressure, also provides high flow.
4. Short stroke with high flow.
5. Bonded spool with minimum friction, shifting in a glass-like finished bore.
6. Pilot with balanced poppet, high flow, short and consistent response times.
7. Wiping effect eliminates sticking.
8. Long service life.

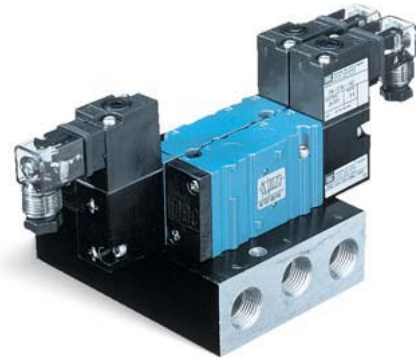

HOW TO ORDER

xxxx-xxx-DM-Dxxx-xxx

HOW TO ORDER VALVE FOR CIRCUIT BAR MOUNTING

Pilot air	5/2 Single operator	5/2 Double operator	5/3 Closed center	5/3 Open center	5/3 Pressure center
Internal	<input type="radio"/> 413A-OOA-DM-Dxxx-xxx	<input type="radio"/> 423A-OOA-DM-Dxxx-xxx	<input type="radio"/> 453A-OOA-DM-Dxxx-xxx	<input type="radio"/> 463A-OOA-DM-Dxxx-xxx	<input type="radio"/> 473A-OOA-DM-Dxxx-xxx

SOLENOID OPERATOR >

D **XX X- X XX**

XX Voltage	X Wire length	X Manual operator	XX Electrical connection
<input type="radio"/> JB 240/60, 220/50	<input type="radio"/> A 18" (Flying leads)	<input type="radio"/> 1 Non-locking	<input type="radio"/> KA Square connector
<input type="radio"/> JA 120/60, 110/50	<input type="radio"/> J Connector	<input type="radio"/> 2 Locking	<input type="radio"/> KD Square connector with light
<input type="radio"/> JC 24/60, 24/50	<input type="radio"/> x Other Options	<input type="radio"/> x Other Options	<input type="radio"/> JB Rectangular connector
<input type="radio"/> FB 24VDC (1.8 W)			<input type="radio"/> JD Rectangular connector with light
<input type="radio"/> DA 24VDC (5.4 W)			<input type="radio"/> BA Flying leads
<input type="radio"/> DF 24VDC (12.7 W)			<input type="radio"/> xx Other Options
<input type="radio"/> xx Other Options			

CBM404A-xxxxx-xx

HOW TO ORDER CIRCUIT BAR (BOTTOM CYLINDER PORTS) **

Port size	Pilot air	Spacing standard 19,5 mm		Spacing 26 mm (Rectangular connector)	
		w/o flow controls	w/ flow controls	w/o flow controls	w/ flow controls
1/8" NPTF	Internal	<input type="radio"/> CBM404A-00AAA-xx	<input type="radio"/> CBM404A-00BAA-xx	<input type="radio"/> CBM404A-02AAA-xx	<input type="radio"/> CBM404A-02BAA-xx
1/4" NPTF	Internal	<input type="radio"/> CBM404A-00AAD-xx	<input type="radio"/> CBM404A-00BAD-xx	<input type="radio"/> CBM404A-02AAD-xx	<input type="radio"/> CBM404A-02BAD-xx

Number of stations (03=3 stations)

** Other options available. Consult factory.

OPTIONS

413A-OOA-DM-Dxxx-xxx - clic with memory spring (replace by 6).

**TECHNICAL
DATA**

Fluid :	Compressed air, vacuum, inert gases		
Pressure range :	20 - 150 PSI		
Pilot pressure :	20 - 150 PSI		
Lubrication :	Not required, if used select a medium aniline point lubricant (between 180°F to 210°F)		
Filtration :	40 µ		
Temperature range :	0°F to 120°F (-18°C to +50°C)		
Orifice :	6.2 mm		
Flow :	1.0C _v		
:			
Coil :	General purpose class A, continuous duty, encapsulated		
Voltage range :	-15% to +10% of nominal voltage		
Protection :	NEMA 4		
Power :	~ Inrush : 10.9 VA	Holding : 7.7 VA	
	= 1.8 to 12.7 W		
Response times :	24 V= /5.4 W	Energize : 7.3 ms	De-energize : 5.3ms
	60Hz/6 W	Energize : 8-12 ms	De-energize : 7-11 ms

Spare parts : • Pilot valve : DMB-DXXX-XXX-1, including mounting screws 35069 and seal 16524.

Accessories : • Blanking plate : M-04002. • Flow control (x2) : N-04001. • Seal : 16525.
• Mounting screw (x2) : 35043.

Options : • BSPP threads. • Isolation of inlet and/or exhaust.

DIMENSIONS

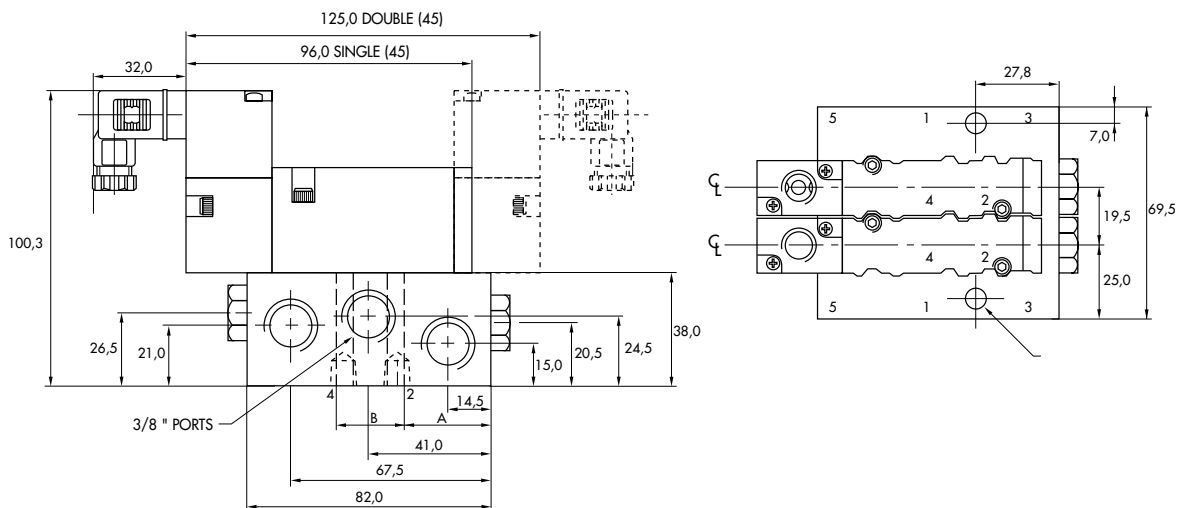

Port size	A	B
1/8"	31.5	19.0
1/4"	32.0	20.0

Function	Port size (NPTF)	Flow [Max]	Circuit bar mounting
5/2 - 5/3	1/8" - 1/4"	1.0C_v	mid profile - add on style cylinder ports in base

OPERATIONAL BENEFITS

1. The 4-way pilot develops maximum shifting forces both ways.
2. Memory spring available.
3. Balanced spool, immune to variations of pressure, also provides high flow.
4. Short stroke with high flow.
5. Bonded spool with minimum friction, shifting in a glass-like finished bore.
6. Pilot with balanced poppet, high flow, short and consistent response times.
7. Wiping effect eliminates sticking.
8. Long service life.

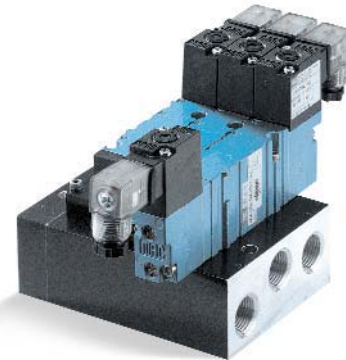

HOW TO ORDER

xxxx-xxx-DM-Dxxx-xxx

HOW TO ORDER VALVE FOR CIRCUIT BAR MOUNTING

Pilot air	5/2 Single operator	5/2 Double operator	5/3 Closed center	5/3 Open center	5/3 Pressure center
Internal	<input type="radio"/> 413A-OOA-DM-Dxxx-xxx	<input type="radio"/> 423A-OOA-DM-Dxxx-xxx	<input type="radio"/> 453A-OOA-DM-Dxxx-xxx	<input type="radio"/> 463A-OOA-DM-Dxxx-xxx	<input type="radio"/> 473A-OOA-DM-Dxxx-xxx

SOLENOID OPERATOR >

D XX X- X XX'

XX Voltage	X Wire length	X Manual operator	XX Electrical connection
<input type="radio"/> JB 240/60, 220/50	<input type="radio"/> A 18" (Flying leads)	<input type="radio"/> 1 Non-locking	<input type="radio"/> KA Square connector
<input type="radio"/> JA 120/60, 110/50	<input type="radio"/> J Connector	<input type="radio"/> 2 Locking	<input type="radio"/> KD Square connector with light
<input type="radio"/> JC 24/60, 24/50	<input type="radio"/> x Other Options	<input type="radio"/> x Other Options	<input type="radio"/> JB Rectangular connector
<input type="radio"/> FB 24VDC (1.8 W)			<input type="radio"/> JD Rectangular connector with light
<input type="radio"/> DA 24VDC (5.4 W)			<input type="radio"/> BA Flying leads
<input type="radio"/> DF 24VDC (12.7 W)			<input type="radio"/> xx Other Options
<input type="radio"/> xx Other Options			

CBM404A-xxxxx-xx

HOW TO ORDER CIRCUIT BAR (BOTTOM CYLINDER PORTS) **

Port size	Pilot air	Spacing standard 19,5 mm		Spacing 26 mm (Rectangular connector)	
		w/o flow controls	w/ flow controls	w/o flow controls	w/ flow controls
1/8" NPTF	Internal	<input type="radio"/> CBM404A-00ABA-xx	<input type="radio"/> CBM404A-00BBA-xx	<input type="radio"/> CBM404A-02ABA-xx	<input type="radio"/> CBM404A-02BBA-xx
1/4" NPTF	Internal	<input type="radio"/> CBM404A-00ABD-xx	<input type="radio"/> CBM404A-00BBD-xx	<input type="radio"/> CBM404A-02ABD-xx	<input type="radio"/> CBM404A-02BBD-xx

Number of stations (03=3 stations)

** Other options available. Consult factory.

Note: add-a-unit stations may be added to above bars.

OPTIONS

413A-OOA-DM-Dxxx-xxx - clic with memory spring, replace by 6.

**TECHNICAL
DATA**

Fluid :	Compressed air, vacuum, inert gases		
Pressure range :	20 - 150 PSI		
Pilot pressure :	20 - 150 PSI		
Lubrication :	Not required, if used select a medium aniline point lubricant (between 180°F to 210°F)		
Filtration :	40 µ		
Temperature range :	0°F to 120°F (-18°C to +50°C)		
Orifice :	6.2 mm		
Flow :	1.0C _v		
Coil :	General purpose class A, continuous duty, encapsulated		
Voltage range :	-15% to +10% of nominal voltage		
Protection :	NEMA 4		
Power :	~ Inrush : 10.9 VA	Holding : 7.7 VA	
	= 1.8 to 12.7 W		
Response times :	24 V= / 5.4 W	Energize : 7.3 ms	De-energize : 5.3ms
	60Hz / 6 W	Energize : 8-12 ms	De-energize : 7-11 ms

Spare parts : • Pilot valve : DMB-DXXX-XXX-1, including mounting screws 35069 and seal 16524.

Accessories : • Blanking plate : M-04002. • Flow control (x2) : N-04001. • Seal : 16525.
• Mounting screw (x2) : 35043. • End plate kit : M-04003-01.

Options : • BSPP threads. • Isolation of inlet and/or exhaust.

DIMENSIONS

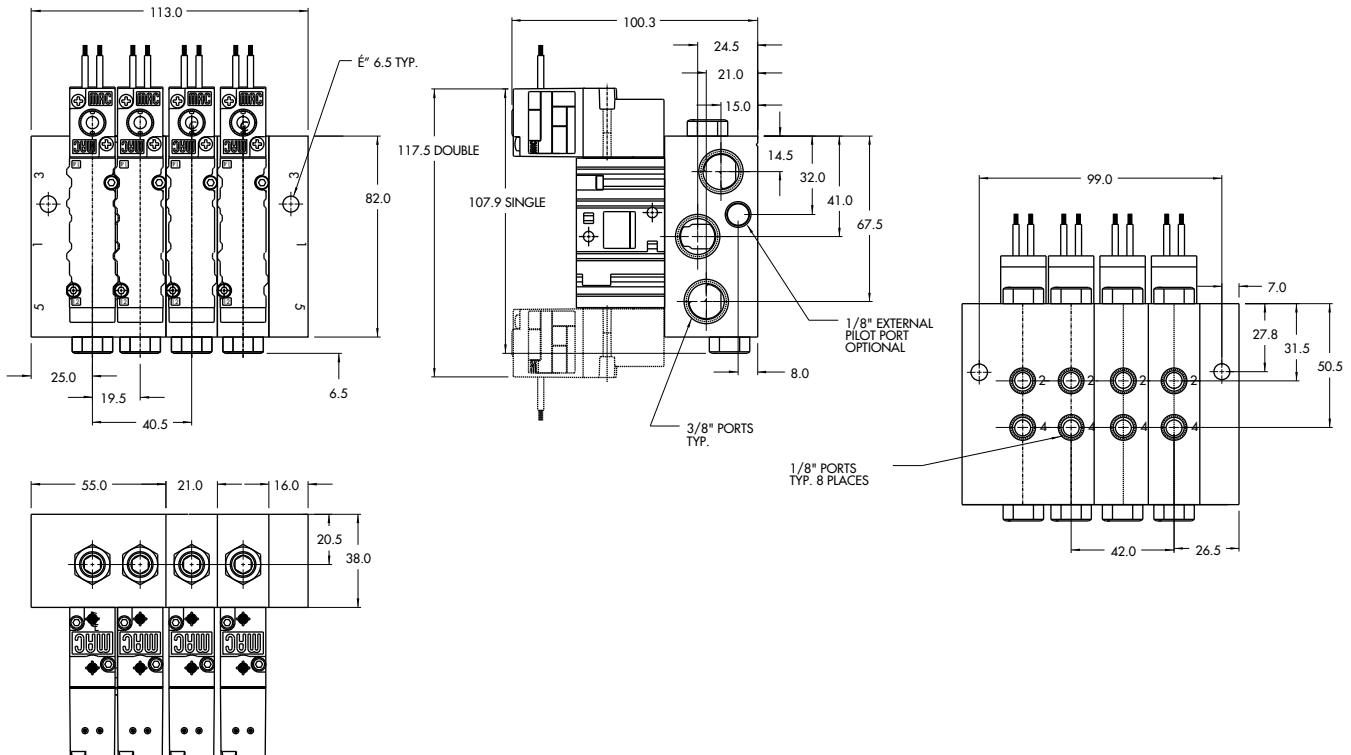

Function	Port size (NPTF)	Flow (Max)	Circuit bar mounting
5/2 - 5/3	1/8" - 1/4"	1.0C_v	add-a-unit stations for CBM404A bar

OPERATIONAL BENEFITS

1. The 4-way pilot develops maximum shifting forces both ways.
2. Memory spring available.
3. Balanced spool, immune to variations of pressure, also provides high flow.
4. Short stroke with high flow.
5. Bonded spool with minimum friction, shifting in a glass-like finished bore.
6. Pilot with balanced poppet, high flow, short and consistent response times.
7. Wiping effect eliminates sticking.
8. Long service life.



HOW TO ORDER

xxxx-xxx-DM-Dxxx-xxx

HOW TO ORDER VALVE FOR CIRCUIT BAR MOUNTING

Pilot air	5/2 Single operator	5/2 Double operator	5/3 Closed center	5/3 Open center	5/3 Pressure center
Internal	<input type="radio"/> 413A-OOA-DM-Dxxx-xxx	<input type="radio"/> 423A-OOA-DM-Dxxx-xxx	<input type="radio"/> 453A-OOA-DM-Dxxx-xxx	<input type="radio"/> 463A-OOA-DM-Dxxx-xxx	<input type="radio"/> 473A-OOA-DM-Dxxx-xxx

SOLENOID OPERATOR >

D XX X- X XX'

XX Voltage	X Wire length	X Manual operator	XX Electrical connection
<input type="radio"/> JB 240/60, 220/50	<input type="radio"/> A 18" (Flying leads)	<input type="radio"/> 1 Non-locking	<input type="radio"/> KA Square connector
<input type="radio"/> JA 120/60, 110/50	<input type="radio"/> J Connector	<input type="radio"/> 2 Locking	<input type="radio"/> KD Square connector with light
<input type="radio"/> JC 24/60, 24/50	<input type="radio"/> x Other Options	<input type="radio"/> x Other Options	<input type="radio"/> JB Rectangular connector
<input type="radio"/> FB 24VDC (1.8 W)			<input type="radio"/> JD Rectangular connector with light
<input type="radio"/> DA 24VDC (5.4 W)			<input type="radio"/> BA Flying leads
<input type="radio"/> DF 24VDC (12.7 W)			<input type="radio"/> xx Other Options
<input type="radio"/> xx Other Options			

CBM404A-xxxxx-xx

HOW TO ORDER CIRCUIT BAR (BOTTOM CYLINDER PORTS) **

Port size	Pilot air	Spacing 21 mm		Spacing 26 mm (Rectangular connector)	
		w/o flow controls	w/ flow controls	w/o flow controls	w/ flow controls
1/8" NPTF	Internal	<input type="radio"/> CBM404A-01AEA-xx	<input type="radio"/> CBM404A-01BEA-xx	<input type="radio"/> CBM404A-02AEA-xx	<input type="radio"/> CBM404A-02BEA-xx
1/4" NPTF	Internal	<input type="radio"/> CBM404A-01AED-xx	<input type="radio"/> CBM404A-01BED-xx	<input type="radio"/> CBM404A-02AED-xx	<input type="radio"/> CBM404A-02BED-xx

Number of stations (01, 02, 03, or 04)

** Other options available. Consult factory.

OPTIONS

413A-OOA-DM-Dxxx-xxx - clic with memory spring (replace by 6).

**TECHNICAL
DATA**

Fluid :	Compressed air, vacuum, inert gases		
Pressure range :	20 - 150 PSI		
Pilot pressure :	20 - 150 PSI		
Lubrication :	Not required, if used select a medium aniline point lubricant (between 180°F to 210°F)		
Filtration :	40 µ		
Temperature range :	0°F to 120°F (-18°C to +50°C)		
Orifice :	6.2 mm		
Flow :	1.0C _v		
Coil :	General purpose class A, continuous duty, encapsulated		
Voltage range :	-15% to +10% of nominal voltage		
Protection :	NEMA 4		
Power :	~ Inrush : 10.9 VA	Holding : 7.7 VA	
	= 1.8 to 12.7 W		
Response times :	24 V= /5.4 W	Energize : 7.3 ms	De-energize : 5.3ms
	60Hz/6 W	Energize : 8-12 ms	De-energize : 7-11 ms

Spare parts : • Pilot valve : DMB-DXXX-XXX-1, including mounting screws 35069 and seal 16524.

Accessories : • Blanking plate : M-04002. • Flow control (x2) : N-04001. • Seal : 16525.
• Mounting screw (x2) : 35043. • End plate kit : M-04003-01.

Options : • BSPP threads. • Isolation of inlet and/or exhaust.

DIMENSIONS

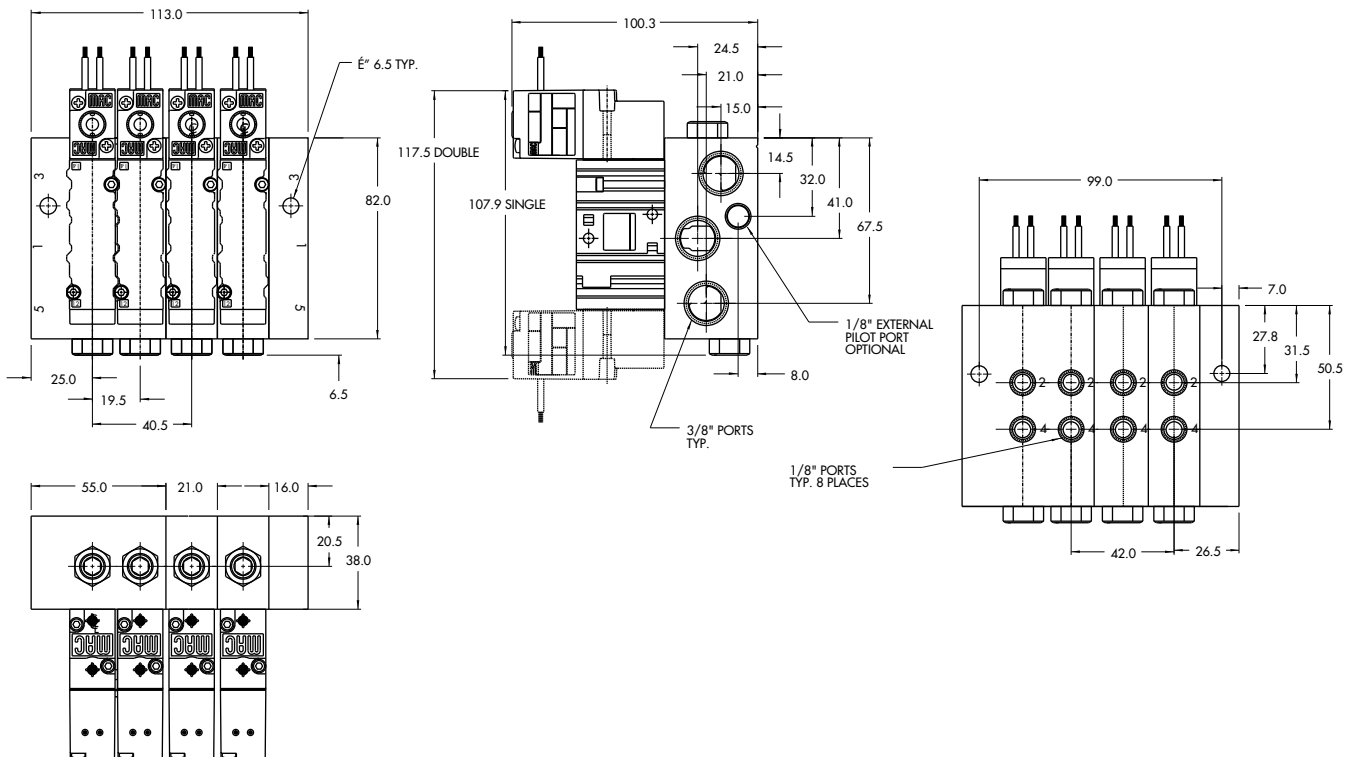

Function	Port size (NPTF)	Flow [Max]	Circuit bar mounting
5/2 - 5/3	1/8" - 1/4"	1.0C_v	high profile cylinder ports in base

OPERATIONAL BENEFITS

1. The 4-way pilot develops maximum shifting forces both ways.
2. Memory spring available.
3. Balanced spool, immune to variations of pressure, also provides high flow.
4. Short stroke with high flow.
5. Bonded spool with minimum friction, shifting in a glass-like finished bore.
6. Pilot with balanced poppet, high flow, short and consistent response times.
7. Wiping effect eliminates sticking.
8. Long service life.



HOW TO ORDER

xxxx-xxx-DM-Dxxx-xxx

HOW TO ORDER VALVE FOR CIRCUIT BAR MOUNTING

Pilot air	5/2 Single operator	5/2 Double operator	5/3 Closed center	5/3 Open center	5/3 Pressure center
Internal	<input type="radio"/> 413A-OOA-DM-Dxxx-xxx	<input type="radio"/> 423A-OOA-DM-Dxxx-xxx	<input type="radio"/> 453A-OOA-DM-Dxxx-xxx	<input type="radio"/> 463A-OOA-DM-Dxxx-xxx	<input type="radio"/> 473A-OOA-DM-Dxxx-xxx
External	<input type="radio"/> 413A-OOD-DM-Dxxx-xxx	<input type="radio"/> 423A-OOD-DM-Dxxx-xxx	<input type="radio"/> 453A-OOD-DM-Dxxx-xxx	<input type="radio"/> 463A-OOD-DM-Dxxx-xxx	<input type="radio"/> 473A-OOD-DM-Dxxx-xxx

SOLENOID OPERATOR >

D XX X- X XX*

XX Voltage	X Wire length	X Manual operator	XX Electrical connection
<input type="radio"/> JB 240/60, 220/50	<input type="radio"/> A 18" (Flying leads)	<input type="radio"/> 1 Non-locking	<input type="radio"/> KA Square connector
<input type="radio"/> JA 120/60, 110/50	<input type="radio"/> J Connector	<input type="radio"/> 2 Locking	<input type="radio"/> KD Square connector with light
<input type="radio"/> JC 24/60, 24/50	<input type="radio"/> x Other Options	<input type="radio"/> x Other Options	<input type="radio"/> JB Rectangular connector
<input type="radio"/> FB 24VDC (1.8 W)			<input type="radio"/> JD Rectangular connector with light
<input type="radio"/> DA 24VDC (5.4 W)			<input type="radio"/> BA Flying leads
<input type="radio"/> DF 24VDC (12.7 W)			<input type="radio"/> xx Other Options
<input type="radio"/> xx Other Options			

CBM405A-xxxxx-xx

HOW TO ORDER CIRCUIT BAR (SIDE CYLINDER PORTS) **

Port size	Pilot air	Spacing standard 19,5 mm	Spacing 26 mm (Rectangular connector)
1/8" NPTF	Internal	<input type="radio"/> CBM405A-00AAA-xx	<input type="radio"/> CBM405A-02AAA-xx
	Common external	<input type="radio"/> CBM405A-00BAA-xx	<input type="radio"/> CBM405A-02BAA-xx
1/4" NPTF	Internal	<input type="radio"/> CBM405A-00AAD-xx	<input type="radio"/> CBM405A-02AAD-xx
	Common external	<input type="radio"/> CBM405A-00BAD-xx	<input type="radio"/> CBM405A-02BAD-xx

Number of stations (03=3 stations)
 ** Other options available. Consult factory.

OPTIONS

413A-OOA-DM-Dxxx-xxx - clic with memory spring (replace by 6).

**TECHNICAL
DATA**

Fluid :	Compressed air, vacuum, inert gases
Pressure range :	Internal pilot : 20 - 150 PSI External pilot : vacuum - 150 PSI
Pilot pressure :	20 - 150 PSI
Lubrication :	Not required, if used select a medium aniline point lubricant (between 180°F to 210°F)
Filtration :	40 μ
Temperature range :	0°F to 120°F (-18°C to +50°C)
Orifice :	6.2 mm
Flow :	1.0C _v
Coil :	General purpose class A, continuous duty, encapsulated
Voltage range :	-15% to +10% of nominal voltage
Protection :	NEMA 4
Power :	~ Inrush : 10.9 VA Holding : 7.7 VA = 1.8 to 12.7 W
Response times :	24 V= / 5.4 W Energize : 7.3 ms De-energize : 5.3ms 60Hz/ 6 W Energize : 8-12 ms De-energize : 7-11 ms

- Spare parts : • Pilot valve : DMB-DXXX-XXX-1, including mounting screws 35069 and seal 16524.
- Accessories : • Blanking plate : M-04002. • Seal : 16525. • Mounting screw (x2) : 35043.
- Options : • BSPP threads. • Isolation of inlet and/or exhaust.

DIMENSIONS

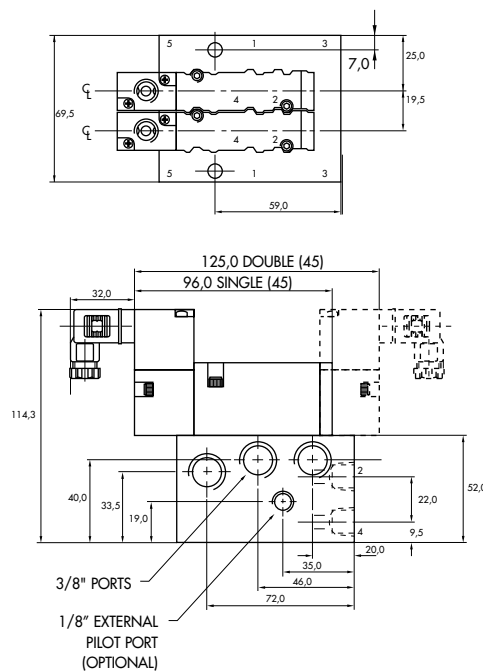

Function	Port size (NPTF)	Flow [Max]	Circuit bar mounting
5/2 - 5/3	1/8" - 1/4"	1.0C_v	high profile - add on style cylinder ports in base

OPERATIONAL BENEFITS

1. The 4-way pilot develops maximum shifting forces both ways.
2. Memory spring available.
3. Balanced spool, immune to variations of pressure, also provides high flow.
4. Short stroke with high flow.
5. Bonded spool with minimum friction, shifting in a glass-like finished bore.
6. Pilot with balanced poppet, high flow, short and consistent response times.
7. Wiping effect eliminates sticking.
8. Long service life.

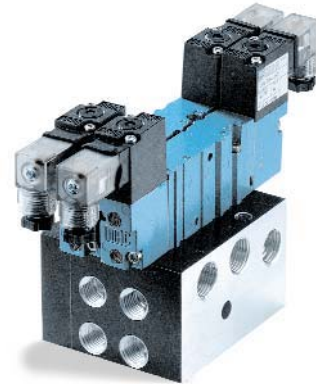

HOW TO ORDER

xxxx-xxx-DM-Dxxx-xxx

HOW TO ORDER VALVE FOR CIRCUIT BAR MOUNTING

Pilot air	5/2 Single operator	5/2 Double operator	5/3 Closed center	5/3 Open center	5/3 Pressure center
Internal	<input type="radio"/> 413A-OOA-DM-Dxxx-xxx	<input type="radio"/> 423A-OOA-DM-Dxxx-xxx	<input type="radio"/> 453A-OOA-DM-Dxxx-xxx	<input type="radio"/> 463A-OOA-DM-Dxxx-xxx	<input type="radio"/> 473A-OOA-DM-Dxxx-xxx
External	<input type="radio"/> 413A-OOD-DM-Dxxx-xxx	<input type="radio"/> 423A-OOD-DM-Dxxx-xxx	<input type="radio"/> 453A-OOD-DM-Dxxx-xxx	<input type="radio"/> 463A-OOD-DM-Dxxx-xxx	<input type="radio"/> 473A-OOD-DM-Dxxx-xxx

SOLENOID OPERATOR >

D XX X- X XX*

XX Voltage	X Wire length	X Manual operator	XX Electrical connection
<input type="radio"/> JB 240/60, 220/50	<input type="radio"/> A 18" (Flying leads)	<input type="radio"/> 1 Non-locking	<input type="radio"/> KA Square connector
<input type="radio"/> JA 120/60, 110/50	<input type="radio"/> J Connector	<input type="radio"/> 2 Locking	<input type="radio"/> KD Square connector with light
<input type="radio"/> JC 24/60, 24/50	<input type="radio"/> x Other Options	<input type="radio"/> x Other Options	<input type="radio"/> JB Rectangular connector
<input type="radio"/> FB 24VDC (1.8 W)			<input type="radio"/> JD Rectangular connector with light
<input type="radio"/> DA 24VDC (5.4 W)			<input type="radio"/> BA Flying leads
<input type="radio"/> DF 24VDC (12.7 W)			<input type="radio"/> xx Other Options
<input type="radio"/> xx Other Options			

CBM405A-xxxxx-xx

HOW TO ORDER CIRCUIT BAR (SIDE CYLINDER PORTS) **

Port size	Pilot air	Spacing standard 19,5 mm	Spacing 26 mm (Rectangular connector)
1/8" NPTF	Internal	<input type="radio"/> CBM405A-00ABA-xx	<input type="radio"/> CBM405A-02ABA-xx
	Common external	<input type="radio"/> CBM405A-00BCA-xx	<input type="radio"/> CBM405A-02BCA-xx
1/4" NPTF	Internal	<input type="radio"/> CBM405A-00ABD-xx	<input type="radio"/> CBM405A-02ABD-xx
	Common external	<input type="radio"/> CBM405A-00BCD-xx	<input type="radio"/> CBM405A-02BCD-xx

Number of stations (03=3 stations)

** Other options available. Consult factory.

Note: add-a-unit stations may be added to above bars.

OPTIONS

413A-OOA-DM-Dxxx-xxx
 clic with memory spring (replace by 6).

**TECHNICAL
DATA**

Fluid :	Compressed air, vacuum, inert gases		
Pressure range :	Internal pilot : 20 - 150 PSI External pilot : vacuum - 150 PSI		
Pilot pressure :	20 - 150 PSI		
Lubrication :	Not required, if used select a medium aniline point lubricant (between 180°F to 210°F)		
Filtration :	40 µ		
Temperature range :	0°F to 120°F (-18°C to +50°C)		
Orifice :	6.2 mm		
Flow :	1.0C _v		
Coil :	General purpose class A, continuous duty, encapsulated		
Voltage range :	-15% to +10% of nominal voltage		
Protection :	NEMA 4		
Power :	~ Inrush : 10.9 VA	Holding : 7.7 VA	
	= 1.8 to 12.7 W		
Response times :	24 V=/5.4 W	Energize : 7.3 ms	De-energize : 5.3ms
	60Hz/6 W	Energize : 8-12 ms	De-energize : 7-11 ms

- Spare parts : • Pilot valve : DMB-DXXX-XXX-1, including mounting screws 35069 and seal 16524.
- Accessories : • Blanking plate : M-04002. • Seal : 16525. • Mounting screw (x2) : 35043.
• End plate kit : M-04005-01. • End plate kit for common external pilot : M-04006-01.
- Options : • BSPP threads. • Isolation of inlet and/or exhaust.

DIMENSIONS

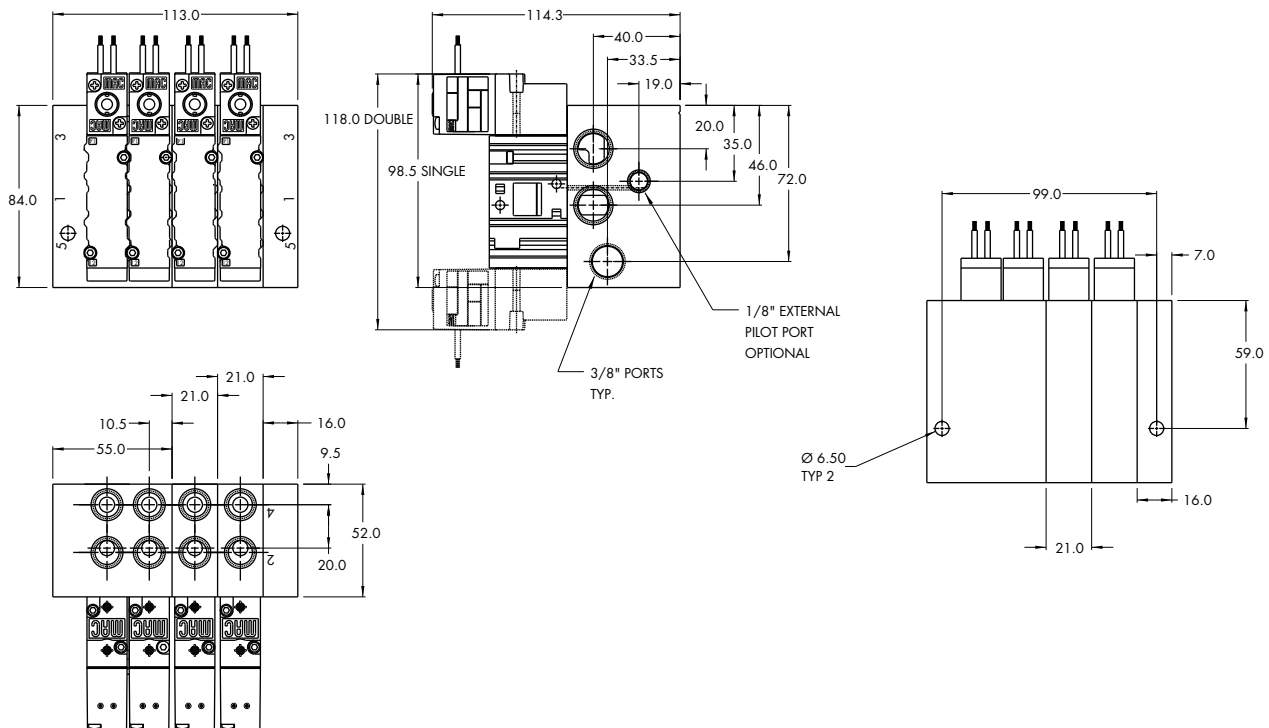

Function	Port size (NPTF)	Flow [Max]	Circuit bar mounting
5/2 - 5/3	1/8" - 1/4"	1.0C_v	add-a-unit stations for CBM405A bar

OPERATIONAL BENEFITS

1. The 4-way pilot develops maximum shifting forces both ways.
2. Memory spring available.
3. Balanced spool, immune to variations of pressure, also provides high flow.
4. Short stroke with high flow.
5. Bonded spool with minimum friction, shifting in a glass-like finished bore.
6. Pilot with balanced poppet, high flow, short and consistent response times.
7. Wiping effect eliminates sticking.
8. Long service life.



HOW TO ORDER

xxxx-xxx-DM-Dxxx-xxx

HOW TO ORDER VALVE FOR CIRCUIT BAR MOUNTING

Pilot air	5/2 Single operator	5/2 Double operator	5/3 Closed center	5/3 Open center	5/3 Pressure center
Internal	413A-OOA-DM-Dxxx-xxx	423A-OOA-DM-Dxxx-xxx	453A-OOA-DM-Dxxx-xxx	463A-OOA-DM-Dxxx-xxx	473A-OOA-DM-Dxxx-xxx
External	413A-OOD-DM-Dxxx-xxx	423A-OOD-DM-Dxxx-xxx	453A-OOD-DM-Dxxx-xxx	463A-OOD-DM-Dxxx-xxx	473A-OOD-DM-Dxxx-xxx

SOLENOID OPERATOR >

D XX X- X XX*

XX Voltage	X Wire length	X Manual operator	XX Electrical connection
<input type="radio"/> JB 240/60, 220/50	<input type="radio"/> A 18" (Flying leads)	<input type="radio"/> 1 Non-locking	<input type="radio"/> KA Square connector
<input type="radio"/> JA 120/60, 110/50	<input type="radio"/> J Connector	<input type="radio"/> 2 Locking	<input type="radio"/> KD Square connector with light
<input type="radio"/> JC 24/60, 24/50	<input type="radio"/> x Other Options	<input type="radio"/> x Other Options	<input type="radio"/> JB Rectangular connector
<input type="radio"/> FB 24VDC (1.8 W)			<input type="radio"/> JD Rectangular connector with light
<input type="radio"/> DA 24VDC (5.4 W)			<input type="radio"/> BA Flying leads
<input type="radio"/> DF 24VDC (12.7 W)			<input type="radio"/> xx Other Options
<input type="radio"/> xx Other Options			

CBM405A-xxxxx-xx

HOW TO ORDER CIRCUIT BAR (SIDE CYLINDER PORTS) **

Port size	Pilot air	Spacing 21 mm	Spacing 26 mm (Rectangular connector)
1/8" NPTF	Internal	<input type="radio"/> CBM405A-01AEA-xx	<input type="radio"/> CBM405A-02AEA-xx
	Common external	<input type="radio"/> CBM405A-01BEA-xx	<input type="radio"/> CBM405A-02BEA-xx
1/4" NPTF	Internal	<input type="radio"/> CBM405A-01AED-xx	<input type="radio"/> CBM405A-02AED-xx
	Common external	<input type="radio"/> CBM405A-01BED-xx	<input type="radio"/> CBM405A-02BED-xx

Number of stations (01, 02, 03, or 04)

** Other options available. Consult factory.

OPTIONS

413A-OOA-DM-Dxxx-xxx
 clic with memory spring (replace by 6).

TECHNICAL DATA

Fluid :	Compressed air, vacuum, inert gases		
Pressure range :	Internal pilot : 20 - 150 PSI External pilot : vacuum - 150 PSI		
Pilot pressure :	20 - 150 PSI		
Lubrication :	Not required, if used select a medium aniline point lubricant (between 180°F to 210°F)		
Filtration :	40 µ		
Temperature range :	0°F to 120°F (-18°C to +50°C)		
Orifice :	6.2 mm		
Flow :	1.0C _v		
Coil :	General purpose class A, continuous duty, encapsulated		
Voltage range :	-15% to +10% of nominal voltage		
Protection :	NEMA 4		
Power :	~ Inrush : 10.9 VA Holding : 7.7 VA = 1.8 to 12.7 W		
Response times :	24 V=/5.4 W	Energize : 7.3 ms	De-energize : 5.3ms
	60Hz/6 W	Energize : 8-12 ms	De-energize : 7-11 ms

- Spare parts : • Pilot valve : DMB-DXXX-XXX-1, including mounting screws 35069 and seal 16524.
- Accessories : • Blanking plate : M-04002. • Seal : 16525. • Mounting screw (x2) : 35043.
• End plate kit : M-04005-01. • End plate kit for common external pilot : M-04006-01.
- Options : • BSPP threads. • Isolation of inlet and/or exhaust.

DIMENSIONS

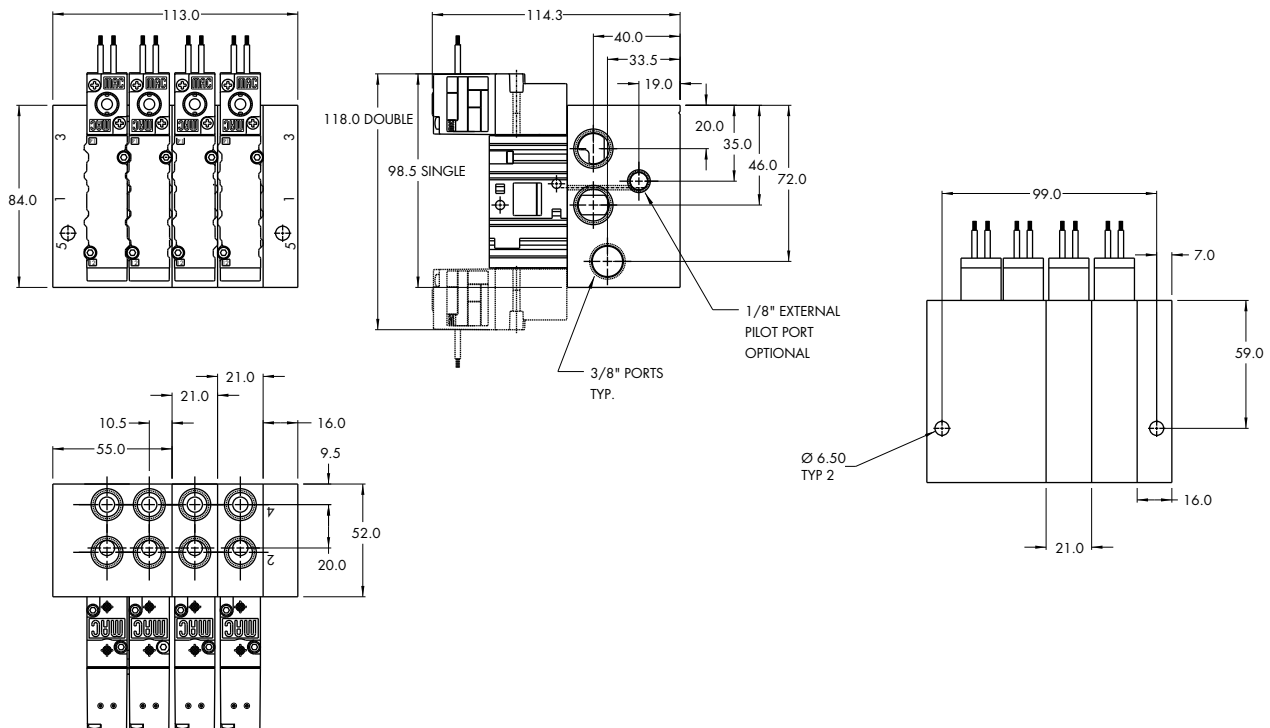



Section 2

Options



0 p t i o n s

Codification table for voltages / Wire length / Manual operator / Electrical connection

VALVE CODE ➤

DM-DXX X - X XX
1 2 3 4

OPTIONS AVAILABLE FOR

- pilot operated valves 400, 52 & 92 Series

1. VOLTAGE

- D XX X - X XX VOLTAGE

<input type="radio"/> DB	12 VDC (5.4 W)
<input type="radio"/> DC	12 VDC (7.5 W)
<input type="radio"/> DD	24 VDC (7.3 W)
<input type="radio"/> DE	12 VDC (12.7 W)
<input type="radio"/> DK	110 VDC (5.8 W)
<input type="radio"/> DJ	28 VDC (5.7 W)
<input type="radio"/> DL	64 VDC (6.0 W)
<input type="radio"/> DM	36 VDC (5.8 W)
<input type="radio"/> DN	6 VDC (6.0 W)
<input type="radio"/> DR	90 VDC (6,6 W)
<input type="radio"/> DS	110 VDC (7.3 W), 100 VDC (6.0 W)
<input type="radio"/> DT	75 VDC (5.6 W)
<input type="radio"/> DP	48 VDC (5.8 W)
<input type="radio"/> FA	12 VDC (1.8 W)
<input type="radio"/> FE	12 VDC (2.4 W)
<input type="radio"/> FF	24 VDC (2.4 W)
<input type="radio"/> JD	100/60, 100/50, 110/60

2. WIRE LENGTH

- D XX X - X XX WIRE LENGTH

<input type="radio"/> B	24"
<input type="radio"/> C	36"
<input type="radio"/> D	48"
<input type="radio"/> E	72"
<input type="radio"/> F	96"



3. MANUAL OPERATOR

- D XX X - X XX	MANUAL OPERATOR
<input type="radio"/> 0	No operator
<input type="radio"/> 1	Non-locking recessed
<input type="radio"/> 2	Locking recessed
<input type="radio"/> 3	Non-locking extended
<input type="radio"/> 4	Locking extended

4. ELECTRICAL CONNECTION

- D XX X - X XX	ELECTRICAL CONNECTION
<input type="radio"/> BA	Flying leads
<input type="radio"/> BK	BA with protection diode
<input type="radio"/> BL	BA with protection varistor
<input type="radio"/> CA	1/2" NPS conduit
<input type="radio"/> JB	Rectangular connector
<input type="radio"/> JD	Rectangular connector with light
<input type="radio"/> JM	Rectangular connector, male only
<input type="radio"/> KA	Square connector
<input type="radio"/> KB	Square connector with protection diode
<input type="radio"/> KC	Square connector with protection varistor
<input type="radio"/> KD	Square connector with light
<input type="radio"/> KE	Square connector with light and protection diode
<input type="radio"/> KF	Square connector with light and protection varistor
<input type="radio"/> KJ	Square connector (male only)
<input type="radio"/> KK	Square connector with protection diode (male only)
<input type="radio"/> KL	Square connector with protection varistor (male only)
<input type="radio"/> TA	Dual tabs
<input type="radio"/> TB	TA with protection diode
<input type="radio"/> TD	TA with light
<input type="radio"/> TE	TA with light and protection diode
<input type="radio"/> TJ	Dual tabs (male only)
<input type="radio"/> TK	TJ with protection diode
<input type="radio"/> TM	TJ with light
<input type="radio"/> TN	TJ with light and protection diode
<input type="radio"/> *DN	Plug-in with diode
<input type="radio"/> *DP	Plug-in with M.O.V.
<input type="radio"/> *DH	Plug-in with diode & ground
<input type="radio"/> *DJ	Plug-in with M.O.V & ground

* These options only apply to the 92 series. All others are for the 400 and 52 series.

MOD. S009

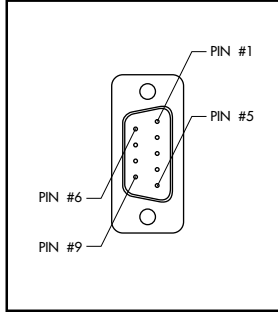

TECHNICAL DATA

- Type «SUB_D»
- Number of contacts : 9
- Solder termination (Dia. 0.6 mm/0.14 mm²/26-22 AWG)
- Operating current 5 A/contact
- Rated voltage 125 V~
- Temp. range -40° to +125°C
- Insulation resistance ≥ 5.0⁹ Ω
- Protection class IP40 (DIN 40050)
- Number of solenoids : 7 max.
- Max. 24 V=/5.4 W per solenoid
- 2 common wires

MOD. S015

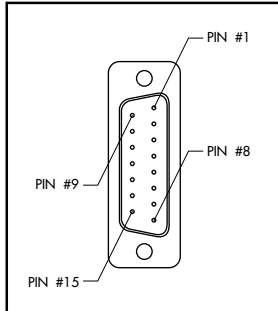

TECHNICAL DATA

- Type «SUB_D»
- Number of contacts : 15
- Solder termination (Dia. 0.6 mm/0.14 mm²/26-22 AWG)
- Operating current 5 A/contact
- Rated voltage 125 V~
- Temp. range -40° to +125°C
- Insulation resistance ≥ 5.0⁹ Ω
- Protection class IP40 (DIN 40050)
- Number of solenoids : 12 max.
- Max. 24 V=/5.4 W per solenoid
- 3 common wires

MOD. S025

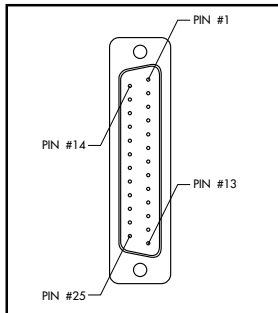

TECHNICAL DATA

- Type «SUB_D»
- Number of contacts : 25
- Solder termination (Dia. 0.6 mm/0.14 mm²/26-22 AWG)
- Operating current 5 A/contact
- Rated voltage 125 V~
- Temp. range -40° to +125°C
- Insulation resistance ≥ 5.0⁹ Ω
- Protection class IP40 (DIN 40050)
- Number of solenoids : 20 max.
- Max. 24 V=/5.4 W per solenoid
- 5 common wires

Note : Use desired MOD. number after circuit bar part number

Connector termination details

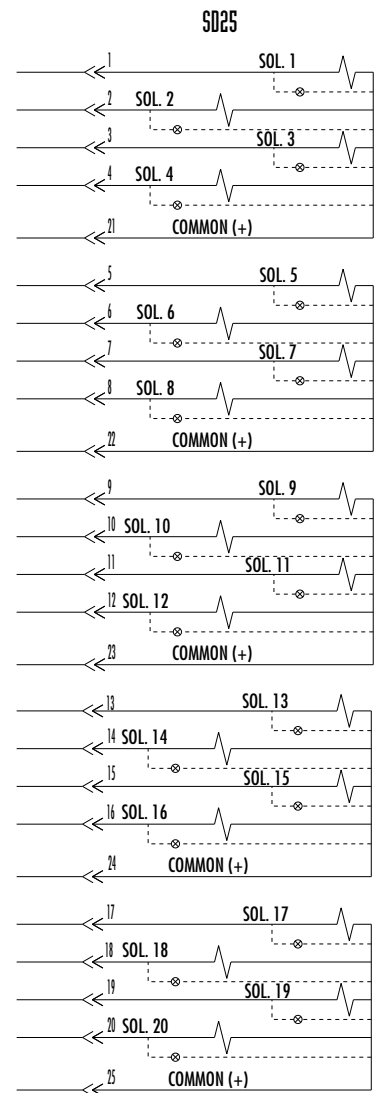
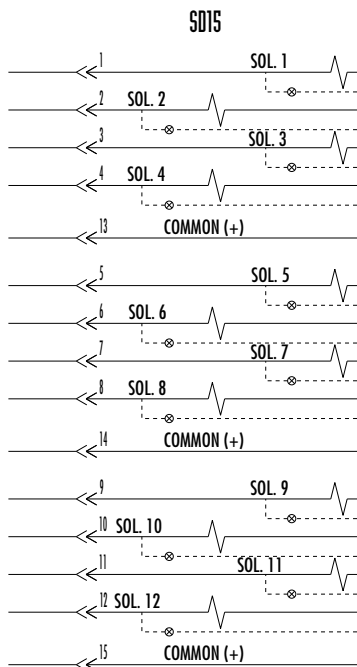
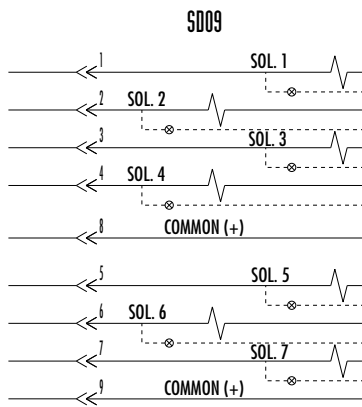
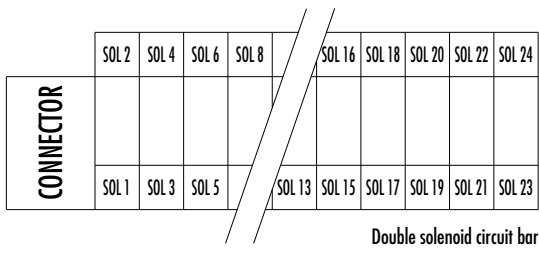
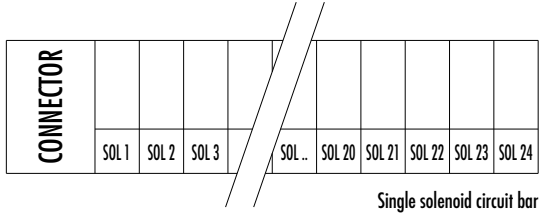

Circuit bar mounting

standard	add-on style	add-a-unit stations for CBM092B
----------	--------------	---------------------------------

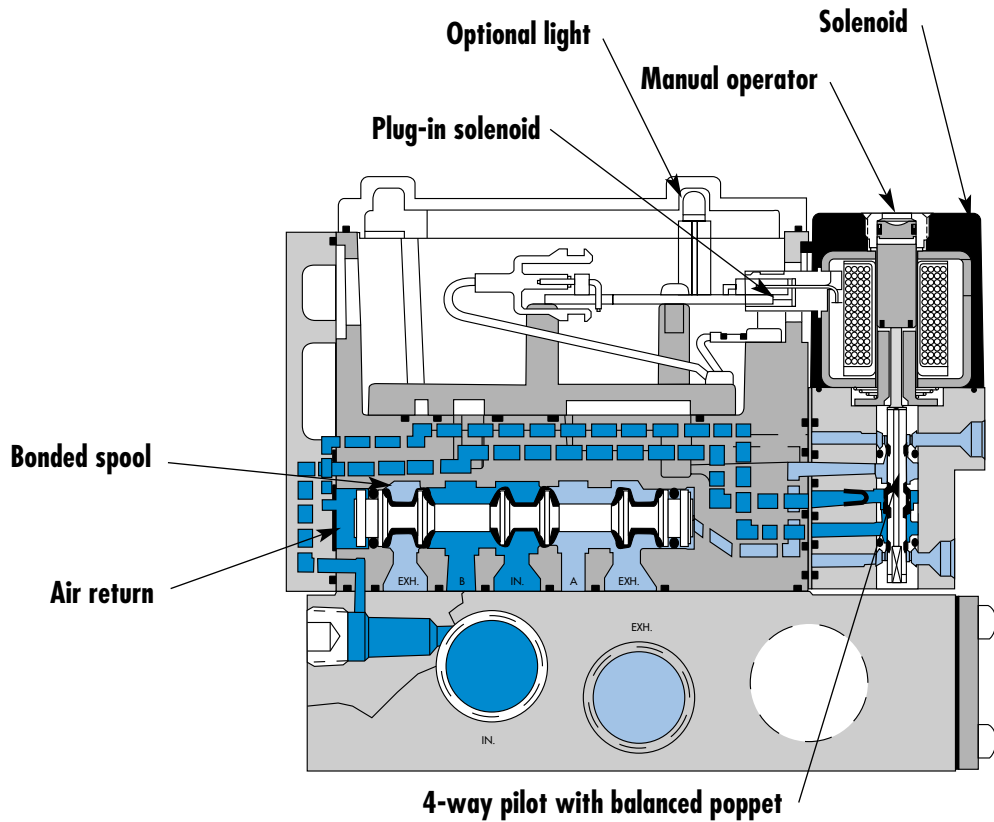

SERIES FEATURES

- Patented MACSOLENOID[®] for fastest possible response times and virtually burn-out proof AC solenoid operation.
- Optional low watt DC solenoids.
- Optional memory spring.
- Plug-in design of valves and bases for ease of maintenance.
- 2 position or 3 position valve configurations.

Function	Port size	Flow [Max]	Circuit bar mounting
5/2 - 5/3 - 3/2	1/8 - 1/4 - 3/8	1.0C_v	standard

OPERATIONAL BENEFITS

1. The 4-way pilot develops maximum shifting forces both ways.
2. Memory spring available.
3. Balanced spool, immune to variations of pressure, also provides high flow.
4. Short stroke with high flow.
5. Bonded seal spool with minimum friction, shifting in a glass-like finished bore.
6. Pilot with balanced poppet, high flow, short and consistent response times.
7. Wiping effect eliminates sticking.
8. Long service life.



92B-xxx-000-DM-DxxP-xxx

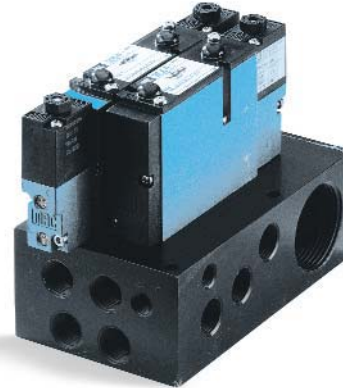

HOW TO ORDER VALVE FOR CIRCUIT BAR MOUNTING

SINGLE PRESSURE MODELS

Port size (see circuit bar)	5/2 Single operator	5/2 Double operator	5/3 Closed center	5/3 Open center	5/3 Pressure center
Valve less base	<input type="radio"/> 92B-AAA-000-DM-DxxP-xx	<input type="radio"/> 92B-BAA-000-DM-DxxP-xx	<input type="radio"/> 92B-EAA-000-DM-DxxP-xx	<input type="radio"/> 92B-FAA-000-DM-DxxP-xx	<input type="radio"/> 92B-GAA-000-DM-DxxP-xx

DUAL PRESSURE MODELS (REQUIRES SANDWICH PRESSURE REGULATOR)

Port size (see circuit bar)	5/2 Single operator	5/2 Double operator
Valve less base	<input type="radio"/> 92B-CAA-000-DM-DxxP-xxx	<input type="radio"/> 92B-DAA-000-DM-DxxP-xxx

SOLENOID OPERATOR >

DM-DxxP-xxx

XX Voltage	X Manual operator	XX Electrical connection
<input type="radio"/> JB 240/60, 220/50	<input type="radio"/> 1 Non-locking	<input type="radio"/> DM Plug-in
<input type="radio"/> JA 120/60, 110/50	<input type="radio"/> 2 Locking	<input type="radio"/> DG Plug-in w/ground
<input type="radio"/> JC 24/60, 24/50	<input type="radio"/> xx Other Options	
<input type="radio"/> FB 24VDC (1.8 W)		Note : Ground wire required for solenoids 30 volts and above.
<input type="radio"/> DA 24VDC (5.4 W)		<input type="radio"/> xx Other Options
<input type="radio"/> DF 24VDC (12.7 W)		
<input type="radio"/> xx Other Options		

HOW TO ORDER CIRCUIT BAR

CBM092B-01xxx-AOxx

Port size	Pilot air	Side cylinder ports (25 mm)	Bottom cylinder ports (25 mm)
1/8 NPTF	Internal	<input type="radio"/> CBM092B-01AAA-A0*xx	<input type="radio"/> CBM092B-01BAA-A0*xx
	Common external	<input type="radio"/> CBM092B-01CAA-A0*xx	<input type="radio"/> CBM092B-01DAA-A0*xx
1/4 NPTF	Internal	<input type="radio"/> CBM092B-01AAD-A0*xx	<input type="radio"/> CBM092B-01BAD-A0*xx
	Common external	<input type="radio"/> CBM092B-01CAD-A0*xx	<input type="radio"/> CBM092B-01DAD-A0*xx
3/8 NPTF	Internal	<input type="radio"/> CBM092B-01AAG-A0*xx	<input type="radio"/> CBM092B-01BAG-A0*xx
	Common external	<input type="radio"/> CBM092B-01CAG-A0*xx	<input type="radio"/> CBM092B-01DAG-A0*xx

Number of stations (03=3 stations)

Note : clic for valves mounted on base at the factory (add - 9 to the model number).
for multi-pin connector (9, 15 or 25).

* If replaced by BO : circuit bar for single operator valves only.

Consult "Precautions" before use, installation or service of MAC Valves.

OPTIONS

Sandwich flow controls available, consult factory.

92B-AAA-000-DM-DXXP-1DM

- For lights on valve, replace by B.
- For lights and diode on valve, replace by F.
- For lights and MOV on valve, replace by H.

TECHNICAL DATA

Fluid :	Compressed air, vacuum, inert gases	
Pressure range :	Internal pilot : 20 to 120 PSI	3 positions : 35 to 120 PSI
	External pilot : vacuum to 120 PSI	3 positions : 35 to 120 PSI
Pilot pressure :	20 to 120 PSI 3 positions : 35 to 120 PSI	
Lubrication :	Not required, if used select a medium aniline point lubricant (between 180°F to 210°F)	
Filtration :	40 µ	
Temperature range :	0°F to 120°F (-18°C to +50°C)	
Orifice :	6.2 mm	
Flow (at 6 bar, ΔP=1bar) :	1.0 C _v	
Coil :	General purpose class A, continuous duty, encapsulated	
Voltage range :	-15% to +10% of nominal voltage	
Protection :	NEMA 4	
Power :	- Inrush : 7.6 VA	Holding : 4.8 VA
	= 1.8 to 12.7 W	
Response times :	24 V= /5.4 W	Energize : 8 ms De-energize : 7 ms
	60Hz/2.9 W	Energize : 7-13 ms De-energize : 12-20 ms

Spare parts :
 • Pilot valve : DMB-DXXP-XXX-1 including mounting screws 35069 (x2) and seal 16544.
 • Pressure seal between valve and base : 16543. • Mounting screws valve to base (x2) : 35050. • Blanking plate : M-92002.

Options :
 • BSPP threads. • Isolation of inlet and/or exhaust. • Circuit bar for number of stations > 24.

DIMENSIONS

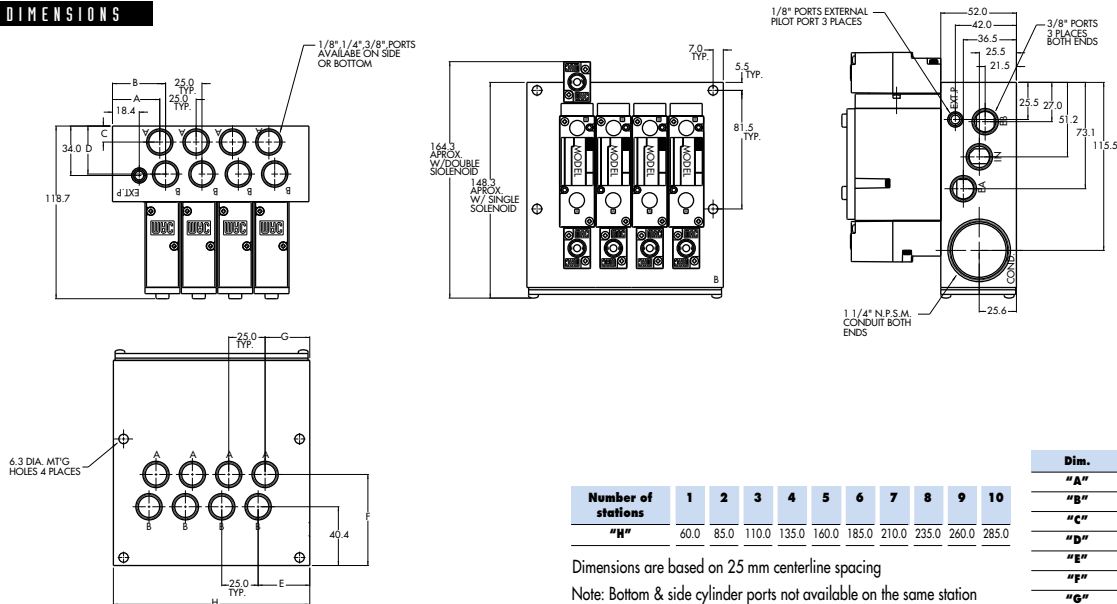

Consult "Precautions" before use, installation or service of MAC Valves.

Function	Port size	Flow [Max]	Circuit bar mounting
5/2 - 5/3 - 3/2	1/8 - 1/4 - 3/8	1.0C_v	add-on style

OPERATIONAL BENEFITS

1. The 4-way pilot develops maximum shifting forces both ways.
2. Memory spring available.
3. Balanced spool, immune to variations of pressure, also provides high flow.
4. Short stroke with high flow.
5. Bonded seal spool with minimum friction, shifting in a glass-like finished bore.
6. Pilot with balanced poppet, high flow, short and consistent response times.
7. Wiping effect eliminates sticking.
8. Long service life.



92B-xxx-000-DM-DxxP-xxx

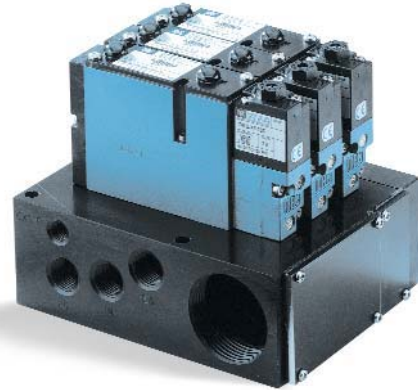

HOW TO ORDER VALVE FOR CIRCUIT BAR MOUNTING

SINGLE PRESSURE MODELS

Port size (see circuit bar)	5/2 Single operator	5/2 Double operator	5/3 Closed center	5/3 Open center	5/3 Pressure center
Valve less base	<input type="radio"/> 92B-AAA-000-DM-DxxP-xxx	<input type="radio"/> 92B-BAA-000-DM-DxxP-xxx	<input type="radio"/> 92B-EAA-000-DM-DxxP-xxx	<input type="radio"/> 92B-FAA-000-DM-DxxP-xxx	<input type="radio"/> 92B-GAA-000-DM-DxxP-xxx

DUAL PRESSURE MODELS (REQUIRES SANDWICH PRESSURE REGULATOR)

Port size (see circuit bar)	5/2 Single operator	5/2 Double operator
Valve less base	<input type="radio"/> 92B-CAA-000-DM-DxxP-xxx	<input type="radio"/> 92B-DAA-000-DM-DxxP-xxx

SOLENOID OPERATOR >

DM-DxxP-xxx*

XX Voltage	X Manual operator	XX Electrical connection
<input type="radio"/> JB 240/60, 220/50	<input type="radio"/> 1 Non-locking	<input type="radio"/> DM Plug-in
<input type="radio"/> JA 120/60, 110/50	<input type="radio"/> 2 Locking	<input type="radio"/> DG Plug-in w/ground
<input type="radio"/> JC 24/60, 24/50	<input type="radio"/> xx Other Options	
<input type="radio"/> FB 24VDC (1.8 W)		Note : Ground wire required for solenoids 30 volts and above.
<input type="radio"/> DA 24VDC (5.4 W)		<input type="radio"/> xx Other Options
<input type="radio"/> DF 24VDC (12.7 W)		
<input type="radio"/> xx Other Options		

CBM092B-01xxx-AOxx

Port size	Pilot air	Side cylinder ports (25 mm)	Bottom cylinder ports (25 mm)
1/8 NPTF	Internal	<input type="radio"/> CBM092B-01ABA-A0*xx	<input type="radio"/> CBM092B-01BBA-A0*xx
	Common external	<input type="radio"/> CBM092B-01CBA-A0*xx	<input type="radio"/> CBM092B-01DBA-A0*xx
1/4 NPTF	Internal	<input type="radio"/> CBM092B-01ABD-A0*xx	<input type="radio"/> CBM092B-01BBD-A0*xx
	Common external	<input type="radio"/> CBM092B-01CBD-A0*xx	<input type="radio"/> CBM092B-01DBD-A0*xx
3/8 NPTF	Internal	<input type="radio"/> CBM092B-01ABG-A0*xx	<input type="radio"/> CBM092B-01BBG-A0*xx
	Common external	<input type="radio"/> CBM092B-01CBG-A0*xx	<input type="radio"/> CBM092B-01DBG-A0*xx

Number of stations (03=3 stations)

Note : clic for valves mounted on base at the factory (add - 9 to the model number) for multi-pin connector (9, 15 or 25).

* If replaced by BO : circuit bar for single operator valves only.

Note : add-a-unit stations may be added to above bars. See page for model numbers

Consult "Precautions" before use, installation or service of MAC Valves.

OPTIONS

Sandwich flow controls available, consult factory.

92B-AAA-000-DM-DXXP-1DM

- For lights on valve, replace by B.
- For lights and diode on valve, replace by F.
- For lights and MOV on valve, replace by H.

**TECHNICAL
DATA**

Fluid :	Compressed air, vacuum, inert gases	
Pressure range :	Internal pilot : 20 to 120 PSI	3 positions : 35 to 120 PSI
	External pilot : vacuum to 120 PSI	3 positions : 35 to 120 PSI
Pilot pressure :	20 to 120 PSI 3 positions : 35 to 120 PSI	
Lubrication :	Not required, if used select a medium aniline point lubricant (between 180°F to 210°F)	
Filtration :	40 µ	
Temperature range :	0°F to 120°F (-18°C to +50°C)	
Orifice :	6.2 mm	
Flow (at 6 bar, ΔP=1bar) :	1.0 C _v	
Coil :	General purpose class A, continuous duty, encapsulated	
Voltage range :	-15% to +10% of nominal voltage	
Protection :	NEMA 4	
Power :	- Inrush : 7.6 VA	Holding : 4.8 VA
	= 1.8 to 12.7 W	
Response times :	24 V=5.4 W	Energize : 8 ms De-energize : 7 ms
	60Hz/2.9 W	Energize : 7-13 ms De-energize : 12-20 ms

Spare parts :

- Pilot valve : DMB-DXXP-XXX-1 including mounting screws 35069 (x2) and seal 16544.
- Pressure seal between valve and base : 16543. • Mounting screws valve to base (x2) : 35050. • Blanking plate : M-92002.
- End plate kit : M-92001-01 • Isolator disc between add-a-units : 28413.

Options :

- BSPP threads. • Isolation of inlet and/or exhaust. • Circuit bar for number of stations > 24.

DIMENSIONS

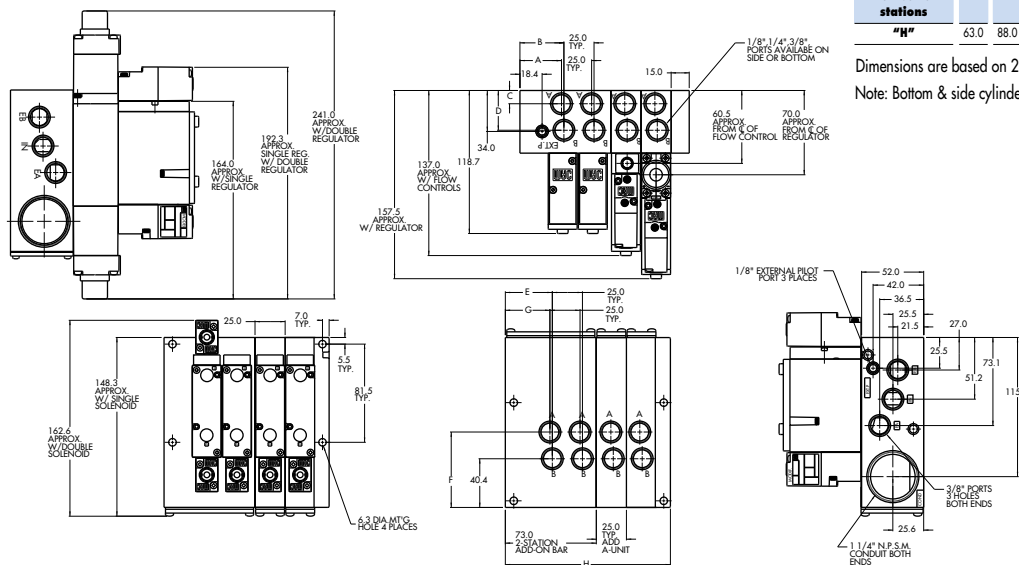

Number of stations	1	2	3	4	5	6	7	8	9	10
"H"	63.0	88.0	113.0	138.0	163.0	188.0	213.0	238.0	263.0	288.0

Dimensions are based on 25 mm centerline spacing

Note: Bottom & side cylinder ports not available on the same station

Dim.	1/8"	1/4"	3/8"
"A"	32.0	32.0	34.5
"B"	39.0	39.0	36.5
"C"	10.0	10.0	11.0
"D"	33.4	33.4	33.0
"E"	40.9	37.9	36.5
"F"	61.1	61.1	62.6
"G"	30.1	31.9	34.5

Consult "Precautions" before use, installation or service of MAC Valves.

Function	Port size	Flow [Max]	Circuit bar mounting
5/2 - 5/3 - 3/2	1/8 - 1/4 - 3/8	1.0C_v	add-a-unit stations for CBM092B

OPERATIONAL BENEFITS

1. The 4-way pilot develops maximum shifting forces both ways.
2. Memory spring available.
3. Balanced spool, immune to variations of pressure, also provides high flow.
4. Short stroke with high flow.
5. Bonded seal spool with minimum friction, shifting in a glass-like finished bore.
6. Pilot with balanced poppet, high flow, short and consistent response times.
7. Wiping effect eliminates sticking.
8. Long service life.



92B-xxx-000-DM-DxxP-xxx



HOW TO ORDER VALVE FOR CIRCUIT BAR MOUNTING

SINGLE PRESSURE MODELS

Port size (see circuit bar)	5/2 Single operator	5/2 Double operator	5/3 Closed center	5/3 Open center	5/3 Pressure center
Valve less base	<input type="radio"/> 92B-AAA-000-DM-DxxP-xxx	<input type="radio"/> 92B-BAA-000-DM-DxxP-xxx	<input type="radio"/> 92B-EAA-000-DM-DxxP-xxx	<input type="radio"/> 92B-FAA-000-DM-DxxP-xxx	<input type="radio"/> 92B-GAA-000-DM-DxxP-xxx

DUAL PRESSURE MODELS (REQUIRES SANDWICH PRESSURE REGULATOR)

Port size (see circuit bar)	5/2 Single operator	5/2 Double operator
Valve less base	<input type="radio"/> 92B-CAA-000-DM-DxxP-xxx	<input type="radio"/> 92B-DAA-000-DM-DxxP-xxx

SOLENOID OPERATOR >

DM-DxxP-xxx*

XX Voltage	X Manual operator	XX Electrical connection
<input type="radio"/> JB 240/60, 220/50	<input type="radio"/> 1 Non-locking	<input type="radio"/> DM Plug-in
<input type="radio"/> JA 120/60, 110/50	<input type="radio"/> 2 Locking	<input type="radio"/> DG Plug-in w/ground
<input type="radio"/> JC 24/60, 24/50	<input type="radio"/> xx Other Options	Note : Ground wire required for solenoids 30 volts and above.
<input type="radio"/> FB 24VDC (1.8 W)		<input type="radio"/> xx Other Options
<input type="radio"/> DA 24VDC (5.4 W)		
<input type="radio"/> DF 24VDC (12.7 W)		
<input type="radio"/> xx Other Options		

CBM092B-01xxx-AOxx

Port size	Side cylinder ports (25 mm)	Bottom cylinder ports (25 mm)
1/8 NPTF	<input type="radio"/> CBM092B-01ACA-A0*xx	<input type="radio"/> CBM092B-01BCA-A0*xx
1/4 NPTF	<input type="radio"/> CBM092B-01ACD-A0*xx	<input type="radio"/> CBM092B-01BCD-A0*xx
3/8 NPTF	<input type="radio"/> CBM092B-01ACG-A0*xx	<input type="radio"/> CBM092B-01BCG-A0*xx

Number of stations (01=1 stations). Available in one (1) or two (2) station lengths.
 Note : clic for valves mounted on base at the factory (add - 9 to the model number).
 when add-a-units are added to bars with a multi-pin connector, MOD SD03 should be included with add-a-unit model number.

* If replaced by BO : circuit bar for single operator valves only.

OPTIONS

Sandwich flow controls available, consult factory.

92B-AAA-000-DM-DXXP-1DM

- For lights on valve, replace by B.
- For lights and diode on valve, replace by F.
- For lights and MOV on valve, replace by H.

**TECHNICAL
DATA**

Fluid :	Compressed air, vacuum, inert gases	
Pressure range :	Internal pilot : 20 to 120 PSI	3 positions : 35 to 120 PSI
	External pilot : vacuum to 120 PSI	3 positions : 35 to 120 PSI
Pilot pressure :	20 to 120 PSI 3 positions : 35 to 120 PSI	
Lubrication :	Not required, if used select a medium aniline point lubricant (between 180°F to 210°F)	
Filtration :	40 µ	
Temperature range :	0°F to 120°F (-18°C to +50°C)	
Orifice :	6.2 mm	
Flow (at 6 bar, ΔP=1bar) :	1.0 C _v	
Coil :	General purpose class A, continuous duty, encapsulated	
Voltage range :	-15% to +10% of nominal voltage	
Protection :	NEMA 4	
Power :	- Inrush : 7.6 VA	Holding : 4.8 VA
	= 1.8 to 12.7 W	
Response times :	24 V=5.4 W	Energize : 8 ms De-energize : 7 ms
	60Hz/2.9 W	Energize : 7-13 ms De-energize : 12-20 ms

Spare parts : • Pilot valve : DMB-DXXP-XXX-1 including mounting screws 35069 (x2) and seal 16544.
• Pressure seal between valve and base : 16543. • Mounting screws valve to base (x2) : 35050. • Blanking plate : M-92002.

Options : • BSPP threads. • Isolation of inlet and/or exhaust. • Circuit bar for number of stations > 24.

DIMENSIONS

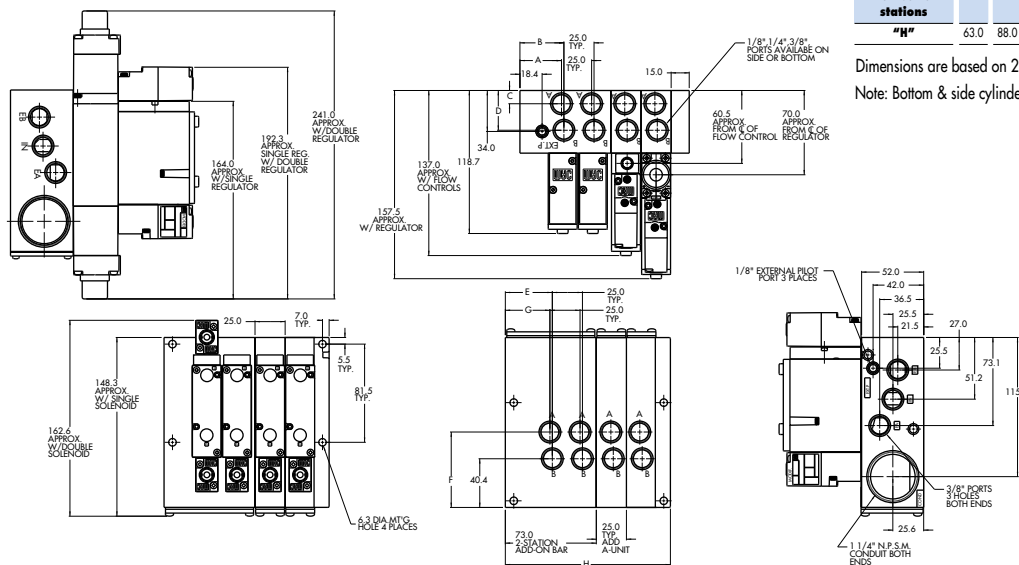

Number of stations	1	2	3	4	5	6	7	8	9	10
"H"	63.0	88.0	113.0	138.0	163.0	188.0	213.0	238.0	263.0	288.0

Dimensions are based on 25 mm centerline spacing
Note: Bottom & side cylinder ports not available on the same station

Dim.	1/8"	1/4"	3/8"
"A"	32.0	32.0	34.5
"B"	39.0	39.0	36.5
"C"	10.0	10.0	11.0
"D"	33.4	33.4	33.0
"E"	40.9	37.9	36.5
"F"	61.1	61.1	62.6
"G"	30.1	31.9	34.5



Section 2

Options



0 p t i o n s

Codification table for voltages / Wire length / Manual operator / Electrical connection

VALVE CODE ➤

DM-DXX X - X XX
1 2 3 4

OPTIONS AVAILABLE FOR

- pilot operated valves 400, 52 & 92 Series

1. VOLTAGE

- D XX X - X XX VOLTAGE

<input type="radio"/> DB	12 VDC (5.4 W)
<input type="radio"/> DC	12 VDC (7.5 W)
<input type="radio"/> DD	24 VDC (7.3 W)
<input type="radio"/> DE	12 VDC (12.7 W)
<input type="radio"/> DK	110 VDC (5.8 W)
<input type="radio"/> DJ	28 VDC (5.7 W)
<input type="radio"/> DL	64 VDC (6.0 W)
<input type="radio"/> DM	36 VDC (5.8 W)
<input type="radio"/> DN	6 VDC (6.0 W)
<input type="radio"/> DR	90 VDC (6.6 W)
<input type="radio"/> DS	110 VDC (7.3 W), 100 VDC (6.0 W)
<input type="radio"/> DT	75 VDC (5.6 W)
<input type="radio"/> DP	48 VDC (5.8 W)
<input type="radio"/> FA	12 VDC (1.8 W)
<input type="radio"/> FE	12 VDC (2.4 W)
<input type="radio"/> FF	24 VDC (2.4 W)
<input type="radio"/> JD	100/60, 100/50, 110/60

2. WIRE LENGTH

- D XX X - X XX WIRE LENGTH

<input type="radio"/> B	24"
<input type="radio"/> C	36"
<input type="radio"/> D	48"
<input type="radio"/> E	72"
<input type="radio"/> F	96"



3. MANUAL OPERATOR

- D XX X - X XX	MANUAL OPERATOR
<input type="radio"/> 0	No operator
<input checked="" type="radio"/> 1	Non-locking recessed
<input type="radio"/> 2	Locking recessed
<input type="radio"/> 3	Non-locking extended
<input type="radio"/> 4	Locking extended

4. ELECTRICAL CONNECTION

- D XX X - X XX	ELECTRICAL CONNECTION
<input type="radio"/> BA	Flying leads
<input type="radio"/> BK	BA with protection diode
<input type="radio"/> BL	BA with protection varistor
<input checked="" type="radio"/> CA	1/2" NPS conduit
<input type="radio"/> JB	Rectangular connector
<input type="radio"/> JD	Rectangular connector with light
<input type="radio"/> JM	Rectangular connector, male only
<input type="radio"/> KA	Square connector
<input type="radio"/> KB	Square connector with protection diode
<input type="radio"/> KC	Square connector with protection varistor
<input type="radio"/> KD	Square connector with light
<input type="radio"/> KE	Square connector with light and protection diode
<input type="radio"/> KF	Square connector with light and protection varistor
<input type="radio"/> KJ	Square connector (male only)
<input type="radio"/> KK	Square connector with protection diode (male only)
<input type="radio"/> KL	Square connector with protection varistor (male only)
<input type="radio"/> TA	Dual tabs
<input type="radio"/> TB	TA with protection diode
<input type="radio"/> TD	TA with light
<input type="radio"/> TE	TA with light and protection diode
<input type="radio"/> TJ	Dual tabs (male only)
<input type="radio"/> TK	TJ with protection diode
<input type="radio"/> TM	TJ with light
<input type="radio"/> TN	TJ with light and protection diode
<input type="radio"/> *DN	Plug-in with diode
<input type="radio"/> *DP	Plug-in with M.O.V.
<input type="radio"/> *DH	Plug-in with diode & ground
<input type="radio"/> *DJ	Plug-in with M.O.V & ground

* These options only apply to the 92 series. All others are for the 400 and 52 series.

MOD. S009

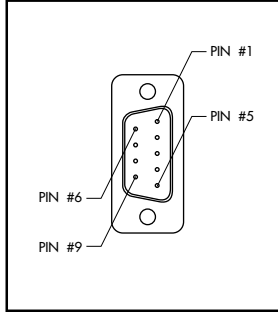

TECHNICAL DATA

- Type «SUB_D»
- Number of contacts : 9
- Solder termination (Dia. 0.6 mm/0.14 mm²/26-22 AWG)
- Operating current 5 A/contact
- Rated voltage 125 V~
- Temp. range -40° to +125°C
- Insulation resistance ≥ 5.0⁹ Ω
- Protection class IP40 (DIN 40050)
- Number of solenoids : 7 max.
- Max. 24 V=/5.4 W per solenoid
- 2 common wires

MOD. S015

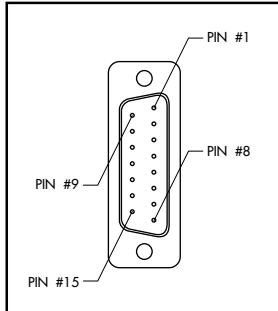

TECHNICAL DATA

- Type «SUB_D»
- Number of contacts : 15
- Solder termination (Dia. 0.6 mm/0.14 mm²/26-22 AWG)
- Operating current 5 A/contact
- Rated voltage 125 V~
- Temp. range -40° to +125°C
- Insulation resistance ≥ 5.0⁹ Ω
- Protection class IP40 (DIN 40050)
- Number of solenoids : 12 max.
- Max. 24 V=/5.4 W per solenoid
- 3 common wires

MOD. S025

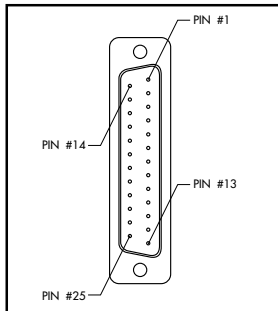

TECHNICAL DATA

- Type «SUB_D»
- Number of contacts : 25
- Solder termination (Dia. 0.6 mm/0.14 mm²/26-22 AWG)
- Operating current 5 A/contact
- Rated voltage 125 V~
- Temp. range -40° to +125°C
- Insulation resistance ≥ 5.0⁹ Ω
- Protection class IP40 (DIN 40050)
- Number of solenoids : 20 max.
- Max. 24 V=/5.4 W per solenoid
- 5 common wires

Note : Use desired MOD. number after circuit bar part number

Connector termination details

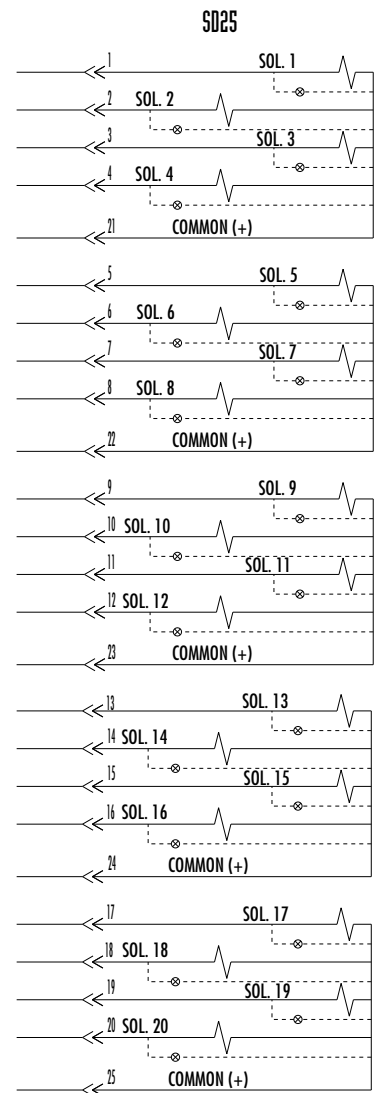
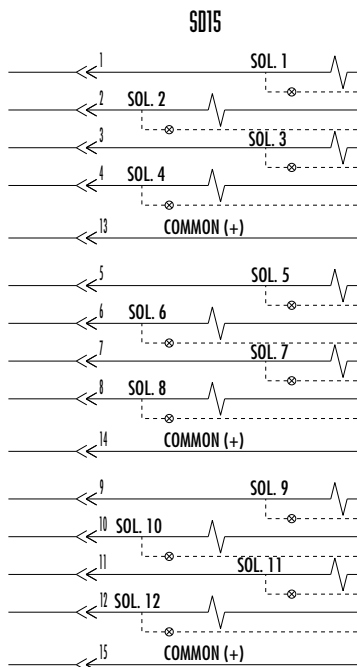
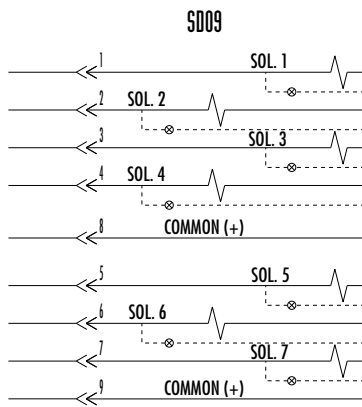
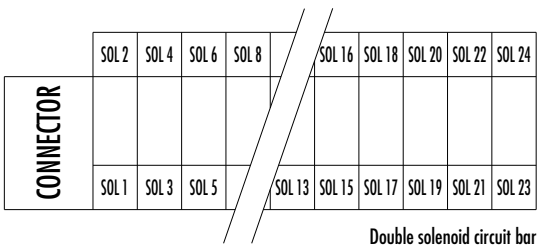
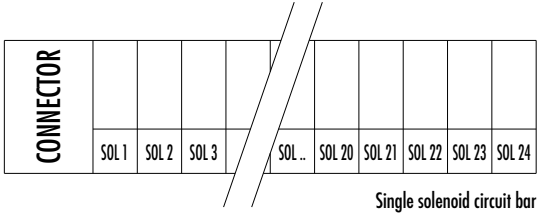

Circuit bar mounting

cylinder ports in valve	with shut-off valve
----------------------------	------------------------

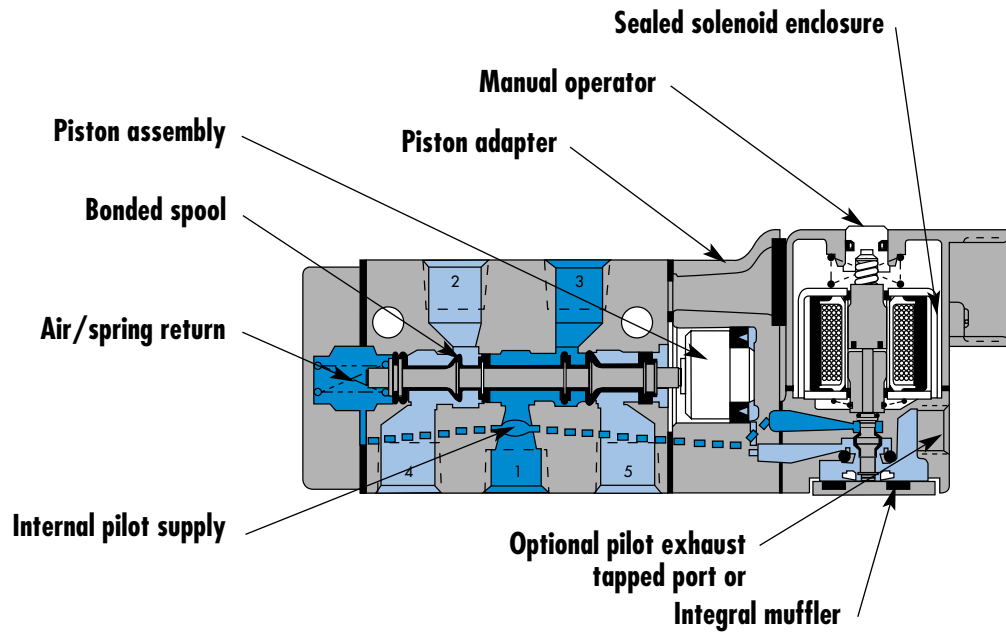

SERIES FEATURES

- Patented MACSOLENOID[®] with its non-burn out feature on AC service.
- Air/spring return on single solenoid valves.
- Use for lube or non-lube service.
- Optional low wattage DC solenoids down to 1 watt.
- Various types of manual operators and solenoid enclosures.
- 2 position or 3 position valve configurations.

Function	Port size	Flow [Max]	Circuit bar mounting
5/2 - 5/3	1/4"	1.3C_v	cylinder ports in valve

OPERATIONAL BENEFITS

- Balanced spool, immune to variations of pressure.
- Short stroke with high flow.
- The piston (booster) provides maximum shifting forces.
- Powerful return force thanks to the combination of mechanical and air springs.
- Bonded spool with minimum friction, shifting in a glass-like finished bore.
- Wiping effect eliminates sticking.
- Pilot valve with balanced poppet, high flow, short and consistent response times.
- Long service life.

Reset

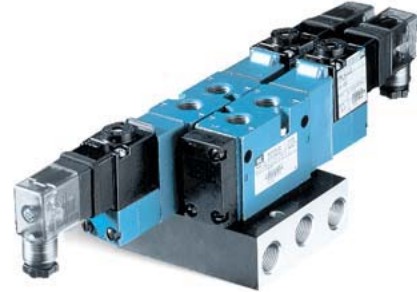

HOW TO ORDER

xxxx-PM-xxxxx-xxx

HOW TO ORDER VALVE FOR CIRCUIT BAR MOUNTING

Port size	5/2 Single operator	5/2 Double operator	5/3 Closed center	5/3 Open center	5/3 Pressure center
1/4" NPTF	<input type="radio"/> 811C-PM- xyzz -172	<input type="radio"/> 821C-PM- xyzz -172	<input type="radio"/> 825C-PM- xyzz -572	<input type="radio"/> 825C-PM- xyzz -672	<input type="radio"/> 825C-PM- xyzz -872

SOLENOID OPERATOR >

XX Y ZZ*

Voltage	Manual operator	Electrical connection
<input type="radio"/> 11 120/60, 110/50	<input type="radio"/> 1 Non-locking	<input type="radio"/> JB Rectangular connector
<input type="radio"/> 12 240/60, 220/50	<input type="radio"/> 2 Locking	<input type="radio"/> JD Rectangular connector with light
<input type="radio"/> 22 24/50, 24/60	<input type="radio"/> xx Other Options	<input type="radio"/> BA Flying leads (18")
<input type="radio"/> 59 24VDC (2.5 W)		<input type="radio"/> xx Other Options
<input type="radio"/> 87 24VDC (17.1 W)		
<input type="radio"/> 61 24VDC (8.5 W)		
<input checked="" type="radio"/> xx Other Options		

EBM800A-xxxx-xx

HOW TO ORDER CIRCUIT BAR**

Port size (Spacing 31 mm)	Standard circuit bar	Circuit bar with flow controls (2 per station)
3/8" NPTF	<input type="radio"/> EBM800A-001A-xx	<input type="radio"/> EBM800A-002A-xx

Number of stations (03=3 stations)

Other options available. Consult factory.

Note : clic for valves mounted on base at the factory (add - 9 to the model number).

T E C H N I C A L
D A T A

Fluid :	Compressed air, vacuum, inert gases	
Pressure range :	Internal pilot : single operator and 3 positions : 20 to 150 PSI	double operator : 10 to 150 PSI
	External pilot : vacuum to 200 PSI	
Pilot pressure :	Single operator and 3 positions : 20 to 150 PSI	Double operator : 20 to 150 PSI
Lubrication :	Not required, if used select a medium aniline point lubricant (between 180°F to 210°F)	
Filtration :	40 µ	
Temperature range :	0°F to 120°F (-18°C to +50°C)	
Orifice :	7 mm	
Flow (at 6 bar, ΔP=1bar) :	1/4" : 1.3 C _v	
Coil :	General purpose class A, continuous duty, encapsulated	
Voltage range :	-15% to +10% of nominal voltage	
Protection :	NEMA 4	
Power :	~ Inrush : 14.8 VA	Holding : 10.9 VA
	= 1 to 17.1 W	
Response times :	24 V= /8.5 W	Energize : 8 ms De-energize : 10ms
	60Hz/6 W	Energize : 5-11 ms De-energize : 9-16 ms

Spare parts :

- Pilot valve : PME.XXYZZ. • Mounting screw pilot to main valve : 34364. • Blanking plate : M-08008.
- Mounting screw valve to bar (x2) : 35249. • Flow control : N08006.

Options :

- BSPP threads. • Isolation of inlet and/or exhaust. • Explosion-proof model.

D I M E N S I O N S

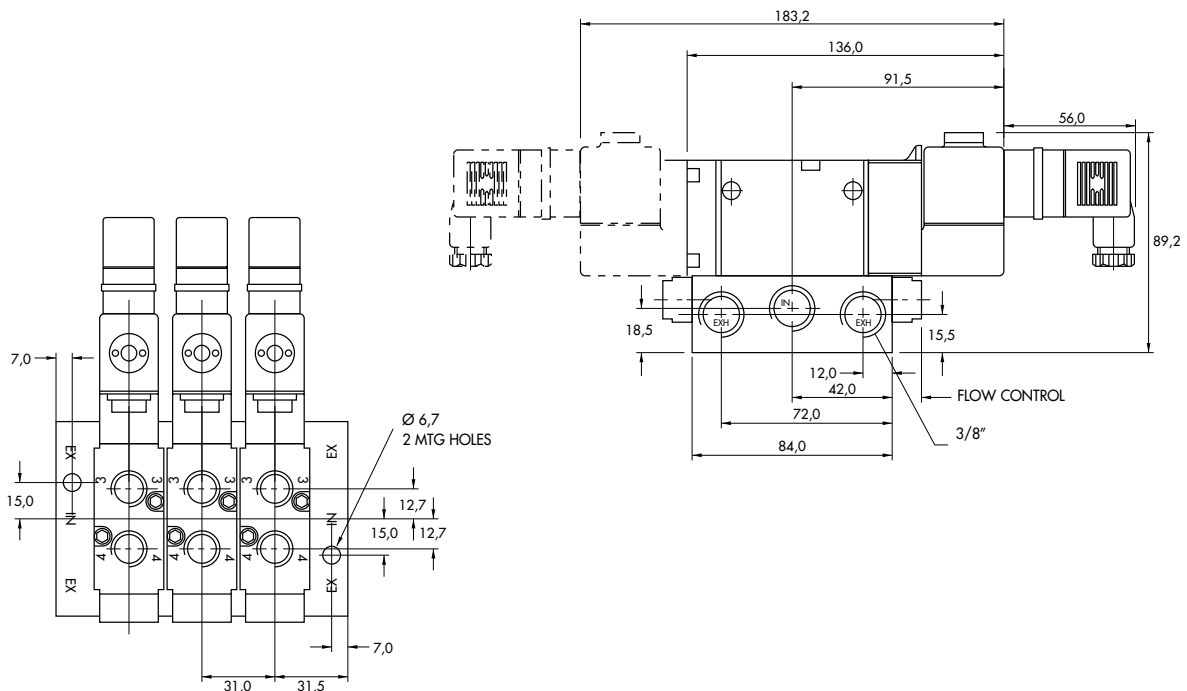

Function	Port size	Flow [Max]	Circuit bar mounting
5/2 - 5/3	1/4"	1.3C_v	with shut-off valve

OPERATIONAL BENEFITS

- Balanced spool, immune to variations of pressure.
- Short stroke with high flow.
- The piston (booster) provides maximum shifting forces.
- Powerful return force thanks to the combination of mechanical and air springs.
- Bonded spool with minimum friction, shifting in a glass-like finished bore.
- Wiping effect eliminates sticking.
- Pilot valve with balanced poppet, high flow, short and consistent response times.
- Long service life.

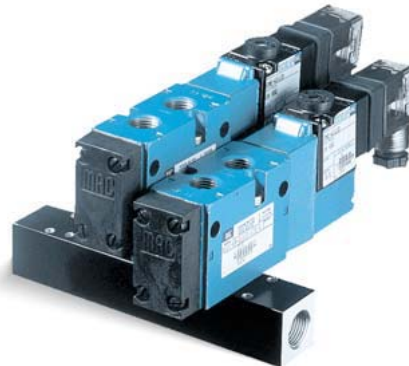

HOW TO ORDER

xxxx-PM-xxxxx-xxx

HOW TO ORDER VALVE FOR CIRCUIT BAR MOUNTING

Port size	5/2 Single operator	5/2 Double operator	5/3 Closed center	5/3 Open center	5/3 Pressure center
1/4" NPTF	<input type="radio"/> 811C-PM- xyzz -172	<input type="radio"/> 821C-PM- xyzz -172	<input type="radio"/> 825C-PM- xyzz -572	<input type="radio"/> 825C-PM- xyzz -672	<input type="radio"/> 825C-PM- xyzz -872

SOLENOID OPERATOR >

XX Y ZZ*

Voltage	Manual operator	Electrical connection
<input type="radio"/> 11 120/60, 110/50	<input type="radio"/> 1 Non-locking	<input type="radio"/> JB Rectangular connector
<input type="radio"/> 12 240/60, 220/50	<input type="radio"/> 2 Locking	<input type="radio"/> JD Rectangular connector with light
<input type="radio"/> 22 24/50, 24/60	<input type="radio"/> xx Other Options	<input type="radio"/> BA Flying leads (18")
<input type="radio"/> 59 24VDC (2.5 W)		<input type="radio"/> xx Other Options
<input type="radio"/> 87 24VDC (17.1 W)		
<input type="radio"/> 61 24VDC (8.5 W)		
<input type="radio"/> xx Other Options		

EBI800A-xxxx-xx

HOW TO ORDER CIRCUIT BAR**

Port size (Spacing 31 mm)	w/o inlet shut-off valve	w/ inlet shut-off valve
3/8" NPTF	<input type="radio"/> EBI800A-001A-xx	<input type="radio"/> EBI800A-002A-xx

Number of stations (03=3 stations)

Other options available. Consult factory.

Note : clic for valves mounted on base at the factory (add - 9 to the model number).

T E C H N I C A L
D A T A

Fluid :	Compressed air, vacuum, inert gases		
Pressure range :	Internal pilot : single operator and 3 positions : 20 to 150 PSI	double operator : 10 to 150 PSI	
	External pilot : vacuum to 200 PSI		
Pilot pressure :	Single operator and 3 positions : 20 to 150 PSI	Double operator : 20 to 150 PSI	
Lubrication :	Not required, if used select a medium aniline point lubricant (between 180°F to 210°F)		
Filtration :	40 µ		
Temperature range :	0°F to 120°F (-18°C to +50°C)		
Orifice :	7 mm		
Flow (at 6 bar, ΔP=1bar) :	1/4" : 1.3 C _v		
Coil :	General purpose class A, continuous duty, encapsulated		
Voltage range :	-15% to +10% of nominal voltage		
Protection :	NEMA 4		
Power :	~ Inrush : 14.8 VA	Holding : 10.9 VA	
	= 1 to 17.1 W		
Response times :	24 V= /8.5 W	Energize : 8 ms	De-energize : 10ms
	60Hz/6 W	Energize : 5-11 ms	De-energize : 9-16 ms

Spare parts :

- Pilot valve : PME-XYZZ.
- Mounting screw pilot to main valve : 34364.
- Blanking plate : M-08011.
- Shut-off valve : M-08010.
- Mounting screw valve to bar (x2): 35249.

Options :

- BSPP threads.
- Isolation of inlet and/or exhaust.
- Explosion-proof model.

D I M E N S I O N S

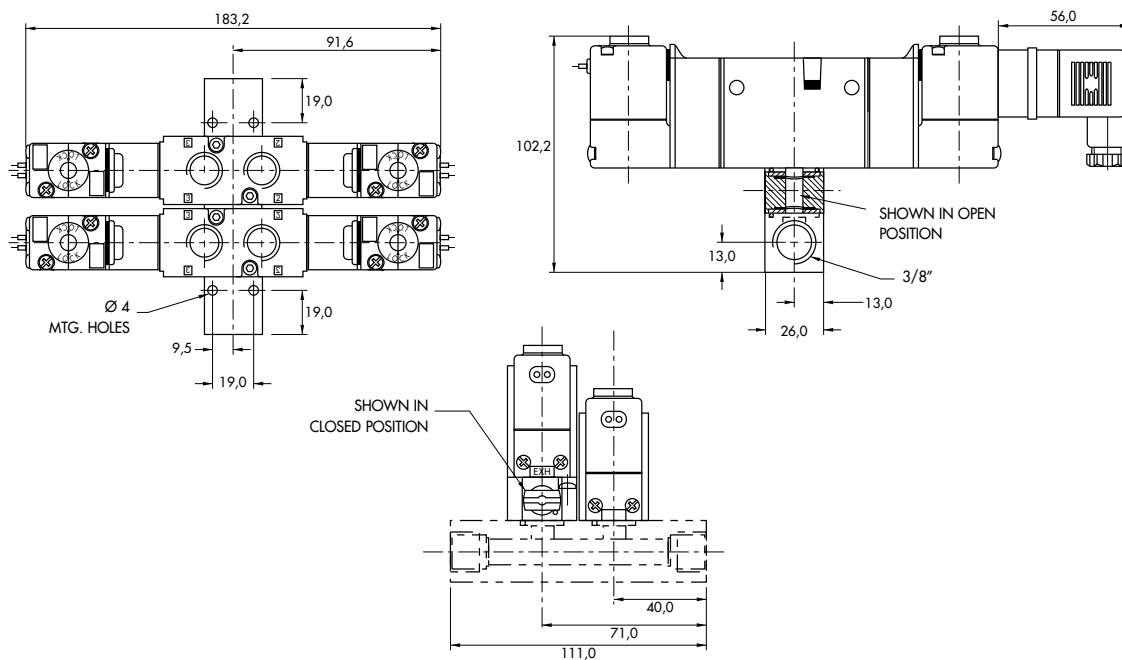



Section 2

Options



Codification table for voltages / Manual operator / Electrical connection / Wire length

VALVE CODE ➤ $\frac{-XX}{1} \frac{Y}{2} \frac{ZZ}{3} \frac{(-VV)}{4}$

OPTIONS AVAILABLE FOR

- valves type 800 Series

1. VOLTAGE

- XX Y ZZ	VOLTAGE
<input type="radio"/> 11	120/60 - 110/50
<input type="radio"/> 12	240/60 - 220/50
<input type="radio"/> 13	100/60 - 100/50
<input type="radio"/> 15	200/60 - 200 V~/50 Hz
<input type="radio"/> 16	10/60
<input type="radio"/> 20	6/60
<input type="radio"/> 21	12/50 - 12/60
<input type="radio"/> 22	24/60 - 24/50
<input type="radio"/> 23	32/60 - 32/50
<input type="radio"/> 24	48/60 - 42/50
<input type="radio"/> 26	380/50, 440/50 -440/60, 480/60-CLSF
<input type="radio"/> 29	200/60
<input type="radio"/> 34	127/50 - 120/50
<input type="radio"/> 35	48/50
<input type="radio"/> 36	16/60
<input type="radio"/> 81	24/50
<input type="radio"/> 50	24 VDC (6W)
<input type="radio"/> 51	24 VDC (4W)
<input type="radio"/> 54	12 VDC (4W)
<input type="radio"/> 55	12 VDC (6W)
<input type="radio"/> 57	12 VDC (2.5W)
<input type="radio"/> 59	24 VDC (2.5W)
<input type="radio"/> 60	12 VDC (8.5W)
<input type="radio"/> 61	24 VDC (8.5W)
<input type="radio"/> 64	6 VDC (6W)
<input type="radio"/> 65	32 VDC (7W)
<input type="radio"/> 66	48 VDC (5.8W)
<input type="radio"/> 67	64 VDC (7.5W)
<input type="radio"/> 68	120 VDC (6.4W)
<input type="radio"/> 75	90 VDC (8.8W)
<input type="radio"/> 76	100 VDC (6.9W)
<input type="radio"/> 84	125 VDC (10.9W)
<input type="radio"/> 87	24 VDC (17.1W)
<input type="radio"/> 88	12 VDC (17.4W)
<input type="radio"/> 89	36 VDC (18.8W)
<input type="radio"/> 90	28 VDC (8.2W)
<input type="radio"/> 91	6 VDC (10.6W)
<input type="radio"/> 92	190 VDC (6.5W)
<input type="radio"/> 94	3 VDC (7W)
<input type="radio"/> 95	38 VDC (6.4W)
<input type="radio"/> A1	24 VDC (1.0W)
<input type="radio"/> A2	12 VDC (1.0W)
<input type="radio"/> A3	9 VDC (1.0W)

MOD. DD01 : Protection diode (DC)

MOD. MOV1 : Protection varistor (AC)

MOD. DD01 : max. 8,5 W

MOD. MOV1 : max. 8,5 W

* Voltages are CLSF only



2. MANUAL OPERATOR

- XX	Y	ZZ	MANUAL OPERATOR
<input type="radio"/>	0		No operator
<input type="radio"/>	1		Non-locking recessed
<input type="radio"/>	2		Locking recessed
<input type="radio"/>	3		Non-locking extended
<input type="radio"/>	4		Locking extended

3. ELECTRICAL CONNECTION

- XX	Y	ZZ	ELECTRICAL CONNECTION
<input type="radio"/>	AA		Wiring box with 1/2" NPS conduit
<input type="radio"/>	BA		Flying leads
<input type="radio"/>	CA		1/2" NPS conduit
<input type="radio"/>	CC		1/2" NPT conduit
<input type="radio"/>	FA		Military type 2 PIN
<input type="radio"/>	GA		Military type 3 PIN
<input type="radio"/>	HA		AA with ground wire
<input type="radio"/>	JA		Square connector
<input type="radio"/>	JB		Rectangular connector
<input type="radio"/>	JC		Square connector with light
<input type="radio"/>	JD		Rectangular connector with light
<input type="radio"/>	JJ		Square connector, male only
<input type="radio"/>	JM		Rectangular connector, male only
<input type="radio"/>	NA		CA with ground wire
<input type="radio"/>	NC		CC with ground wire
<input type="radio"/>	RA		3/8" NPS conduit
<input type="radio"/>	CD		20 mm conduit

4. WIRE LENGTH

- XX	Y	ZZ (-VV)	WIRE LENGTH
<input type="radio"/>	AA		18"
<input type="radio"/>	AB		24"
<input type="radio"/>	AD		36"
<input type="radio"/>	AE		48"
<input type="radio"/>	AF		72"
<input type="radio"/>	AG		6"
<input type="radio"/>	AR		12"
<input type="radio"/>	AU		120"
<input type="radio"/>	BA		60"
<input type="radio"/>	BB		144"

MOD. S009

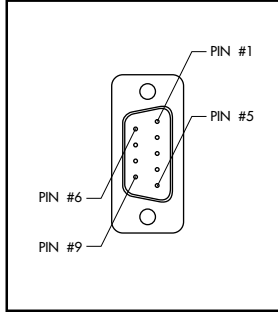

TECHNICAL DATA

- Type «SUB_D»
- Number of contacts : 9
- Solder termination (Dia. 0.6 mm/0.14 mm²/26-22 AWG)
- Operating current 5 A/contact
- Rated voltage 125 V~
- Temp. range -40° to +125°C
- Insulation resistance ≥ 5.0⁹ Ω
- Protection class IP40 (DIN 40050)
- Number of solenoids : 7 max.
- Max. 24 V=/5.4 W per solenoid
- 2 common wires

MOD. S015

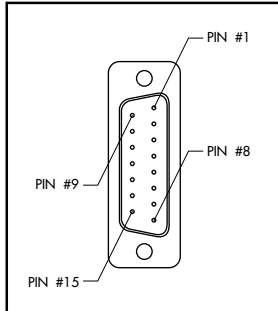

TECHNICAL DATA

- Type «SUB_D»
- Number of contacts : 15
- Solder termination (Dia. 0.6 mm/0.14 mm²/26-22 AWG)
- Operating current 5 A/contact
- Rated voltage 125 V~
- Temp. range -40° to +125°C
- Insulation resistance ≥ 5.0⁹ Ω
- Protection class IP40 (DIN 40050)
- Number of solenoids : 12 max.
- Max. 24 V=/5.4 W per solenoid
- 3 common wires

MOD. S025

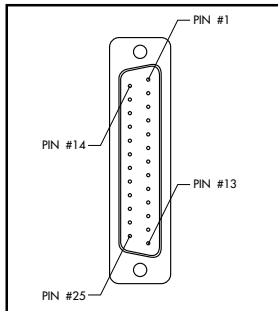

TECHNICAL DATA

- Type «SUB_D»
- Number of contacts : 25
- Solder termination (Dia. 0.6 mm/0.14 mm²/26-22 AWG)
- Operating current 5 A/contact
- Rated voltage 125 V~
- Temp. range -40° to +125°C
- Insulation resistance ≥ 5.0⁹ Ω
- Protection class IP40 (DIN 40050)
- Number of solenoids : 20 max.
- Max. 24 V=/5.4 W per solenoid
- 5 common wires

Note : Use desired MOD. number after circuit bar part number

Connector termination details

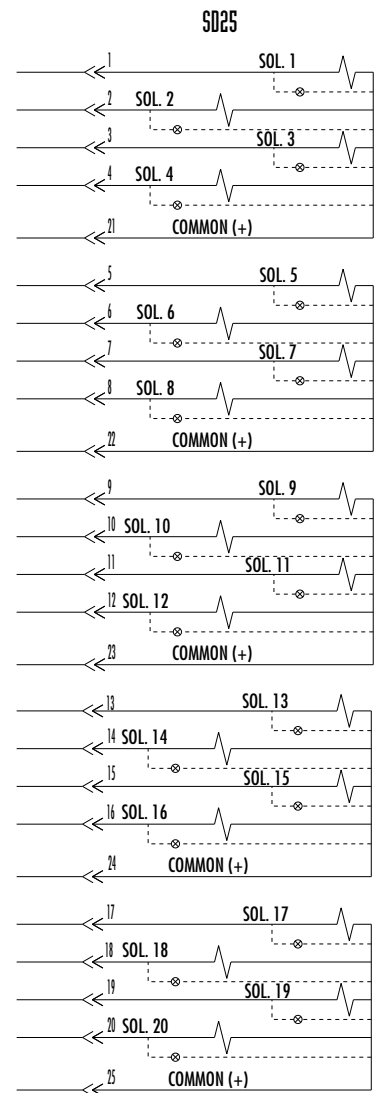
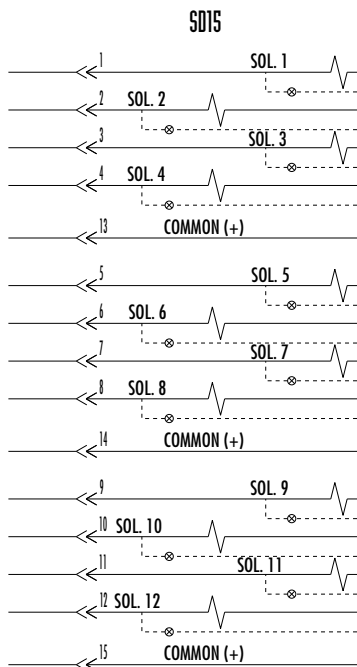
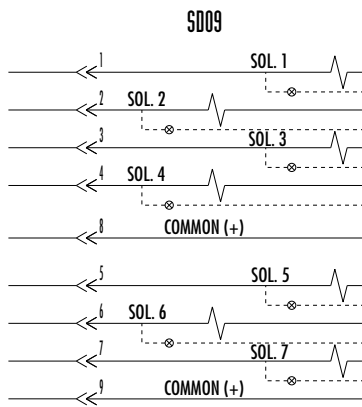
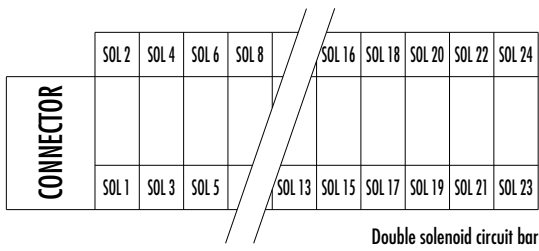
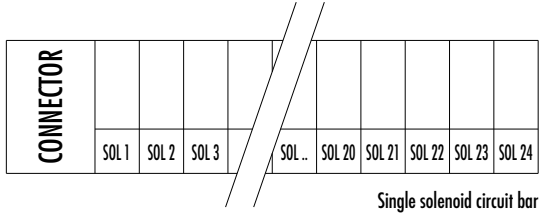

PRECAUTIONS AND WARNINGS CONCERNING THE APPLICATION, INSTALLATION AND SERVICE OF MAC VALVES AND OTHER MAC VALVES PRODUCTS

The warnings and precautions below are important to be read and understood before designing into a system any MAC Valves products, and before installing or servicing any MAC Valves product. Improper use, installation or servicing of any MAC Valves product in some systems could create a hazard to personnel or equipment. No distinction in importance should be made between the terms warnings and precautions.

WARNING :

Under no circumstances are MAC Valves products to be used in any application or in any manner where failure of the MAC Valves product to operate as intended could in any way jeopardize the safety of the operator or any other person or property.

- Do not operate outside of pressure range listed on a valve label or outside of the designated temperature range.
- Air supply must be clean and dry. Moisture or contamination can affect proper operation of the valve.
- Before attempting to repair, adjust or clean a MAC Valves product, consult catalog, parts & operation sheet, or factory for proper maintenance procedures, lubrication and cleaning agents. Never attempt to repair or perform other maintenance with air pressure to the valve.
- If air line lubrication is used do not use any lubrication other than those recommended in the catalog, parts & operation sheet or by the factory.

APPLICATION PRECAUTIONS :

INDUSTRIAL USE -

- MAC Valve products are intended for general use in industrial pneumatic and/or vacuum systems. They are general purpose industrial products with literally thousands of different applications in industrial systems. These products are not inherently dangerous, but they are only a component of an overall system. The system in which they are used must provide adequate safeguards to prevent injury or damage in the event failure occurs, whether it be failure of switches, regulators, cylinders, valves or any other component.

POWER PRESSES -

MAC Valve products are not designed nor intended to be used to operate and/or control the operation of clutch and/or brake systems on power presses. There are special products on the market for such use.

2-POSITION VALVES -

Some MAC valves are 2-position, 4-way valves. When air is supplied to the inlet port(s) of these valves, there will always be a flow path from the inlet to one of the outlets regardless of which of the two positions the valve is situated. Therefore, if pressurized air retained in the system would present a hazard in the application or servicing of the valve or system, a separate method in the system must be provided to remove the trapped air.

3- POSITION VALVES-

Some MAC valves are 3-position, 4-way valves. These valves are either double solenoid or double remote air operated.

If either of the two operators is in control, air supplied to the inlet port(s) will pass through the valve to one of the outlets as on 2-position, 4-way valves. However, if neither operator is in control, the valve moves to a center position. Listed below are the various center position functions :

A. CLOSED CENTER-

With this type valve, when in the center position all ports are blocked (inlets and exhausts) meaning the air at both outlet ports is trapped. If trapping the air in both outlet ports would present a hazard in the application or servicing, a separate method in the system must be provided to remove the trapped air or this type valve should not be used.

B. OPEN CENTER-

With this type valve, when in the center position, the inlet port(s) is blocked and the two outlet ports are open to the exhaust port(s) of the valve. If having no air in either outlet port would present a hazard in the application or servicing, this type valve should not be used.

C. PRESSURE CENTER-

With this type valve, when in the center position, the inlet port(s) is connected to both outlet ports of the valve. If having pressurized air to either or both outlet ports would present a hazard in the application or servicing of the valve or system, a separate method in the system must be provided to remove the retained air or this type valve should not be used.

OPERATING SPECIFICATIONS -

MAC Valves products are to be installed only on applications that meet all operating specifications described in the MAC catalog for the MAC Valves product.

MANUAL OPERATORS-

Most MAC valves can be ordered with manual operators. Manual operators when depressed, are designed to shift the valve to the same position as would the corresponding solenoid or remote air pilot operator if it were activated. Care must be taken to order a type, if any, that will be safe for the physical location of the manual operator in the system. If intentional or accidental operation of a valve by a manual operator could cause personal injury or property damage, a manual operator should not be used.

REMOTE AIR OPERATED VALVES

Pilot valves supplying signal pressure to remote air operated valves should be 3-way valves with adequate supply and exhaust capacity to provide positive pressurizing and exhausting of the pilot supply line. Pilot lines should be open to exhaust when valves are deenergized.

INSTALLATION PRECAUTIONS :

- A. Do not install any MAC Valves product without first turning off air (bleed system completely) and electricity to the machine.
- B. MAC Valves products should only be installed by qualified, knowledgeable personnel who understand how the specific valve is to be pneumatically piped and electrically connected (where applicable). Flow paths through the valve are shown in the catalog and on the valve by use of ANSI or ISO type standard graphic symbols. Do not install unless these symbols and the valve functions and operations are thoroughly understood.
- C. If air line lubrication is used do not use any lubrication other than those recommended in the catalog, parts & operation sheet or by the factory.

SERVICE PRECAUTIONS :

- A. Do not service or remove from service any MAC Valves product without first shutting off both the air and electricity to the valve and making certain no pressurized air which could present a hazard is retained in the system.
- B. MAC Valves products should only be serviced or removed from service by qualified, knowledgeable personnel who understand how the specific product is used and/or how the specific valve is piped and used and whether there is air retained in the connecting lines to the valve or electric power still connected to the valve.
- C. Before attempting to repair, adjust or clean a MAC Valves product, consult catalog, parts & operation sheet, or factory for proper maintenance procedures, lubrication and cleaning agents. Never attempt to repair or perform other maintenance with air pressure to the valve.
- D. MAC Valves products are never to be stepped on while working on a machine. Damage to a MAC valve, or other product or lines to the product (either air or electrical lines) or accidental activation of a manual operator on the valve could result in personal injury or property damage.

MAC VALVES Warranty, Warranty Limitations, Flat Rate Rebuild Program

The MAC Valves organization has established a reputation over many years for fulfilling the needs and requirements of the users of its products. All MAC Valves are quality products specifically designed and built for long and rugged service. For this reason, MAC Valves is able to provide the Buyer a limited warranty.

WARRANTY:

MAC Valves, Inc. hereby warrants to Buyer that, for a period of 18 months from the original date of shipment of each valve from our factory ("Warranty Period"), such valve will be free from significant defects in material and workmanship and will conform to all specifications agreed to by MAC Valves, Inc.. In addition, MAC Valves, Inc. warrants that the electrical coils on such valves will be free from significant defects in material and workmanship for their normal useful life. EXCEPT FOR THESE LIMITED WARRANTIES, MAC VALVES, INC. EXPRESSLY DISCLAIMS ALL REPRESENTATIONS AND WARRANTIES OF ANY KIND (WHETHER EXPRESS, IMPLIED OR ARISING BY OPERATION OF LAW) WITH RESPECT TO THE VALVES, INCLUDING, WITHOUT LIMITATION, ANY WARRANTIES OR REPRESENTATIONS AS TO MERCHANTABILITY, FITNESS FOR A PARTICULAR PURPOSE OR ANY OTHER MATTER. THIS SECTION SURVIVES THE EXPIRATION, TERMINATION OR CANCELLATION OF ANY AGREEMENTS BETWEEN THE PARTIES RELATING TO THE PURCHASE OF THE VALVES.

WARRANTY LIMITATIONS:

This Warranty does not apply where the valves have been (i) subjected to abuse, misuse, damage, neglect, negligence, accident, improper testing, improper installation, improper storage, improper handling, abnormal physical stress, abnormal environmental condition, or use contrary to any instructions issued by MAC Valves, Inc.; (ii) modified, reconstructed, repaired, or altered by persons other than MAC Valves, Inc. or its authorized representative; or (iii) used with any third-party product, hardware, software or other product that has not been previously approved in writing by MAC Valves, Inc. Additionally, this Warranty does not cover claims for labor, material, time or transportation, and does not apply to loss or damage caused by fire, theft, riot, explosion, labor dispute, act of God, or other causes beyond the control of MAC Valves, Inc.

EXCLUSIVE REMEDY:

The Buyer's sole remedy under this Warranty is limited to the replacement or rebuilding of any valve which does not conform to the warranties provided herein or, in MAC Valves, Inc.'s sole discretion, refund of the purchase price for the non-conforming valve. Buyer's remedy is conditioned on Buyer's compliance with its obligations under this Warranty. Valves that Buyer believes do not conform to this Warranty must be returned (with or without bases) transportation prepaid and received at our factory within the Warranty Period. If MAC Valves, Inc. determines that the valve is non-conforming and is otherwise covered by this Warranty, the rebuilt or replaced valve will be returned to the customer at the expense of MAC Valves, Inc., and will carry the same warranties as provided under the Flat Rate Rebuild Program described below. MAC VALVES, INC. WILL NOT BE RESPONSIBLE FOR ANY INCIDENTAL, SPECIAL, EXEMPLARY OR CONSEQUENTIAL DAMAGES, INCLUDING WITHOUT LIMITATION DIRECT AND INDIRECT LOST PROFITS, REGARDLESS OF WHETHER THOSE DAMAGES WERE FORESEEABLE.

THE FLAT REBUILD PROGRAM:

Valves no longer covered by the MAC Warranty may be eligible for a one-time rebuild under the MAC Valves, Inc. Flat Rate Rebuild Program. Our constant research and testing program is dedicated to extending the life of our valves and maximizing their reliability under the most adverse conditions. Valves returned under this limited program are completely disassembled, inspected, rebuilt to current operating standards whenever possible, tested and returned within a few weeks for a nominal flat rate charge. All rebuilt valves carry the same warranty described (in our MAC Warranty) for new valves for a warranty period of 90 days from the date of shipment from our factory.

Valves that have gone through the one-time rebuild will have been marked with a letter "R" as part of the date stamp (This is an example of a rebuild date stamp from this month E(May)17(Year)Tester Symbol R(Indicates Rebuild)).



Please note that any valves sent back for subsequent rebuild that have already been through the program previously (indicated by the "R") will not be eligible for additional rebuild.

Алматы (7273)495-231
Ангарск (3955)60-70-56
Архангельск (8182)63-90-72
Астрахань (8512)99-46-04
Барнаул (3852)73-04-60
Белгород (4722)40-23-64
Благовещенск (4162)22-76-07
Брянск (4832)59-03-52
Владивосток (423)249-28-31
Владикавказ (8672)28-90-48
Владимир (4922)49-43-18
Волгоград (844)278-03-48
Вологда (8172)26-41-59
Воронеж (473)204-51-73
Екатеринбург (343)384-55-89

Иваново (4932)77-34-06
Ижевск (3412)26-03-58
Иркутск (395)279-98-46
Казань (843)206-01-48
Калининград (4012)72-03-81
Калуга (4842)92-23-67
Кемерово (3842)65-04-62
Киров (8332)68-02-04
Коломна (4966)23-41-49
Кострома (4942)77-07-48
Краснодар (861)203-40-90
Красноярск (391)204-63-61
Курск (4712)77-13-04
Курган (3522)50-90-47
Липецк (4742)52-20-81

Магнитогорск (3519)55-03-13
Москва (495)268-04-70
Мурманск (8152)59-64-93
Набережные Челны (8552)20-53-41
Нижний Новгород (831)429-08-12
Новокузнецк (3843)20-46-81
Ноябрьск (3496)41-32-12
Новосибирск (383)227-86-73
Омск (3812)21-46-40
Орел (4862)44-53-42
Оренбург (3532)37-68-04
Пенза (8412)22-31-16
Петрозаводск (8142)55-98-37
Псков (8112)59-10-37
Пермь (342)205-81-47

Ростов-на-Дону (863)308-18-15
Рязань (4912)46-61-64
Самара (846)206-03-16
Санкт-Петербург (812)309-46-40
Саратов (845)249-38-78
Севастополь (8692)22-31-93
Саранск (8342)22-96-24
Симферополь (3652)67-13-56
Смоленск (4812)29-41-54
Сочи (862)225-72-31
Ставрополь (8652)20-65-13
Сургут (3462)77-98-35
Сыктывкар (8212)25-95-17
Тамбов (4752)50-40-97
Тверь (4822)63-31-35

Тольятти (8482)63-91-07
Томск (3822)98-41-53
Тула (4872)33-79-87
Тюмень (3452)66-21-18
Ульяновск (8422)24-23-59
Улан-Удэ (3012)59-97-51
Уфа (347)229-48-12
Хабаровск (4212)92-98-04
Чебоксары (8352)28-53-07
Челябинск (351)202-03-61
Череповец (8202)49-02-64
Чита (3022)38-34-83
Якутск (4112)23-90-97
Ярославль (4852)69-52-93

Россия +7(495)268-04-70

Казахстан +7(7172)727-132

Киргизия +996(312)96-26-47

<https://mac.nt-rt.ru> || mcp@nt-rt.ru